



# Ersatzteilkatalog

Mercruiser S. 582 - S. 741

OMC S. 742 - S. 810

Volvo Penta S. 811 - S. 864

SEA RAY		
MODEL NO.	S/N	YEAR
3.0L	B787205-B917529	1988
4.3L	B785483-B921276	1988
4.3LX	B785981-B922330	1988
5.7L	B784799-B917017	1988
SRX5.7L, 350 Mag	B785241-B919012	1988
SRX7.4L, 454 Mag Alpha	B785149-B924857	1988
SRX7.4L-H, 454 Mag Bravo	B721206-B919343	1988

STERN DRIVES		
MODEL NO.	S/N	YEAR
SRX7.4L, Alpha	B803866-C348032	1988
SRX7.4L-H, Bravo	B803872-B999972	1988

INBOARD ENGINES		
MODEL NO.	S/N	YEAR
5.7L	B788204-B919356	1988
7.4L	B788179-B913769	1988

RENAULT 4 CYLINDER (STERN DRIVE)		
MODEL	S/N	YEAR
60	1887079-2049044	1965-68
80	2049045-2851423	1966-69
90	2851424-3226957	1970-72

GM 4 CYLINDER (STERN DRIVE)		
MODEL	S/N	YEAR
110	1537370-2044033	1963-66
120	1666601-3377340	1964-72
120	3377341-3770649	1972-73
120	3770650-4952700	1974-77
120	4952701-5192048	1978
120	5192049-6229717	1979-82
120	6229718-6853913	1983-84
120	6853914-B531853	1985-86
120/2.5L	B531854-C853255	1987-89
140	2508261-6229717	1968-82
140/3.0L	6229718-C856558	1982-89
3.0L/LX	C856559-UP	1990-UP

MERCURY MARINE 4 CYLINDER (STERN DRIVE)		
MODEL	S/N	YEAR
470 (2bbl.)	4208730-5520114	1976-79
470 (2bbl.)	5520115-6218036	1980-82
470 (2bbl.)	6218037-6916778	1983-84
170 (2bbl.)	6916779-UP	1985-86
165/3.7L (2bbl.)	6916779-UP	1987-89
485 (2bbl.)	5685394-6218036	1980-82
488 (4bbl.)	6170297-6916778	1983-84
190 (4bbl.)	6916779-UP	1985-86
180/3.7LX (4bbl.)	6916779-UP	1987-89

GM INLINE 6 CYLINDER (STERN DRIVE)		
MODEL	S/N	YEAR
140	1538930-1725960	1963
150	1666495-2048046	1964-66
160	2048022-2770031	1967-69
165	2770032-5178958	1970-78
165	5178959-5813433	1979-81
200	2453769-2712072	1969

GM V6 (STERN DRIVE)		
MODEL	S/N	YEAR
185 (4bbl.)	6330183-6919655	1983-84
185 (2bbl.)	A331455-B527954	1985-87
175/4.3L (2bbl.)	B527955-D714106	1987-92
4.3L (GEN II)(2bbl.)	D714107-F000877	1992-93
4.3L (GEN II)(2bbl.)	F000878-F601126	1993-95
4.3L (GEN II)(2bbl.)	F601127-F000878	1996
4.3LX (GEN+)(2bbl.)	F803000-K999999	1996-97
4.3L (GEN+)(2bbl.)	L010044-UP	1998-UP
4.3L EFI (GEN+)(TBI)	L012009-UP	1998-UP
205 (4bbl.)	A331455-B527954	1985-87
205/4.3LX (4bbl.)	B527955-D714369	1987-91
4.3LX (GEN II)(4bbl.)	D714370-F001219	1992-93
4.3LX (GEN II)(4bbl.)	F001220-F601126	1993-95
4.3LX (GEN II)(4bbl.)	F601127-F802999	1996
4.3LXH (GEN+)(4bbl.)	F803114-UP	1996-97
4.3LH(GEN+)(4bbl.)	L010044-UP	1998
262 Mag. (TBI)(GEN+)	F803800-K999999	1996-97

FORD V8 (STERN DRIVE)		
MODEL	S/N	YEAR
888 (2bbl.)	3108723-4887829	1971-77
215 (4bbl.)	2781153-3385720	1970-72
225 (4bbl.)	3385721-4166999	1973-74

FORD V8 (STERN DRIVE) Cont.		
MODEL	S/N	YEAR
225-S (4bbl.)	3385721-4166999	1973-74
233	4173000-4902304	1975-77
255	3258728-4175499	1971-74

GM V8 283, 327, 305 & 350 CID		
MODEL	S/N	YEAR
190	1564539-1730903	1963-64
898 (2bbl.)	4762210-6218461	1977-82
898 (2bbl.)	6218462-B525981	1983-84
200/5.0L (2bbl.)	6218462-F600999	1985-95
5.0L (2bbl.)	L015751-UP	1998-UP
5.0L EFI	L012052-L340000	1998-99
228 (4bbl.)	4765100-5170008	1977-78
228 (4bbl.)	5170009-6218461	1979-82
228 (4bbl.)	6218462-B525981	1982-84
230 (4bbl.)	6218462-B525981	1985-86
230/5.0LX (4bbl.)	B525982-F600999	1987-95
225	1539620-2694014	1963-69
250	2314301-2639854	1968-69
255	4175500-4767999	1975-76
250	4768000-4908849	1977
260/5.7L	4908850-6218461	1978-82
260/5.7L	621462-B525981	1982-86
260/5.7L	B525982-F600999	1987-95
5.7L (2bbl.)	F601000-UP	1996-98
5.7L EFI	F225560-UP	1995-UP
5.7LX (4bbl.)	F601000-K999999	1996-97
5.7LX EFI	F752400-K999999	1996-97
5.7LX Bravo EFI	F800300-K999999	1996-97
350 Mag. Alpha	A635178-B525981	1986-87
350 Mag. Alpha	B525982-F600999	1987-95
350 Mag. Alpha	F601000-K001526	1996
350 Mag. Alpha	K001527-K999999	1997
350 Mag. Alpha EFI	F800300-K999999	1996-97
350 Mag. Bravo MPI	F415189-K999999	1995-97
350 Mag. Bravo MPI (GEN +)	F602000-K999999	1996-97
350 Mag. MPI (GEN+)	L010019-UP	1998-UP
270	2851074-3385720	1969-72
280TRS	4176250-4770199	1975-76
300 Tempest	6668677-B430367	1985-86
320 (EFI)	A543604-C622418	1987-89

GM V8 427, 454, 502, 540 & 572 (STERN DRIVE)		
MODEL	S/N	YEAR
325	2278747-3780449	1969-72
330	4623115-6083144	1977-81
330	6083145-B816450	1982-87
7.4L Bravo	B771113-D603117	1988-91
7.4L Bravo (Gen.V)	D603118-F800699	1992-96
7.4L Bravo (Gen.VI)	F800700-K999999	1996-97
7.4LX Bravo (MPI)(Gen.V)	F602010-F801999	1996
7.4LX Bravo (MPI)(Gen.VI)	F802000-K999999	1996-97
7.4L MPI (Gen.VI)	L010003-UP	1998
7.4LX Bravo (TBI)(Gen.VI)	F820000-K999999	1996-97
454 Mag. Alpha	A631894-UP	1986-88
454 Mag. Bravo (Gen.V)	D805069-F304999	1992-94
454 Mag. Bravo (Gen.V)	F305000-F801699	1995-96
454 Mag. Bravo (Gen.VI)	F801700-K999999	1996-97
454 EFI (Gen.V)	F115700-F802349	1994-96
454 Mag. MPI (Gen.VI)	F802350-K999999	1996-97
454 Mag. MPI (Gen.VI)	L010029-L085399	1998
454 Mag. MPI (Gen.VI)	L085400-UP	1999-UP
370 TRS	4179554-6721527	1978-85
370 TRS	6721528-B714586	1985-87
400 TRS	4179554-B457644	1980-86
420	A398941-D937011	1987-89
425	A398941-D937011	1990-93
440 TRS	4179554-B485220	1983-86
450 (Gen.V)	F347100-F347277	1995-96
525 SC	D456000-F348963	1991-92
525 SC (Gen.V)	D456000-F348963	1992-95
525 SC (Gen.V)	F615814-F745215	1996
525 SC (Gen.VI)	F745260-UP	1996-97
390	2781129-3042731	1969-70
460 TRS	4719554-6181046	1983-86
465	C849992-F213244	1990-92
465 (Gen.V)	C849992-F213244	1992-94
500 (Gen.V)	F213293-F745159	1994-96

GM V8 427, 454, 502, 540 & 572 (STERN DRIVE) Cont.		
MODEL	S/N	YEAR
500 (Gen.VI)	F745195-L001772	1997-98
502 Mag. Bravo	C878221-D824588	1990-92
502 Mag. Bravo (Gen.V)	D824589-F114528	1992-93
502 EFI (Gen.V)	D840650-F802599	1993-96
502 Mag.MPI (Gen.VI)	F802600-K999999	1996-97
500 EFI	L001477-UP	1999-UP
502 Mag.MPI (Gen.VI)	L085433-UP	1998
600 SC	D456489-F877642	1991-92
600 SC (Gen.V)	D456489-F877642	1992-96
600 SC (Gen.VI)	K000227-UP	1997
500 Bulldog	C577254-F745405	1990-96
500 Bulldog	K000248-UP	1997
575	A677429-D763716	1986-92
800 SC (Gen.V)	D763836-UP	1993-96

MCM 4,5,6 & V8 CYLINDER DIESEL STERN DRIVE ENGINE			
MODEL	HP	S/N	YEAR
Rover	60	3140000F-UP	1965-67
530 D-TA	150	B993000-B993492	1989
636 D-TA	180	B993500-C696047	1989
D183	140	B993493-D725149	1990-93
D219	170	C696048-D850124	1990-93
D254	200	C849484-D554729	1990-93
D3.0L	140	D725150-UP	1994-UP
D3.6L	170	D850125-UP	1994-UP
D4.2L	200	D554730-UP	1994-UP
D7.3L	238	F060000-UP	1994-UP

MERCURY MARINE MIE 4 CYLINDER (INBOARD)		
MODEL	S/N	YEAR
470	5520115-6218036	1980-81

FORD MIE V8 (INBOARD)		
MODEL	S/N	YEAR
215	2781153-3563181	1970-72
225	3385721-4176999	1970-72
233	4173000-4775784	1975-76
255	3258728-4178299	1973-74

GM MIE V8 305,327,350 CID (INBOARD)		
MODEL	S/N	YEAR
198	4762210-6218461	1977
228	4765100-5170008	1977-78
228	5170009-5907057	1979-80
230/5.0L (4bbl.)	5907058-B788151	1981-87
225	2278647-2694014	1968
250	2314301-2639854	1968-69
255	4175500-5907057	1975-80
260/5.7L	5907058-F024999	1981-93
270	2851074-3077735	1969-72
5.7L	F025000-K999999	1994-97
5.7L (Gen+)	L002003-UP	1998
5.7L MPI	K040300-K999999	1997
350 Mag. MPI (Gen+)	L002008-L304499	1998
350 Mag. MPI (Gen+)	L304500-UP	1999
350 Horizon	L304700-UP	1999-UP
5.7L Ski	A338533-B514626	1985-87
5.7L Competition Ski	B514627-F775199	1987-95
5.7L Competition Ski	F775200-K040003	1996
5.7L Competition Ski	K040004-K999999	1997
5.7L Competition Ski (Gen+)	L002005-UP	1998-UP
350 Mag. Ski	D505450-K999999	1991-97
350 Mag. EFI Ski	F215561-K999999	1994-97
350 Mag. MPI Ski	F350583-F799999	1995-98
Black Scorpion Ski	F800000-UP	1996-98

GM MIE V8 427, 454, 482 & 502 CID (INBOARD)		
MODEL	S/N	YEAR
325	2278747-3780449	1968-74
330	4623115-5889913	1977-80
340/7.4L w/B/W MK4	5889914-UP	1981-92
7.4L w/Hurth (LH) MK4	C391564-D715493	1989-92
7.4L (LH)	D715494-K999999	1992-97
7.4L MPI (LH)	F563052-K999999	1995-97
7.4L MPI (L29) Gen VI	L002006-UP	1998
7.4L TBI (LH) Gen VI	F874815-K999999	1996-97
454 Mag. MPI Horizon	L002200-L086049	1998-99
454 EFI (SKI) (Gen.V)	F215800-F820099	1995-96
454 Mag. MPI (SKI)(Gen.VI)	F820100-K999999	1996-97
350	9780450-4623109	1974-76
390	2781129-2825059	1969-70
8.2L w/ Hurth	C878221-D857199	1990-92
8.2L (Gen.V)	D857200-F819619	1993-96
8.2L MPI (LH) Gen VI	F819620-K999999	1996-97

GM MIE V8 427, 454, 482 & 502 CID (INBOARD)		
MODEL	S/N	YEAR
8.2L MPI (LH) Gen VI	L002450-L0086012	1998
8.2L MPI (LH) Gen VI	L0086013-UP	1999

MIE 5, 6 & V8 CYLINDER DIESEL INBOARD ENGINES			
MODEL	HP	S/N	YEAR
530 D-TA	150	B993002-C539258	1989
636 D-TA	180	B993750-C696011	1989
D183	150	C539259-D725149	1990-93
D219	180	C696012-D850124	1990-93
D254	210	C849461-D554729	1990-93
D3.0L	150	D725150-UP	1994-UP
D3.6L	180	D850125-UP	1994-UP
D4.2L	210	D554730-UP	1994-UP
D7.3L	262	F060000-UP	1994-UP

MC 60, 80 & 90 STERN DRIVES & TRANSOM PLATES		
MODEL	S/N	YEAR
60 (O)	1830753-2063740	1965-66
80	2063741-2898029	1966-69
90	2898020-3225967	1970-72

MC I, II & III		
MODEL	S/N	YEAR
I	1534570-1684187	1963
II (1.33:1)	1474909-2278488	1962-67

MC I, II & III Cont.		
MODEL	S/N	YEAR
II (1.78:1)	2398798-2671321	1968-69
III	2373127-3002613	1968-72
III	5128065-UP	1978-UP

MC 1A, 1B & 1C		
MODEL	S/N	YEAR
1A, 1B & 1C	1684188-1777798	1964
1A, 1B & 1C (E-Z Shift)	1776349-2065189	1965-66

MC 120, 140, 160 & 165		
MODEL	S/N	YEAR
120/140	2062141-378049	1967-73
120/140	3780850-4893634	1974-77
120/140	4893635-6225576	1978-82
160	2065190-2763441	1967-69
165	2763442-3780849	1970-73
165	3780849-4890459	1974-77
165	4890460-6268064	1978-82

MC470 & 485		
MODEL	S/N	YEAR
470	4208730-4893834	1976-77
470	4893835-6225576	1978-82
485	5487437-6225576	1980-82

MC 888, 225S & 233		
MODEL	S/N	YEAR
888	3106717-3784374	1971-73
888	3784375-4782329	1974-77
225S	3856268-4200499	1974
233	4200500-4782329	1975-77

MC 898, 228, 250 & 260		
MODEL	S/N	YEAR
898/228	4782330-4898729	1977
898/228	4898730-6229157	1978-82
250	4791300-4898729	1977
260	4898730-6229157	1978-82

MC R, MR, ALPHA ONE, ALPHA ONE SS & ALPHA ONE GEN II		
MODEL	S/N	YEAR
R	6152230-6847029	1983-84
MR	6810538-A479506	1985
Alpha One	A470165-UP	1986-90
Alpha One SS	A545004-UP	1986-89
Alpha One Gen II	D469859-UP	1991-UP

MC BRAVO & BLACKHAWK		
MODEL	S/N	YEAR
Bravo One	B664190-UP	1988-UP
Bravo Two	C564952-UP	1989-UP
Bravo Three	D763691-UP	1993-UP
Blackhawk	F186717-UP	1994-UP

MC 215E & 215H		
MODEL	S/N	YEAR
215H	2782203-2909034	1970
215E	2782203-2909034	1970-72

MC TR & TRS		
MODEL	S/N	YEAR
TR	3377316-3787239	1973
TR	3787240-4794899	1974-76
TR	4794900-5009866	1977
TR	5009867-UP	1978-UP
TRS	3787240-4203749	1974-75
TRS	4203750-4795399	1976
TRS	4795400-UP	1977-UP



**18-5291**  
**TUNE-UP KIT**  
 Replaces: 808483K2  
 GM V-8 engines w/Delco HEI-1998 and newer  
 (except MPI engines with 555 ECM)



**18-5246**  
**TUNE-UP KIT**  
 Replaces: 898253T28  
 For: Late model V-6, 4.3L (Alpha/Bravo)



**18-5247**  
**TUNE-UP KIT**  
 Replaces: 898253T29  
 For: Late model V-8 (Alpha/Bravo 350  
 Mag, 5.0L, & MX 6.2L)

① **18-5250D** Display Package



**18-5250**  
**TUNE-UP KIT**  
 Replaces: 34235T1, 34235Q1

—CONTAINS—		
Part #	O.E. #	Description
18-5311	34235	Contact Set
18-5345	33662	Condenser
18-5418	58217	Rotor

Delco 4 & 6 cyl.

① **18-5251D** Display Package



**18-5251**  
**TUNE-UP KIT**

—CONTAINS—		
Part #	O.E. #	Description
18-5314	391-5090	Contact Set
18-5338	391-5092	Condenser
18-5404-1	391-7057	Rotor

Mallory 8 cyl. Tall Cap



**18-5252**  
**TUNE-UP KIT**

—CONTAINS—		
Part #	O.E. #	Description
18-5310	33700	Contact Set
18-5344	33706	Condenser

Delco 8 cyl.



**18-5253**  
**TUNE-UP KIT**

—CONTAINS—		
Part #	O.E. #	Description
18-5318	58033	Contact Set
18-5346	58034, 81-64851	Condenser
18-5420	65864	Rotor

Autolite 8 cyl.

① **18-5254D** Display Package



**18-5254**  
**TUNE-UP KIT**

—CONTAINS—		
Part #	O.E. #	Description
18-5317	64850, 87-71831	Contact Set
18-5346	58034, 81-64851	Condenser
18-5420	65864, 78016	Rotor

Mercury 8 cyl.

① **18-5258D** Display Package



**18-5258**  
**TUNE-UP KIT**

—CONTAINS—		
Part #	O.E. #	Description
18-5303	392-6325	Contact Set
18-5347	392-6324	Condenser
18-5407	392-6326	Rotor

Prestolite 8 cyl.

① **18-5260D** Display Package



**18-5260**  
**TUNE-UP KIT**

—CONTAINS—		
Part #	O.E. #	Description
18-5303	392-6325	Contact Set
18-5345	392-6324	Condenser
18-5403	392-9767	Rotor

Prestolite 8 cyl.



**18-5266**  
**TUNE UP KIT**  
 Fits: Flame Thrower Distributors 18-5481, 18-5482,  
 18-5483, 18-5477, 18-5478 and 18-5479



**18-5267**  
**TUNE-UP KIT**

—CONTAINS—		
Part #	O.E. #	Description
18-5318	58033	Contact Set
18-5346	58034, 81-64851	Condenser
18-5420	65864, 78016	Rotor
18-5389	393-4988T	Distributor Cap

Autolite V-8 - Single Point



**18-5268**  
**TUNE-UP KIT**

—CONTAINS—		
Part #	O.E. #	Description
18-5311	34235	Contact Set
18-5345	33662	Condenser
18-5418	58217	Rotor
18-5385	393-9459	Distributor Cap

Delco In-Line 4 - Single Point



**18-5269**  
**TUNE-UP KIT**

—CONTAINS—		
Part #	O.E. #	Description
18-5311	34235	Contact Set
18-5345	33662	Condenser
18-5418	58217	Rotor
18-5386	33765	Distributor Cap

Delco In-Line 6 - Single Point



**18-5270**  
**TUNE-UP KIT**

—CONTAINS—		
Part #	O.E. #	Description
18-5310	33700	Contact Set
18-5344	33706	Condenser
18-5384	33708	Distributor Cap

Delco V-8 - Single Point

① Items ending in "D" are Display Packaged - Regular number is Non-Display



**18-5271  
TUNE-UP KIT**

—CONTAINS—

Part #	O.E. #	Description
18-5314	391-5090	Contact Set
18-5338	391-5092	Condenser
18-5404-1	391-7057, 391-5088	Rotor
18-5376	391-5075	Distributor Cap

Mallory V-8 - Single Point - Top Terminal

Display Package



**18-5273  
TUNE-UP KIT**

—CONTAINS—

Replaces: 805759T3 / 805759Q3

Part #	O.E. #	Description
18-5431	13524A5	Rotor
18-5395	16457A4	Distributor Cap

Mercury Thunderbolt HEI - V-8

Display Package



**18-5274  
TUNE-UP KIT**

—CONTAINS—

Part #	O.E. #	Description
18-5432	13524A6	Rotor
18-5396	13753A2, 815407A2	Distributor Cap

Mercury Thunderbolt HEI - V-6

Display Package



**18-5275  
TUNE-UP KIT**

—CONTAINS—

Part #	O.E. #	Description
18-5303	392-6325	Contact Set
18-5347	392-6324	Condenser
18-5403	392-9089	Rotor
18-5352	392-9766	Distributor Cap

Prestolite V-8 - Single Point - Screw Cap

Display Package



**18-5276  
TUNE-UP KIT**

—CONTAINS—

Part #	O.E. #	Description
18-5303	392-6325	Contact Set
18-5347	392-6324	Condenser
18-5403	392-9089	Rotor
18-5353	392-9086	Distributor Cap

Prestolite V-6 - Single Point - Screw Cap

Display Package



**18-5277  
TUNE-UP KIT**

—CONTAINS—

Part #	O.E. #	Description
18-5303	392-6325	Contact Set
18-5347	392-6324	Condenser
18-5407	392-6326	Rotor
18-5369	392-6318	Distributor Cap

Prestolite V-8 - Single Point - Clip Cap

Display Package



**18-5278  
TUNE-UP KIT**

Replaces: 850484T3  
Delco EST - V-6

Display Package



**18-5280  
TUNE-UP KIT**

Replaces: 811635Q2  
Delco EST - In-Line 4

—CONTAINS—

Part #	Description	O.E. #	Qty.
18-5361	Distributor Cap	811635, T3	1
18-5406	Rotor	811636, 1	1

Display Package



**18-5281  
TUNE-UP KIT**

Replaces: 808483Q2  
Delco EST - V-8

—CONTAINS—

Part #	Description	O.E. #	Qty.
18-5354	Distributor Cap	808483	1

Display Package



**18-5282  
TUNE-UP KIT**

Holley, Mercury Marine -  
Single Point V-8

Display Package



**18-5283  
TUNE-UP KIT**

For: Mallory Single Point In-Line 4

Display Package



**18-5301  
TUNE-UP KIT**

Replaces:  
Fits: male cap v-8 flamethrower distributors

NEW

Display Package



**18-5302  
TUNE-UP KIT**

Replaces:  
Fits: male cap v-8 flamethrower distributors

NEW

Display Package



**18-5303  
CONTACT SET**

Replaces: 392-898253005

Display Package



**18-5310  
CONTACT SET**

Replaces: 33700

Display Package



**18-5311  
CONTACT SET**

Replaces: 34235, 34235T

Display Package



**18-5314  
CONTACT SET**

Replaces: 391-5090,  
391-898253004

Display Package

 <p><b>18-5317 CONTACT SET</b> Replaces: 64850, 87-71831</p>	 <p><b>18-5318 CONTACT SET</b> Replaces: 58033, 898253007</p>	 <p><b>18-5338 CONDENSER</b> Replaces: 391-5092, 391-898253001</p>	 <p><b>18-5344 CONDENSER</b> Replaces: 33706</p>	 <p><b>18-5345 CONDENSER</b> Replaces: 33662, 898253003</p>
 <p><b>18-5346 CONDENSER</b> Replaces: 58034, 81-64851</p>	 <p><b>18-5347 CONDENSER</b> Replaces: 392-6324, 392-898253002</p>	 <p><b>18-5402 ROTOR</b> Replaces: 898253009 GM V-8 engines w/Delco HEI- 1998 and newer (except MPI engines with 555 ECM)</p>	 <p><b>18-5245 ROTOR</b> Replaces: 884790, 898253013 For: Late model V-6, V-8 (Alpha/ Bravo 350 Mag, 5.0L, &amp; MX 6.2L)</p>	 <p><b>18-5403 ROTOR</b> Replaces: 392-9089, 392-9089T, 392-9767</p>
 <p><b>18-5404-1 ROTOR</b> Replaces: 391-7057, 391-5088, 391-7057T, 391-898253029</p>	 <p><b>18-5405 ROTOR</b> Replaces: 808484, 808484 1, 898253010 Use with <b>18-5354</b> Distributor Cap Fits new GM style "Module in Cap" distributors - V-8 application</p>	 <p><b>18-5406 ROTOR</b> Replaces: 811636, 811636 1, 898253011 Use with <b>18-5361</b> Distributor Cap 3.0L LX</p>	 <p><b>18-5407 ROTOR</b> Replaces: 392-6326, 392-6326T</p>	 <p><b>18-5300 ROTOR</b> Fits: Flamethrower Distributors</p>
 <p><b>18-5408 ROTOR</b> Replaces: 850485, 850485 1, 898253012 Use with <b>18-5362</b> Distributor Cap Fits new GM Style "Module in Cap" Distributors V6 Applications</p>	 <p><b>18-5418 ROTOR</b> Replaces: 58217, 898253008</p>	 <p><b>18-5420 ROTOR</b> Replaces: 65864, 78016</p>	 <p><b>18-5431 ROTOR ASSEMBLY</b> Replaces: 13524A5, T1 V-8</p>	
 <p><b>18-5432 ROTOR ASSEMBLY</b> Replaces: 13524A6 V-6</p>	 <p><b>18-5243 DISTRIBUTOR CAP</b> Replaces: 888731, 898253T23 For: Late model V-6 (4.3L Alpha/Bravo)</p>	 <p><b>18-5244 DISTRIBUTOR CAP</b> Replaces: 884792, 858253T22 For: Late model V-8 (Alpha/Bravo 350 Mag, 5.0L, &amp; MX 6.2L)</p>	 <p><b>18-5352 DISTRIBUTOR CAP</b> Replaces: 392-9766, Q1</p>	

 <p><b>18-5353 DISTRIBUTOR CAP</b> Replaces: 392-9086, 392-9086T</p>	 <p><b>18-5354 DISTRIBUTOR CAP</b> Replaces: 808483, 808483T3 Fits new GM style "Module in Cap" Distributors-V-8 applications Use <b>18-5405</b> Rotor</p>	 <p><b>18-5361 DISTRIBUTOR CAP</b> Replaces: 811635, 811635T3 Use <b>18-5406</b> Rotor 3.0L LX</p>	 <p><b>18-5362 DISTRIBUTOR CAP</b> Replaces: 850484, 850484T, 850484T2 Fits new GM Style "Module in Cap" Distributors - V6 Applications Use <b>18-5408</b> Rotor</p>
 <p><b>18-5369 DISTRIBUTOR CAP</b> Replaces: 392-6318, 392-6318T with gasket <b>18-5399</b></p>	 <p><b>18-5376 DISTRIBUTOR CAP</b> Replaces: 391-5075, 391-5075Q1</p>	 <p><b>18-5384 DISTRIBUTOR CAP</b> Replaces: 33708</p>	 <p><b>18-5385 DISTRIBUTOR CAP</b> Replaces: 393-9459, 393-9459Q1</p>
 <p><b>18-5386 DISTRIBUTOR CAP</b> Replaces: 33765, 33765T</p>	 <p><b>18-5389 DISTRIBUTOR CAP</b> Replaces: 393-4988T, 393-4988T2</p>	 <p><b>18-5395 DISTRIBUTOR CAP</b> Replaces: 16457A4, 805759T, 805759T1 V-8</p>	 <p><b>18-5396 DISTRIBUTOR CAP</b> Replaces: 13753A2, 815407A2 V-6</p>
 <p><b>18-5397 DISTRIBUTOR CAP</b></p>	 <p><b>18-5473 DISTRIBUTOR CAP</b> Black Distributor Cap w/ Male Terminals Petronix Dsistributors</p>	 <p><b>18-5474 DISTRIBUTOR CAP</b> Red Distributor Cap with Male Terminals Petronix Dsistributors</p>	<p>PKG OF 2</p>  <p><b>18-5399 18-5399-9① DISTRIBUTOR CAP GASKET</b> Replaces: 392-6329</p>

## FEATURES

- Oil filled for better cooling and long life
- Low resistance and improved turn ratios produces the higher voltage needed to run larger spark plug gaps for added power and better fuel economy
- More windings maximize energy and reliability over the full RPM range
- Fits existing brackets for easy installation

 <p><b>18-5466 HI-PERFORMANCE IGNITION COIL</b> 1.5 ohm (oil filled), black - 8 cylinder: Flame-Thrower 40,000 volt coil.</p> <ul style="list-style-type: none"> <li>• Designed for use with the original Ignitor Electronic Conversion Kits</li> <li>• Can be used with other inductive ignition systems</li> </ul>	 <p><b>18-5469 HI-PERFORMANCE IGNITION COIL</b> 3.0 ohm (oil filled), black - 4 &amp; 6 cylinder: Flame-Thrower 40,000 volt coil.</p> <ul style="list-style-type: none"> <li>• Designed for use with the original Ignitor Electronic Conversion Kits</li> <li>• Can be used with other inductive ignition systems</li> </ul>	 <p><b>18-5472 HI-PERFORMANCE IGNITION COIL</b> 0.6 ohm (oil filled), black - 4, 6, &amp; 8 cylinder:Flame-Thrower 45,000 volt coil.</p> <ul style="list-style-type: none"> <li>• Super low 0.6 ohm resistance coil designed for use with the Ignitor II Hi Performance Electronic Conversion Kits</li> <li>• Compatible with capacitive discharge systems</li> </ul>
---	--	--

① Priced per Package

COIL APPLICATION BEGINS ON NEXT PAGE  
CAP APPLICATION BEGINS ON PAGE 593

Part #	Description	Recommended Coil	Resistance Ohms	Part #	Description	Recommended Coil	Resistance Ohms
18-5294	Electronic Conversion Kit	18-5469	3.0	18-5286	Hi Performance Electronic Conversion Kit	18-5472	0.6
18-5295	Electronic Conversion Kit	18-5469	3.0	18-5288	Hi Performance Electronic Conversion Kit	18-5472	0.6
18-5296-2	Electronic Conversion Kit	18-5466	1.5	18-5289	Hi Performance Electronic Conversion Kit	18-5472	0.6
18-5297	Electronic Conversion Kit	18-5469	3.0	18-5290	Hi Performance Electronic Conversion Kit	18-5472	0.6
18-5298	Electronic Conversion Kit	18-5466	1.5	18-5481	Flame-Thrower Distributor	18-5472	0.6
18-5299	Electronic Conversion Kit	18-5466	1.5	18-5482	Flame-Thrower Distributor	18-5472	0.6
18-5285	Hi Performance Electronic Conversion Kit	18-5472	0.6	18-5483	Flame-Thrower Distributor	18-5472	0.6



**18-5433  
IGNITION COIL**  
Replaces: 38547, 32193A2, 392-806529A1, 898253T24 DELCO 1115202  
(Uses External Resistor)

[Display Package](#)



**18-5438  
IGNITION COIL**  
Replaces: 392-7803A4, 392-805570A2 HEI



**18-5465  
IGNITION COIL**  
Replaces: 392-863704T ss 8M0054588 2001 and newer 4.3L, 5.0L, 5.7L & 6.2L with 555 ECM (OM300000 and up)



**18-7493  
COIL**  
Replaces: 392889925  
For: 8.1L & 496 Mag OM315053 & UP



**18-7648  
IGNITION COIL**  
Replaces: 392881732



**18-5442  
IGNITION COIL**  
Replaces: 806673T, T1



**18-5443  
IGNITION COIL**  
Replaces: 817378T, 817378, 898253T27



**18-5117  
IGNITION MODULE**  
Replaces: GM 10482803  
Fits: MCM MIE 4.3L MPI, 5.0L MPI, 350 Mag MPI and MX 6.2L MPI engines with ECM555 (2001 & Up) S/N OM300000 & Up



**18-5107-1  
IGNITION MODULE**  
4/6/8 cyl.  
Replaces: 811637001



**18-5464  
IGNITION MODULE**  
Fits: Sierra 18-5481, 18-5482 and 18-5483 Billet HI-PERFORMANCE ELECTRONIC DISTRIBUTORS (except HEI/EST)



**18-5488  
IGNITION MODULE**  
Replacement module for Mallory electronic distributors



**18-5108  
PICK UP  
COIL SENSOR**  
Replaces: 811639, T V4/V6/V8



**18-5116-1  
IGNITION SENSOR KIT**  
Replaces: 87-861780A2, Q4  
For: V-6 & V-8 with Thunderbolt ignition (1981-1997) nut connectors



**18-7757  
THROTTLE POSITION SENSOR**  
Replaces: 803148  
For: 350 Mag OL005900 & Up



- Senses current levels in the coil and adjusts the dwell to maintain peak energy throughout the entire RPM range.
- Develops, on average, 4 times more available energy between 3000 and 5000 RPM's and twice as much plug voltage as point-type systems.
- Ignition energy is sustained and coil life is increased when peak current level is reached just prior to spark.
- More stable timing.
- Use with 18-5472 "Flame Thrower II" Coil for optimum performance

**18-5285**  
**HI-PERFORMANCE**  
**ELECTRONIC**  
**CONVERSION KIT**

Fits: 4 Cylinder Delco Distributors



**18-5286**  
**HI-PERFORMANCE**  
**ELECTRONIC**  
**CONVERSION KIT**

Fits: 6 Cylinder Delco Distributors



**18-5288**  
**HI-PERFORMANCE**  
**ELECTRONIC CONVERSION KIT**

Fits: Most Prestolite V-8 Distributors with snap down cap



**18-5289**  
**HI-PERFORMANCE**  
**ELECTRONIC CONVERSION KIT**

Fits: Most Prestolite Distributors with screw down cap



**18-5290**  
**HI-PERFORMANCE**  
**ELECTRONIC CONVERSION KIT**

Fits: Most Mallory YL or YD 8 cylinder Distributors with clockwise and counter clockwise rotation



## FEATURES

- Replaces point & condensers for true solid state ignition.
- Uses standard coil, cap and rotor.
- Easy to install, one-piece, 2-wire hook-up.
- Accurate to within 1/4° timing accuracy 0 to 6000 RPM range.
- Can be used with Flame Thrower 18-5466 & 18-5469.

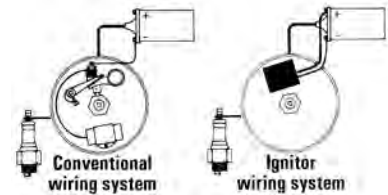

**18-5294**  
**ELECTRONIC CONVERSION KIT**

Fits: 6 Cyl. Delco Distributors



**18-5295**  
**ELECTRONIC CONVERSION KIT**

Fits: Most 4 Cyl. Prestolite Distributors (Except IBM7026)  
For: Onan, Universal, Waukesha, Wisconsin



**18-5296-2**  
**ELECTRONIC CONVERSION KIT**

Fits: Most Mallory YL or YD 8 cyl. Distributors with clockwise or counter clockwise rotation



① **18-5296-2D** Display Package

**18-5297**  
**ELECTRONIC CONVERSION KIT**

For 4 Cyl. GM



① **18-5297D** Display Package

**18-5298**  
**ELECTRONIC CONVERSION KIT**

(with snap down cap) For: Most Prestolite V-8 Distributors



**18-5299**  
**ELECTRONIC CONVERSION KIT**

(with screw down cap) For: Most Prestolite V-8 Distributors  
Use with 18-5403 Style Rotor



① **18-5299D** Display Package

APPLICATION BEGINS ON PAGE 593

① Items ending in "D" are Display Packaged - Regular number is Non-Display



## FEATURES

- Distributors feature the Ignitor II ignition module with adaptive dwell control adjusts the spark timing over the entire RPM range to maximize performance
- Upper roller bearing and oil impregnated bronze sintered bottom bushing are installed and aligned bored for accuracy for maximum durability
- Machined heat treated gear with tight tolerances insures durability and consistent timing to maximize horsepower and performance. Complete with high dielectric strength cap and rotor for years of performance

Standard Rotation

CCW Rotation

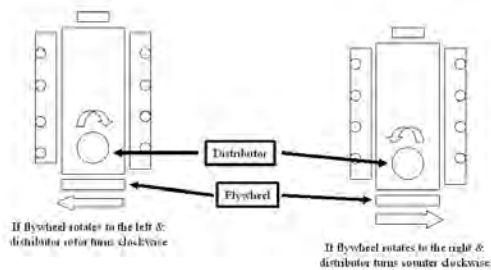

**18-5481**  
**HI-PERFORMANCE**  
**ELECTRONIC DISTRIBUTOR**  
Fits: Ford V-8 351 Windsor  
Replacement cap/rotor kit: 18-5266



**18-5482**  
**HI-PERFORMANCE**  
**ELECTRONIC DISTRIBUTOR**  
Fits: Ford V-8 351 Cleveland, 351M, 400, 429 and 460 engines  
Replacement cap/rotor kit: 18-5266



**18-5483**  
**HI-PERFORMANCE**  
**ELECTRONIC DISTRIBUTOR**  
Fits: Chevrolet marine small and big block engines (standard deck height)  
Replacement cap/rotor kit: 18-5266



**18-5477**  
**ELECTRONIC DISTRIBUTOR**  
Fits: Ford 302 V-8 engines



**18-5478**  
**ELECTRONIC DISTRIBUTOR**  
Fits: Chrysler LA series V-8 engines



**18-5479**  
**ELECTRONIC DISTRIBUTOR**  
Fits: GM V-8 engines-reverse rotation



**18-5480**  
**COMPLETE IGNITION**  
**CONVERSION KIT**  
Fits: GM SB & BB with Standard Deck Height  
—CONTAINS—  
Part # Description  
18-5472 Coil  
18-8803-2 Wire Set  
18-5483 Distributor



**18-5470**  
**THUNDERBOLT IV V-8 DISTRIBUTOR**

Replaces: 805185A36  
Fits: GM V-8 engines



**18-5471**  
**THUNDERBOLT IV V-6 DISTRIBUTOR**

Replaces: 805185A37  
GM V-6 engines



**18-5350**  
**DISTRIBUTOR**

Replaces: 888751A03  
Fits: Vortec™ V-6 4.3L MPI (2002-06)



**18-5351**  
**DISTRIBUTOR**

Replaces: 884794A02  
Fits: Vortec V-8 2001 and up 5.0L/ 5.7L/ 6.2L MPI engines (S/N OM300000 and up)



**18-5475**  
**DISTRIBUTOR**

Replaces: 817377  
FITS: 4 CYL GM W/ DELCO EST IGNITION



**18-5476**  
**DISTRIBUTOR**

Replaces: 807964A1  
Fits: GM V-6 engines with Delco EST ignition HEI



**18-5484-1**  
**ELECTRONIC DISTRIBUTOR**

**Left Hand** Rotation  
Replaces: Mallory YLE624AV  
Late Model HEI

For V8 — 262-454 & 502 except 384/ 409 and tall block engines  
• Designed as a plug-in replacement for GM-style fuel injection system distributors

—CONTAINS—

Part #	Description
18-5354	Distributor Cap
18-5405	Rotor



**18-5485**  
**ELECTRONIC DISTRIBUTOR**

**Right Hand** Rotation  
Replaces: Mallory YLE624BV  
Late Model HEI

For V8 — 262-454 & 502 except 384/ 409 and tall block engines  
• Designed as a plug-in replacement for GM-style fuel injection system distributors

—CONTAINS—

Part #	Description
18-5354	Distributor Cap
18-5405	Rotor



**18-5486**  
**ELECTRONIC DISTRIBUTOR**

Conventional Rotation  
For Chevrolet L4, 153 & 181 CID

—CONTAINS—

Part #	Description
18-5397	Distributor Cap
18-5488	Module
18-5404-1	Rotor



**18-5487**  
**ELECTRONIC DISTRIBUTOR**

Conventional Rotation  
For Chevrolet L6, 194, 230, 250, 292 CID

—CONTAINS—

Part #	Description
18-5488	Module
18-5404-1	Rotor

**18-5489  
ELECTRONIC  
DISTRIBUTOR**

Conventional Rotation  
For Ford V8 351W CID



—CONTAINS—

Part #	Description
18-5376	Distributor Cap
18-5488	Module
18-5404-1	Rotor

**18-5494-1  
ELECTRONIC  
DISTRIBUTOR**

Conventional Rotation  
For Chevrolet all V8 includes 482, 502, 540 CID (Except 348,409 & Tall Deck Big Block)



—CONTAINS—

Part #	Description
18-5376	Distributor Cap
18-5488	Module
18-5404-1	Rotor

**18-5495-1  
ELECTRONIC  
DISTRIBUTOR**

Conventional Rotation  
For Ford V8 302 CID



—CONTAINS—

Part #	Description
18-5376	Distributor Cap
18-5488	Module
18-5404-1	Rotor

**18-5496-1  
ELECTRONIC  
DISTRIBUTOR**

Replaces: YLM567CV  
Conventional Rotation  
For Ford V8 351C — 460 CID



—CONTAINS—

Part #	Description
18-5376	Distributor Cap
18-5488	Module
18-5404-1	Rotor

**18-5497-1  
ELECTRONIC  
DISTRIBUTOR**

Replaces: YLM579AV  
Conventional Rotation  
For Chrysler V8 273,318 (67 & UP) 340, 360 CID "LA" engines



—CONTAINS—

Part #	Description
18-5376	Distributor Cap
18-5488	Module
18-5404-1	Rotor

**18-5498-1  
ELECTRONIC  
DISTRIBUTOR**

Replaces: YLM624BV  
Reverse Rotation  
For Chevrolet all V8 includes 482, 502, 540 CID (Except 348,409 & Tall Deck Big Block)



—CONTAINS—

Part #	Description
18-5376	Distributor Cap
18-5488	Module
18-5404-1	Rotor

**18-5309  
DISTRIBUTOR**

Contact Controlled (Standard Rotation)  
Replaces: Mallory YL512CV  
For most Ford 302 CID V-8 Eng.  
Uses: 18-5251 TUNE-UP KIT



—CONTAINS—

Part #	Description
18-5314	Contact Set
18-5338	Condenser
18-5404-1	Rotor

And 18-5376 CAP

**18-5312  
DISTRIBUTOR**

Replaces: Mallory YL554CV  
For most Ford 351 CID V-8 Eng.  
Uses 18-5251 Tune-Up Kit  
& 18-5376 Cap



**18-5313  
DISTRIBUTOR**

Contact Controlled (Standard Rotation)  
Replaces: 17177A1; Mallory YL624AV  
For most GM V-8 Engs. (small & large blocks) Mallory Tall Cap  
Uses: 18-5251 TUNE-UP KIT



—CONTAINS—

Part #	Description
18-5314	Contact Set
18-5338	Condenser
18-5404-1	Rotor

And 18-5376 CAP

**18-5315  
DISTRIBUTOR**

Contact Controlled (Standard Rotation)  
Replaces: 87581; Mallory YL673AV  
For most GM 4 Cyl. Engs. (120 & 140 HP)  
Uses: 18-5251 TUNE-UP KIT



—CONTAINS—

Part #	Description
18-5314	Contact Set
18-5338	Condenser
18-5404-1	Rotor

And 18-5397 CAP











# PREMIUM MARINE SPARK PLUG WIRE LEADS

**MAGFORCE™**



OE Style boots provide a sealed barrier against heat, dirt and moisture.

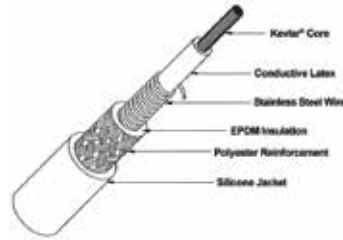

## Premium Marine Wire Leads

### Magnetic Suppression Core

#### Manufactured for your specific application

- Kevlar® core for maximum durability and long life.
- Durable stainless steel wound conductor for maximum horsepower and engine performance.
- Premium silicone jacketing and boots for the ultimate in high temperature protection.
- Superior RFI suppression for the most sensitive electronic system.
- Corrosion resistant stainless steel spark plug and distributor terminals for maximum conductivity.

O.E. #	Cyl.	Part #	O.E. #	Cyl.	Part #
84-816608Q81	8	18-8822-1	84-863656A2	V6	18-8829-1
84-847701A7	8	18-8837-1	84-813720A12, 84-816761Q12	8	18-8802-1
84-813720A2, 84-816608Q61	8	18-8804-1	84-813720A13, 84-816761Q13	4	18-8811-1
84-813720A3, 84-816761Q3	8	18-8804-1	84-816761A4, 84-816761Q4	8	18-8804-1
84-813720A3, 84-816761Q3	8	18-8821-1	84-816761A4, 84-816761Q4	8	18-8821-1
84-813720A4, 84-816761Q4	8	18-8821-1	84-816761A8, 84-816761Q8	L6	18-8809-1
84-813720A4, 84-816761Q4	8	18-8804-1	84-816761A9, 84-816761Q9	8	18-8803-2
84-813720A5, 84-816761Q5	4	18-8800-1	84-816761A17, 84-816761Q17	8	18-8821-1
84-813720A6, 84-816761Q6	4	18-8808-2	84-863656A1	8	18-8828-1
84-816761K14	L4	18-8833-1	84-816608Q80	8	18-8830-1
84-813720A7, 84-816761Q7	V6	18-8801-1	84-816608Q71	8	18-8836-1
84-813720A8, 84-816761Q8	L6	18-8809-1	84-816608K68	8	18-8832-1
84-813720A9, 84-816761Q9	8	18-8803-2	84-816608Q83	8	18-8834-1
84-813720A10, 84-816761Q10	8	18-8803-2	84-881698	8	18-8838-1
84-813720A11, 84-816761Q16	V6	18-8810-1	84-816608K68	8	18-8824-1
84-816608Q82	V6	18-8835-1			

Models	Cyl.	Ignition Type	Part #	Models	Cyl.	Ignition Type	Part #
ALL	4	Digital	18-8811-1	370	8	Conventional	18-8803-2
120 (153 CID)	4	Conventional	18-8800-1	400	8	Conventional	18-8803-2
140 (181 CID)	4	Conventional	18-8800-1	420	8	Thunderbolt	18-8804-1
150	L6	Conventional	18-8809-1	420	8	Thunderbolt	18-8837-1
160	L6	Conventional	18-8809-1	425	8	Thunderbolt	18-8837-1
165	L6	Conventional	18-8809-1	440	8	Conventional	18-8803-2
185 CID	V6	Conventional	18-8801-1	454 CID	8	Thunderbolt	18-8804-1
198 GM	8	Conventional	18-8803-2	454 MAG	8	Thunderbolt	18-8804-1
224 CID	4	Conventional	18-8808-2	454 EFI, Mag MPI and Horizin MIE	8	Delco HEI	18-8832-1
225 FORD	8	Conventional	18-8803-2	454 Hi Perf	8	Thunderbolt	18-8824-1
225 GM	8	Conventional	18-8803-2	460	8	Conventional	18-8803-2
228 GM	8	Conventional	18-8803-2	465	8	Thunderbolt	18-8837-1
229 CID	V6	Conventional	18-8801-1	496	8	Distributorless	18-8838-1
233 FORD	8	Conventional	18-8803-2	500	8	Thunderbolt	18-8837-1
250 GM	8	Conventional	18-8803-2	500 Bulldog	8	Thunderbolt	18-8837-1
255 FORD	8	Conventional	18-8803-2	502 Mag	8	Delco HEI	18-8832-1
260 GM	8	Conventional	18-8803-2	502 EFI & Mag MPI	8	Delco HEI	18-8832-1
260 TR	8	Thunderbolt	18-8804-1	525SC	8	Thunderbolt	18-8837-1
262 CID	V6	Thunderbolt	18-8810-1	600SC	8	Thunderbolt	18-8837-1
280 GM	8	Conventional	18-8803-2	800SC	8	Thunderbolt	18-8837-1
305 CID LH	8	Thunderbolt	18-8804-1	888 FORD	8	Conventional	18-8803-2
305 CID RH	8	Thunderbolt	18-8804-1	898 GM	8	Conventional	18-8803-2
320 EFI	8	Thunderbolt	18-8804-1	2.5L	4	Conventional	18-8800-1
330	8	Conventional	18-8803-2	3.0L	4	Conventional	18-8800-1
330 TR	8	Thunderbolt	18-8804-1	3.0LX	4	Delco EST	18-8833-1
350 CID LH	8	Thunderbolt	18-8804-1	3.7L	4	Conventional	18-8808-2
350 CID RH	8	Thunderbolt	18-8804-1	3.7XL	4	Conventional	18-8808-2
350 MAG	8	Thunderbolt	18-8804-1	4.3L	V6	Thunderbolt	18-8810-1
350 MAG SKI	8	Thunderbolt	18-8821-1	4.3XL	V6	Thunderbolt	18-8810-1
350 MAG BRAVO MPI & GEN +	8	Delco HEI	18-8836-1	4.3L EFI(TBI)	V6	Thunderbolt	18-8810-1
350 MAG MPI MIE (GEN +)	8	Delco HEI	18-8832-1	4.3L MPI	V6	Delco HEI	18-8835-1
350 MAG MPI MIE (GEN +)	8	Mercury HEI	18-8834-1	5.0L	8	Thunderbolt	18-8804-1
350 MAG EFI SKI	8	Delco HEI	18-8832-1	5.0L IB	8	Thunderbolt	18-8804-1
350 MAG MPI SKI (GEN +)	8	Delco HEI	18-8836-1	5.0LX	8	Thunderbolt	18-8804-1
BLACK SCORPION SKI (GEN+) 350CID	8	Delco HEI	18-8832-1	5.0L Alpha & Bravo (Gen+)	8	Thunderbolt	18-8821-1
BLACK SCORPION SKI (GEN+) 350CID	8	Delco HEI	18-8822-1	5.0L MIE MPI	8	Delco HEI	18-8828-1
MX 6.2 BLACK SCORPION SKI	8	Delco HEI	18-8822-1	5.7L	8	Thunderbolt	18-8804-1
				5.7L IB	8	Thunderbolt	18-8804-1
				5.7L SKI	8	Conventional	18-8802-1
				7.4L	8	Thunderbolt	18-8804-1
				7.4L IB	8	Thunderbolt	18-8804-1

I/O — MERCURUISER - Ignition System



**18-5225  
SPARK PLUG WIRE KIT**

Replaces:  
Mercury 84-99215A26,  
84-813706A26  
Kit includes 25 ft. roll of 7 MM hypalon ignition wire with a metallic core and a large assortment of three different end fittings.



**BATTERY CABLES**

Part No.	Size	Color	Gauge	Part No.	Size	Color	Gauge
BC88523	2'	red	4	BC88573	6'	black	2
BC88533	2'	black	4	BC88583	8'	red	1
BC88543	4'	red	2	BC88593	8'	black	1
BC88553	4'	black	2				

BC88563 gauge cable with 5000 series lug terminals on each end to accept a 3/8" stud



**18-5226  
IGNITION WIRE**  
Metallic Core  
100' Spool  
7mm Hypalon

PKG. OF 10



**18-5224  
18-5224-9①  
SPARK PLUG WIRE  
TERMINAL**  
Replaces: Mercury 20121

PKG. OF 10



**18-5750  
18-5750-9①  
UNIVERSAL SPARK  
PLUG BOOTS**  
Supplied complete w/Terminal Connector



**18-5752  
UNIVERSAL  
SPARK PLUG BOOT**  
8mm

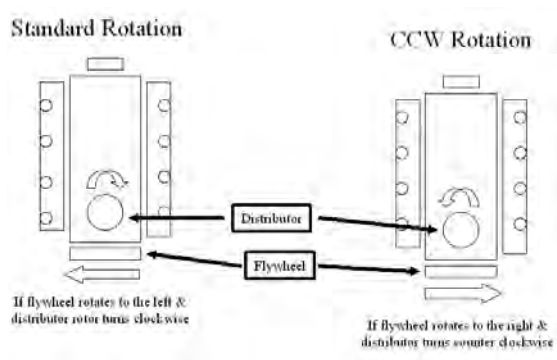

**18-6275  
STARTER**  
Replaces:  
50-807904A1, 50-863007A1  
• Permanent Magnet Gear Reduction Starter  
• Inboard  
• 2 Long Bolt Offset Pattern  
• CW Rotation • SAE J1171  
• Use w/ Late Model 3.0L Engines with 14" Flywheel  
Fits : Volvo Penta, Mercruiser, Marine Power



**18-5603  
STARTER**  
Replaces: 50-808011A4  
Noseless:CCW Top mount rear entry starter for standard rotation GM & Ford engines. Can be used in place of 18-5908 and 18-5902



**18-5923  
STARTER**  
PMGR Replacement for 18-5903;  
302CID, 351CID Ford Engines



**18-5911  
STARTER**  
**(Heavy-Duty) (No Core) (Clockwise) For GM engines, bottom mount straight across bolt pattern. Standard rotation**  
Replaces: 50-76965A4,50-99417A2,50-99419A3, 50-17251A3, 50-77328A3  
Replacement Solenoid: 18-5837  
SAEJ1171



**18-5900  
REMANUFACTURED STARTER**

① Priced per Package



**18-5907  
STARTER**  
(Heavy-Duty) (No Core) (Clockwise) Top mount rear entry starter for opposite rotation GM & Ford engines.  
Will also replace standard rotation. Will not replace non-starter mounted solenoids.  
Mercuriser built 4 cyl. 165/170/180/190/470/485/488  
Replaces: 50-72550A2, 50-79604A3, 50-97499A2, R4, 50-72550R2, 50-97499R3  
Replacement Solenoid: 18-5837  
SAEJ1171



**18-5901  
REMANUFACTURED STARTER**



**18-5913  
STARTER**  
(Clockwise)  
Delco permanent magnet gear reduction 2 bolt starter  
12V - 11 Tooth - Offset Bolt Pattern  
For: Late model GM - 14" Flywheel  
Replaces: 50-812428A3, 50-812604A2,  
50-822330A2, 50-864340A2  
Replacement Solenoid: 18-6287  
SAEJ1171 FOR: 4.3L (1996 & UP); 5.0 & 5.7L (1998 & UP)



**18-5919  
STARTER**  
Permanent magnet I/O starter, 11 Tooth  
Replaces: 50-806963A4, 50-806965A2, 50-806965A4  
Replacement Solenoid: 18-6287  
Fits: Chevy Engines with 12 3/4" flywheels  
Straight across bolt pattern  
SN-OF803000AN/OF803114AN 4.3LX/LXH Alpha/Bravo 262 CID  
SN-355305AN/22560AN 5.7L Alpha (EFI)/5.7L Bravo (EFI)  
SAEJ1171



**18-5910  
STARTER**  
(Heavy-Duty) (No Core) (Clockwise) Small block V-6 & V-8 GM engine with 14 1/4" flywheel and bottom mount, offset bolt pattern. For standard rotation engines.  
Replaces: 50-12177A2, 50-99418A2



**18-5905  
REMANUFACTURED STARTER**



**18-5908  
STARTER**  
(Heavy-Duty) (No Core) (Counter-Clockwise)  
Top mount rear entry starter for standard rotation GM & Ford engines.  
Replaces: 50-76965A3, 50-808011A1  
Replacement Solenoid: 18-5837  
SAEJ1171



**18-5902  
REMANUFACTURED STARTER**



**NEW**



**18-6824  
STARTER**  
Replaces: 50-60594A, A1, T01  
Fits: 2.0, 2.4, and 2.5L Racing Engines

**NEW**



**18-6834  
STARTER**  
Replaces: GM Engines Universal  
Used on Buick, Chevrolet, Oldsmobile, and Pontiac Race Engines

**NEW**



**18-6835  
STARTER**  
Replaces: GM Engines Universal  
Used on Buick, Chevrolet, Oldsmobile, and Pontiac Race Engines

**NEW**



**18-6870  
STARTER**  
Replaces: Mercury 50-805833, T  
Fits: D7.3L D-tronic 260 LD, 300 1999 year

**NEW**



**18-6946  
STARTER**  
Replaces: 50-8m8021116

**NEW**



**18-6947  
STARTER**  
Replaces: Mercruiser 50-805991  
Fits: 7.3L (BRAVO & MIE) DIESEL NAV 444 V-8 1994-1996

**NEW**



**18-6949  
STARTER**  
Replaces: Mercruiser 50-831001562, 50-831001961  
Fits: WO4CTA (150 HP) HINO 234 I/L4, WO4CTI (210 HP) HINO 234 I/L4

**NEW**



**18-6957  
STARTER**  
Replaces: Mercruiser 50-801333980, 50-854178, 50-855507



**18-5903  
STARTER**  
(No Core) (Clockwise) Bottom mount, two bolt pattern for standard rotation Ford engines.  
Replaces: 50-69865A1, 50-12872, 50-56886  
Replacement Solenoid: 18-5801  
\*For PMGR style order 18-5923



**18-2434  
FLYWHEEL BELL HOUSING**  
Replaces: 814309A1  
For: GM V-8's Big & Small Blocks Inboard/Ski Models

**STARTER BOLTS**



Description	Mer cruiser #	Part #
Starter Bolt 3/8 - 16 - 4 3/8 Long	10-8053432	<b>18-8402</b>
Starter Bolt 3/8 - 16 - 1 13/16 Long	10-8053433	<b>18-8403</b>
Starter Bolt 3/8 - 16 - 1 11/16 Long	10-8083434	<b>18-8404-1</b>



**18-5717  
STARTER  
BRUSH SET**  
Replaces: 33270



**18-5804  
SOLENOID**  
Replaces: 13037  
Delco



**18-5837  
SOLENOID**  
Replaces: 89-99253, 89-18080  
Delco



**18-5838  
SOLENOID**  
Replaces: 33261, 89902  
Delco



**18-5840  
SOLENOID**  
Prestolite 15-79,  
SAW 4201, SAW4207, SAW4210

**BRUSH SET/STARTER SWITCH APPLICATION**

Years	Volt.	Starter No.	Brush Set	Starter Switch	Years	Volt.	Starter No.	Brush Set	Starter Switch
1977-82	12	1108755	18-5717	18-5838	1971-78	12	ALL	18-5717	18-5838
1977-82	12	1108756	18-5717	—	1969-78	12	MEO-7003	—	18-5840
1977-82	12	1109484,5,6	18-5717	18-5838					



**18-5801  
SOLENOID**  
Replaces: 89-76416A1

① **18-5801D** Display Package

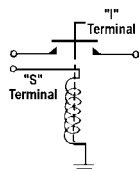

**18-5802  
SOLENOID**  
Replaces: 65057A1, 65057T1

① **18-5802D** Display Package

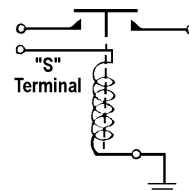

① Items ending in "D" are Display Packaged - Regular number is Non-Display  
**APPLICATION BEGINS ON PAGE 605**

① 18-5810D 



**18-5810 SOLENOID**



**18-5811 STARTER SOLENOID**  
Replaces: 809463A1  
For: PG 260 Series Starters, GM V6 & V8 (1983-Up)

① 18-5815D 



**18-5815 SOLENOID**  
Replaces: 89-68258A4, 89-853654A1, 89-76545

① 18-5816D 

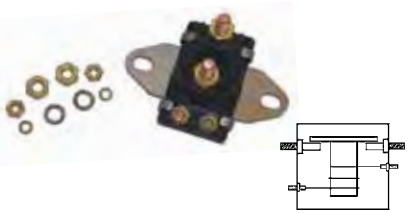

**18-5816 SOLENOID**  
Replaces: 89-96054, T, 89-91975  
(Flat Bracket)

① 18-5817D 



**18-5817 SOLENOID**  
Replaces: 89-96158, T  
(Curved Bracket)



**18-5820 SOLENOID**  
Replaces: 89-818999A2, 89-825842A1, 89-850188T1

① 18-5836D 



**18-5836 SOLENOID**  
Replaces: 25661, 25661 1



**18-9802 TIMING LIGHT**  
*Self-powered accurate up to 10,000 RPM's*



**18-6749 TRIM BRACKET**  
**Metal Bracket**  
Replaces: 862548A1, 42419A1  
For: MerCruiser Floor Mount Bracket



**18-6750 TRIM BRACKET**  
**Stainless Steel**  
Replaces: 862548A1, 42419A1  
For: MerCruiser Floor Mount Bracket



**18-6752 HYDRAULIC TRIM PUMP ASSEMBLY**  
**Metal Bracket**  
Replaces: 14336A9, 88183A12  
Fits: 1983 and Later without "quick connect"



**18-6753 HYDRAULIC TRIM PUMP ASSEMBLY**  
**Stainless Steel Bracket**  
Replaces: 14336A9, 88183A12  
Fits: 1983 and Later without "quick connect"

① Items ending in "D" are Display Packaged - Regular number is Non-Display



**18-6768**  
**COMPLETE POWER TRIM PUMP ASSEMBLY**  
**Steel Bracket**  
 Replaces: 93247A7  
 Replacement pump for Prestolite high pressure/low flow system. Primarily used 1982 and earlier.



**18-6799**  
**COMPLETE POWER TRIM PUMP ASSEMBLY**  
**Stainless Steel Bracket**  
 Mercruiser 93247A7  
 Replacement pump for Prestolite high pressure/low flow system. Salt water series. Stainless steel bracket. Primarily used 1982 and earlier.

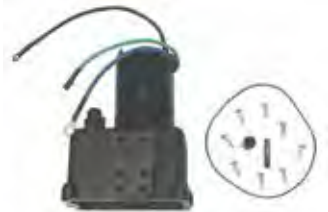

**18-6763**  
**TILT/TRIM MOTOR**  
 Replaces: 92975A6, 79271A4, 67914A2, 92975A32, 93247A7  
 To 1984. Fits most Mercruiser Sterndrives (Motor and Reservoir Only)  
 For Repair Kit use: **18-6253**



**18-6769-1**  
**TILT/TRIM PUMP**  
**Low Pressure - High Flow**  
 Replaces: 14336A8, 88183A5 From 1984  
 Fits most Mercruiser Sterndrives



**18-6772**  
**TILT PUMP MOTOR**  
 Replaces: 17649, 17649T, 891736T  
 For late style Alpha I, Generation II, and Bravo drives; early style square motors.  
 Mercruiser Sterndrive replacement for Oildyne units



**18-6274**  
**TILT/TRIM MOTOR**  
 Replaces: 14336A20  
 Oildyne low pressure/high flow



**18-6813**  
**TRIM MOTOR**  
 Replaces: 14336A6, A8, A9, A15, A20, 88183A5, A8, A12, 865380A13, A25



**18-6771**  
**TILT/TRIM RESERVOIR**  
 Replaces: 18525A1



**18-6778**  
**TILT/TRIM RESERVOIR**  
 Replaces: 883166A2  
 For: Tilt Motors with 4 Screw Attachments



**18-6823**  
**WIRING HARNESS**  
 Replaces: Universal  
 Converts 3-wire Tilt and Trim motors to 2-Wire design



**18-5872**  
**STATOR**  
 Replaces: 398-6231A10  
 For: 3.7L 1983-89



**18-6254**  
**COMMUTATOR END PLATE**  
 Replaces: 392-2940  
 For : Use with Prestolite Pumps (Mercury #'s 79271A4 and 88475A5)



**18-6253**  
**COMMUTATOR END PLATE**  
 For use with **18-6763**



**18-6256**  
**POWER TRIM SPRING SET**  
 Replaces: 392-2529  
 For : Use with Prestolite Pumps (Mercury #'s 74436A9, 79271A4, 88475A5 and 93247A4)



**18-6255**  
**POWER TRIM BRUSH**  
 Replaces: 392-8989  
 For : Use with Prestolite Pumps (Mercury #'s 93247A4)



**18-6293**  
**ALTERNATOR**  
 Replaces: 862031T • SAE J1171  
 7SI/70 amp, Hinge Mount,  
 Serpentine Pulley 2.44" Diameter



**18-6298**  
**ALTERNATOR**  
 Replaces: 863077T • SAE J1171  
 7SI/70 amp, Hinge Mount,  
 Serpentine Pulley 1.97" Diameter



**18-5983**  
**ALTERNATOR**  
 Replaces: 862030T • SAE J1171  
 7SI/70 amp, Hinge Mount, Single Groove Pulley



**18-5956**  
**ALTERNATOR**  
 (1-Wire) (No Core) (68 AMP)  
 Single wire connection fits Mercruiser and many other  
 applications. Equipped with fan and drive pulley.  
 Replaces: 69729 • SAE J1171



**18-5950**  
**ALTERNATOR**  
 (1-Wire) (No Core) (68 AMP)  
 Single wire connection fits Mercruiser and many other ap-  
 plications. Equipped with fan and drive pulley.  
 Replaces: 69729 • SAE J1171  
 (Remanufactured)



**18-5957**  
**ALTERNATOR**  
 (3-Wire) (No Core) (68 AMP)  
 Replaces Mando, Motorola and original equipment  
 Delco. Uses same electrical connections and  
 mounting method. Equipped with fan and drive pulley.  
 Replaces: 78477, 78403A2, 92497A3.  
 • SAE J1171



**18-5951**  
**ALTERNATOR**  
 (3-Wire) (No Core) (68 AMP)  
 Replaces Mando, Motorola and original equipment  
 Delco. Uses same electrical connections and  
 mounting method. Equipped with fan and drive pulley.  
 Replaces: 78477, 78403A2, 92497A3  
 (Remanufactured) • SAE J1171



**18-5946**  
**ALTERNATOR**  
 (1-Wire) (No Core) (68 AMP)  
 Single wire connection fits Mercruiser and many  
 other applications. Equipped with fan and  
 serpentine drive pulley. • SAE J1171



**18-5945**  
**ALTERNATOR**  
 (3-Wire) (No Core) (68 AMP) • SAE J1171  
 Replaces Mando, Motorola and original equipment  
 Delco. Uses same electrical connections and mounting  
 method. Equipped with fan and serpentine drive pulley.



**18-5960**  
**ALTERNATOR**  
 Serpentine Pulley • 65 Amp  
 Replaces: 807653T • SAE J1171



**18-5966**  
**ALTERNATOR**  
 Single Groove Pulley • 55 Amp  
 Replaces: 817119A4, 12449A1 • SAE J1171



**18-5967**  
**ALTERNATOR**  
 Serpentine Pulley • 55 Amp  
 Replaces: 807652T • SAE J1171



**18-5965**  
**ALTERNATOR**  
 65 Amp  
 Replaces: 817119A1,  
 817119A4, 805884T  
 SAE J1171



**18-6841**  
**ALTERNATOR**  
 Replaces: Mercruiser 56045,  
 59755, 69729  
 For: 37-63A Marine Applications



**18-6842**  
**ALTERNATOR**  
 Replaces: Mercruiser 56045,  
 59755, 69729  
 For: 37-63A Marine Applications



**18-6844**  
**ALTERNATOR**  
 Replaces: Mercruiser 834832,  
 T2, 857006A3,  
 Denso 101211-3460







**NEW**

**18-6948  
ALTERNATOR**  
Replaces: Mercury 882571  
Fits: CMD 1.7 MI 120 I/L4, CMD 1.7 MS 120 I/L4, D1.7L DTI



**NEW**

**18-6960  
ALTERNATOR**  
Replaces: Mercruiser 821663, -1, A1, Denso 101211-3020, 3021



**18-5953-1  
ALTERNATOR CONVERSION KIT**  
Includes new 68 AMP alternator, mounting brackets 18-5968, pulley, wiring, hardware and instructions. Converts model 470 aluminum block Mercruiser engines serial number 4625580 & up with stator charging system and water cooled voltage regulator to alternator system. **NOTE: Fuse kit 18-8220 (sold separately) is required on engines with a Delco starter (round solenoid mounted to starter); Prestolite starters with remote solenoid DO NOT require fuse kit. Visually inspect starter prior to ordering conversion kit**

**CE**  
**MARINE**  
**UL**  
**LISTED**



**18-5949  
CONVERSION KIT DRIVE BELT**  
Replacement belt for alternator conversion kit used on 470 Series Mercruisers. Included in 18-5953-1 kit.



**18-5968  
ALTERNATOR BRACKET**  
Replacement bracket for alternator conversion kit used on 470 Series Mercruiser included in 18-5953 kit



**18-8220  
FUSE KIT**  
Replace: 88-79023A91  
For use with 18-5953 alternator conversion kits installed on Mercruiser (Model 470) 3.7 liter aluminum block engines serial number 6902288 & Up.  
90 AMP



**18-5740  
VOLTAGE REGULATOR**  
Replaces: 42785

Model #	Cyl.	Years	Beg. S/N	End. S/N	Slave Solenoid	Reman Starter	New Starter	Reman Alternator	New Alternator
110	GM 4	1963-1966	1538370	2044033	18-5836	18-5900	18-5911	—	—
120	GM 4	1964-1975	1666601	4469865	18-5836	18-5900	18-5911	18-5951	18-5957
120	GM 4	1976-1982	4469866	6229717	18-5815	18-5900	18-5911	18-5951	18-5957
120 / 2.5L	GM 4	1983-1989	6229718	C853255	18-5817	18-5900	18-5911	—	18-5966 ④
140	GM 4	1968-1975	2508261	4460664	18-5836	18-5900	18-5911	18-5951	18-5957
140	GM 4	1976-1981	4460665	6229717	18-5815	18-5900	18-5911	18-5951	18-5957
140/3.0L	GM 4	1982-1989	6229718	C856558	18-5817	18-5900	18-5911	18-5951	18-5957
140/3.0L	GM 4	1999-2001	OL382122	OM326292	18-5817	—	18-6275	—	18-5983 **
140/3.0L/3.0LX	GM 4	1990-92	C856559	D831100	18-5817	18-5900	18-5911	18-5951	18-5957
140/3.0LX	GM 4	1992-97	D831101	OK999999	18-5817	N/A	18-6275	—	18-5966 ④
165/3.7L	Merc 4	1987-1989	B434941	C762299	18-5802	18-5901	18-5907	N/A	N/A
170	Merc 4	1985-1986	6916779	B434940	18-5802	18-5901	18-5907	N/A	N/A
180/3.7LX	Merc 4	1987-1989	B436391	C762299	18-5802	18-5901	18-5907	N/A	N/A
190	Merc 4	1985-1986	6916779	B436390	18-5802	18-5901	18-5907	N/A	N/A
470	Merc 4	1976-1984	4208730	6916778	18-5802	18-5901	18-5907	N/A	N/A
470MIE	Merc 4	1980-1981	5520115	6218036	18-5802	18-5901	18-5907	N/A	N/A
485	Merc 4	1980-1984	5685394	6916778	18-5802	18-5901	18-5907	N/A	N/A
140	GM 6	1963	1538930	1725960	18-5836	18-5900	18-5911	—	—
150	GM 6	1964-66	1666495	2048046	18-5836	18-5900	18-5911	—	—
160	GM 6	1967-69	2048022	2768031	18-5836	18-5900	18-5911	—	—
160	GM 6	1969	2768032	2770031	18-5836	18-5900	18-5911	18-5951	18-5957
165	GM 6	1970-1975	2770032	4471565	18-5836	18-5900	18-5911	18-5951	18-5957
165	GM 6	1976-1981	4471566	5813433	18-5815	18-5900	18-5911	18-5951	18-5957
200	GM 6	1969	2453769	2712072	18-5836	18-5900	18-5911	—	—
175/4.3L	GM V-6	1987-1992	B527955	D714106	18-5816	—	18-5913	—	18-5966 ④
185	GM V-6	1983-1984	6330183	6919655	18-5816	18-5900	18-5911	—	18-5966 ④
185	GM V-6	1985-1987	A331455	B527954	18-5816	N/A	18-5913	—	18-5966 ④
205	GM V-6	1985-1991	A331455	D714369	18-5816	N/A	18-5913	—	18-5966 ④
262 Mag. EFI	GM V-6	1996-1997	F803800	K999999	18-5817	N/A	18-5913	—	18-5960
262 Mag. EFI	GM V-6	1996-1997	F803800	K999999	18-5817	N/A	18-5913	—	18-5960
4.3L/LX/LXH	GM V-6	1992-1997	D714107	K999999	18-5817	—	18-5913	—	18-5967
4.3L/LX/LXH	GM V-6	1996-1997	F803000	K999999	18-5817	—	18-5913	—	18-5967
4.3L/LH	GM V-6	1998-99	L010044	OL618999	18-5817	—	18-5913	—	18-5967
4.3L/LH(Gen +)	GM V-6	2000-02	OL619000	OM320024	18-5817	—	18-5913	—	18-6293 **
4.3EFI	GM V-6	1998-99	L012009	OL618999	18-5817	—	18-5913	—	18-5960
4.3L EFI	GM V-6	2000-01	OL619000	OM299999	18-5817	—	18-5913	—	18-6293 **
4.3L MPI	GM V-6	2002	OM300000	OM320024	18-5817	—	18-5913	—	18-6293 **
190	GM V-8	1963-1964	1564539	1730903	18-5836	18-5900	18-5911	—	—
200	GM V-8	1985-1986	6218462	B525981	18-5816	18-5900	18-5911 ① ③	—	18-5966 ④
200	GM V-8	1985-1986	6218462	B525981	18-5816	18-5905	18-5910 ② ⑥	—	18-5966 ④
200/5.0L	GM V-8	1987-1995	B525982	F600999	18-5816	18-5905	18-5910	—	18-5966 ④
200/5.0L	GM V-8	1987-1995	B525982	F600999	18-5817	18-5905	18-5910	—	18-5966 ④
215 MCM & MIE	Ford V-8	1970-1972	2781153	3563181	18-5836	18-5902	18-5908 ①	18-5951	18-5957

① For 12 3/4" Dia. Flywheel  
 ② For 14" Dia. Flywheel  
 ③ For permanent magnet models use 18-5919  
 ④ 55 AMP up grade to 65 AMP use 18-5965  
 ⑤ Black  
 ⑥ For permanent magnet models use 18-5913  
 ⑦ Bravo drive  
 ⑧ Firepower ignition  
 ⑨ Ignition module mounted on distributor  
 ⑩ Ignition module mounted on elbow  
 ⑪ LH rotation  
 ⑫ NLA for models prior to S/N 4167000  
 ⑬ PG 260 (9-1/4" long)  
 ⑭ PG260F1 (8-1/2" long)  
 ⑮ RH Rotation  
 ⑯ Standard ignition  
 ⑰ Thunderbolt ignition  
 ⑱ Thunderbolt IV  
 ⑲ Thunderbolt V  
 ⑳ Transmission models  
 \*\* Delco Style







**18-7683  
FUEL PRESSURE REGULATOR**  
Replaces: 849899  
Fits: MCM 500 EFI



**18-7662  
FUEL PRESSURE  
REGULATOR**  
Replaces: 885174  
4.3L, 5.0L, 5.7L & 6.2L MPI engines with  
555 ECM-regulator mounted on fuel rail



**18-7663  
FUEL PRESSURE  
REGULATOR**  
Replaces: 802630T01  
7.4L MPI (L29)



**18-7652  
FUEL PRESSURE  
REGULATOR**  
Replaces: 805227A1



**18-7600  
TEMPERATURE SENSOR**  
Replaces: 805218T



**18-7700  
THROTTLE  
POSITION SENSOR**  
Replaces: 853678T  
Fits: MCM/MIE 4.3L MPI, 5.0L MPI,  
MX6.2L MPI w/ECM 555 and 350 Mag  
MPI, Black Scorpion Tow Sports, 377  
Scorpion Tow Sports, 7.4L MPI(L29) &  
MCM 496 Mag & HO and MIE 8.1S & HO



**18-7630  
THROTTLE POSITION  
SENSOR**  
Replaces: 805226A1



**18-7701  
IDLE SPEED  
CONTROL MOTOR**  
Replaces: 862998  
Fits: MCM 3.0L MPI, V6 & V8(305, 350  
& 496 cid)MPI engines w/ECM555



**18-7697  
IAC MOTOR**  
Replaces: 803149  
Fits: MCM/MIE 350 Mag MPI, Black  
Scorpion Tow Sports, 377 Scorpion  
MCM & Tow Sports, MX6.2L MPI, 7.4L  
MPI(L29) & 575 Sci



**18-7632  
IDLE AIR CONTROL MOTOR**  
Replaces: 805224A1



**18-7682  
MAP SENSOR**  
Replaces: 849934  
Fits: MCM 575 Sci



**18-7684  
MAP SENSOR**  
Replaces: 864856A1  
Fits: MCM/MIE GM V6 & V8 (350, 377,  
454 & 502cid)EFI Engines



**18-7660  
MAP SENSOR**  
Replaces: 881731  
V-6 & V-8 MPI engines with 555 ECM



**18-7668  
MAP SENSOR**  
Replaces: 854445  
525 EFI



**18-7677  
KNOCK SENSOR**  
Replaces: 806612T  
Fits: GM V8(305, 350 & 377 cid) engines



**18-7703  
KNOCK SENSOR**  
Replaces: 805544T



**18-7646  
CAMSHAFT SENSOR**  
Replaces: 892615002



**18-7685  
TBI INJECTOR**  
Replaces: 852956A1  
Fits: MCM GM V6 & V8 (305 & 350 cid)  
TBI engines



**18-7686  
FUEL INJECTOR**  
Replaces: 849896  
Fits: MCM 500 EFI



**18-7688**  
**FUEL INJECTOR**  
 Replaces: 885176  
 Fits: MCM 4.3L MPI engines (s/n OM300000-1A063239) & 5.0L, 5.7L & 6.2L MPI engines w/ ECM 555 (s/n OM300000-1A064824)



**18-7698**  
**FUEL INJECTOR**  
 Replaces: 881693002  
 Fits: MCM 496 Mag & HO and MIE 8.1S & HO

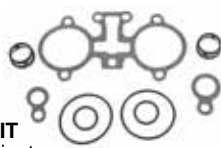

**18-7690**  
**INJECTOR SEAL KIT**  
 Use with Mercury Injector # 852956A1, 853998A1  
 Fits: 262 Mag EFI (1996-97), 4.3L EFI (1998-01), 5.0L EFI (1998-01), 350 Mag Alpha EFI (Gen+) (1996-97), 350 Mag EFI SKI (1994-97), 5.7L EFI (1995-01), 5.7L EFI MIE (Gen+) (1997), 5.7L LX Bravo EFI (Gen+) (1996-97), 5.7 LX EFI (1995-97), 7.4L LX TBI (1996-97), 575 Sci (2000-05)



**18-7691**  
**INJECTOR SEAL KIT**  
 Use with Mercury Injector # 806807A1  
 Fits: 350 Mag Bravo MPI (1995-96), Black Scorpion SKI (1996)



**18-7692**  
**INJECTOR SEAL KIT**  
 Use with Mercury Injector # 861260T  
 Fits: 350 Mag MPI(98-01), 350 Mag MPI Horizon MIE(99-01), 350 Mag MPI MIE(98-01), 350 Mag MPI SKI(98-01), MX 6.2L MPI(00-01), 454 Mag MPI(99-01), 454 Mag MPI Horizon MIE(99-01), 502 Mag MPI(99-01), 8.2L MPI(99-01)



**18-7693**  
**INJECTOR SEAL KIT**  
 Use with Mercury Injector # 802632T, 849896  
 Fits: 7.4L MPI(L29)(98-01), 7.4L MPI MIE(L29)(98-01), 500 EFI(99-05)



**18-7694**  
**INJECTOR SEAL KIT**  
 Use with Mercury Injector # 881693002  
 Fits: 496 Mag (2001-08), 496 Mag DTS (2001-08), 496 Mag HO (2001-08), 496 Mag HO DTS (2001-08), 8.1L MIE (2001-08), 496 Mag DTS (2001-08), 8.1L HO MIE (2001-08), 496 Mag HO DTS (2001-08)



**18-7695**  
**INJECTOR SEAL KIT**  
 Use with Mercury Injector # 885176  
 Fits: 4.3L MPI(02-08), 5.0L MPI(02-08), 5.0L MPI DTS(05-08), 350 Mag MPI(02-08), 350 Mag MPI DTS(05-08), 350 Mag MPI Horizon(02-07), 350 Mag MPI MIE(02-07), 350 Mag MPI MIE DTS(05-07), 350 Mag MPI SKI(02-07), 350 Mag MPI SKI DTS(05-07), 350 Mag MPI SKI MIE(08), 5.7L MPI SKI(08), MX6.2L MPI(02-07), MX6.2L MPI DTS(05-07), MX6.2L MPI Horizon(04-07), MX6.2L MPI Horizon DTS(05-07), MX6.2L MPI Horizon MIE(02-08), MX6.2L MPI Horizon MIE DTS(05-08), MX 6.2L MPI MIE(02-07), MX6.2L MPI MIE DTS(05-07), MX6.2L MPI SKI(02-07)



**18-7696**  
**INJECTOR SEAL KIT**  
 Use with Mercury Injector # 805225A1  
 Fits: 320 EFI(87-89), 350 Mag Bravo MPI(Gen+)(97), Black Scorpion SKI(97-08), 377 Scorpion MCM(99-05), 377 Scorpion SKI(97-98), MX6.2L Black Scorpion SKI (01-07), 454 Mag EFI SKI(94-97), 454 Mag MPI(96-98), 454 Mag MPI Horizon MIE(98), 7.4L MPI MIE(95-97), 7.4LX MPI(96-97), 502 Mag MPI(93-98), 525 EFI(03-08), 8.2L MPI MIE(96-98)

**FUEL INJECTION SYSTEM APPLICATION**

Model	Liter	CID	# Cyl	Year Range	Serial # Range	Injector	IAC Valve	TPS	F/P Regulator Rail-Mounted	F/P Regular Cooler Mounted	MAP Sensor
3.0L MPI	3.0L	181	L4	2008-2010	A072812 & UP	N/A	18-7701	N/A	N/A	N/A	N/A
262 MAG EFI	4.3L	262	V-6	1996-1997	F803800 - K999999	18-7685	18-7632	18-7630	N/A	N/A	18-7684
4.3L EFI	4.3L	262	V-6	1998-2001	L012009 - M299999	18-7685	18-7632	18-7630	N/A	N/A	N/A
4.3L MPI	4.3L	262	V-6	2002-2007	M300000 - A063239	18-7688	18-7701	18-7700	18-7662	N/A	N/A ②
4.3L MPI	4.3L	262	V-6	2007-2010	A063240 & UP	N/A	18-7701	18-7700	18-7662	N/A	N/A ②
5.0L EFI	5.0L	305	V-8	1998-2001	L012052 - M299999	18-7685	18-7632	18-7630	N/A	N/A	N/A
5.0L MPI	5.0L	305	V-6	2002-2007	M300000 - A064824	18-7688	18-7701	18-7700	18-7662	N/A	N/A ②
5.0L MPI	5.0L	305	V-6	2007-2010	A064825 & UP	N/A	18-7701	18-7700	18-7662	N/A	N/A ②
5.0L MPI DTS	5.0L	305	V-8	2005-2007	W310000 - A064824	18-7685	N/A	N/A	18-7662	N/A	N/A
5.0L MPI DTS	5.0L	305	V-8	2010	A064825 & UP	N/A	N/A	N/A	18-7662	N/A	N/A
350 MAG ALPHA EFI (GEN +)	5.7L	350	V-8	1996-1997	F800300 - K999999	18-7685	18-7632	18-7630	N/A	N/A	18-7684
350 MAG BRAVO MPI	5.7L	350	V-8	1995-1996	F415189 - K001500	N/A	18-7632	18-7630	N.L.A.	N/A	18-7684 ②
350 MAG BRAVO MPI (GEN +)	5.7L	350	V-8	1997	K001501 - K999999	N/A	18-7632	18-7630	N/A	N/A	18-7684 ②
350 MAG EFI SKI	5.7L	350	V-8	1994-1996	F215561 - F820706	18-7685	18-7632	18-7630	N/A	N/A	18-7684
350 MAG EFI SKI	5.7L	350	V-8	1996	F820707 - K040005	18-7685	18-7632	18-7630	N/A	N/A	18-7684
350 MAG MPI	5.7L	350	V-8	1998	L010019 - L331598	N/A	18-7697	18-7700	N/A	N/A	N/A
350 MAG MPI	5.7L	350	V-8	1998	L336000 - L346999	N/A	18-7697	18-7700	N/A	N/A	N/A
350 MAG MPI	5.7L	350	V-8	1999	L331599 - L335999	N/A	18-7697	18-7757	N/A	N/A	N/A
350 MAG MPI	5.7L	350	V-8	1999-2001	L340000 - M299999	N/A	18-7697	18-7757	N/A	N/A	N/A
350 MAG MPI	5.7L	350	V-8	2002-2007	M300000 - A064824	18-7688	18-7701	18-7700	18-7662	N/A	N/A ②
350 MAG MPI DTS	5.7L	350	V-8	2005-2007	W310000 - A064824	18-7688	N/A	N/A	18-7662	N/A	N/A ②
350 MAG MPI DTS	5.7L	350	V-8	2007-2010	A064825 & UP	N/A	N/A	N/A	18-7662	N/A	N/A ②
350 MAG MPI HORIZON	5.7L	350	V-8	2002-2007	M300000 - A064824	18-7688	18-7701	18-7700	18-7662	N/A	N/A ②
350 MAG MPI HORIZON	5.7L	350	V-8	2007	A064825 - A299999	N/A	18-7701	18-7700	18-7662	N/A	N/A ②
350 MAG MPI HORIZON DTS	5.7L	350	V-8	2005-2007	W310000 - A064824	18-7688	N/A	N/A	18-7662	N/A	N/A ②
350 MAG MPI HORIZON DTS	5.7L	350	V-8	2007	A064825 - A299999	N/A	N/A	N/A	18-7662	N/A	N/A ②
350 MAG MPI HORIZON MIE	5.7L	350	V-8	1999-2001	L304700 - M299999	N/A	18-7697	18-7757	N/A	N/A	N/A
350 MAG MPI HORIZON MIE	5.7L	350	V-8	2002-2004	M300000 - M398371	18-7688	18-7701	18-7700	18-7662	N/A	N/A ②
350 MAG MPI HORIZON MIE	5.7L	350	V-8	2004-2007	M398372 - A064824	18-7688	18-7701	18-7700	18-7662	N/A	N/A ②
350 MAG MPI HORIZON MIE	5.7L	350	V-8	2007	A064825 - A089999	N/A	18-7701	18-7700	18-7662	N/A	N/A ②
350 MAG MPI HORIZON MIE DTS	5.7L	350	V-8	2005-2007	W390000 - A064824	18-7688	N/A	N/A	18-7662	N/A	N/A ②
350 MAG MPI HORIZON MIE DTS	5.7L	350	V-8	2007	A064825 - A089999	N/A	N/A	N/A	18-7662	N/A	N/A ②
350 MAG MPI MIE	5.7L	350	V-8	1998	L002008 - L302199	N/A	18-7697	18-7700	N/A	N/A	N/A
350 MAG MPI MIE	5.7L	350	V-8	1999-2001	L302200 - M299999	N/A	18-7697	18-7757	N/A	N/A	N/A
350 MAG MPI MIE	5.7L	350	V-8	2002-2004	M300000 - M398371	18-7688	18-7701	18-7700	18-7662	N/A	N/A ②
350 MAG MPI MIE	5.7L	350	V-8	2004-2007	M398372 - A064824	18-7688	18-7701	18-7700	18-7662	N/A	N/A ②
350 MAG MPI MIE	5.7L	350	V-8	2007	A064825 - A089999	N/A	18-7701	18-7700	18-7662	N/A	N/A ②
350 MAG MPI MIE DTS	5.7L	350	V-8	2005-2007	W390000 - A064824	18-7688	N/A	N/A	18-7662	N/A	N/A ②
350 MAG MPI MIE DTS	5.7L	350	V-8	2007	A064825 - A089999	N/A	N/A	N/A	18-7662	N/A	N/A ②
350 MAG EFI SKI	5.7L	350	V-8	1994-1996	F215561 - F820706	18-7685	18-7632	18-7630	N/A	N/A	18-7684
350 MAG MPI SKI	5.7L	350	V-8	1998	L002600 - L304599	N/A	18-7697	18-7700	N/A	N/A	N/A
350 MAG MPI SKI	5.7L	350	V-8	1999-2001	L304600 - M299999	N/A	18-7697	18-7757	N/A	N/A	N/A
350 MAG MPI SKI	5.7L	350	V-8	2002-2007	M300000 - A064824	N/A	18-7701	18-7700	18-7662	N/A	N/A ②

① BRAVO APPS WSN W060000, ORDER REGULATOR # 892681      ② MAPT SENSOR (TEMP & PRESSURE)





**18-7627**  
**INTAKE MANIFOLD**  
 Small-block GM with vortec cylinder heads



**18-7628**  
**INTAKE MANIFOLD**  
 Small-block GM with vortec cylinder heads with brass lined water jackets

**ALL SIERRA CARBURETORS INCLUDE BASE GASKET**

- Precision remanufactured to meet or exceed OEM specifications
- Re-calibrated and re-engineered to maximize fuel efficiency and performance
- All carburetors are flow tested throughout the entire throttle range
- Fuel mixture and idle settings are pre-set to ensure that only minor idle and choke adjustments are necessary during installation
- All bases are resurfaced and throttle shaft bushings replaced



**18-7373N**  
**MERCARB 2V CARBURETOR**  
 Replaces: Mercruiser 3310-864941A01  
 2002-2004 4.3L engines (s/n OM615000-OW300012)



**18-7615N**  
**Q-JET CARBURETOR**  
 Replaces: 1347-816373A4,  
 1347-804624R1, 1347-804624R02



**18-7639**  
**CARBURETOR**  
 Replaces: 3310-864943A01  
 Mercarb-5.7L 2V 1998 and newer 5.7L  
 (OL010337-OW300754) & 5.7L MIE  
 (OL002003-OW090899)  
**(Remanufactured)**



**18-7640**  
**CARBURETOR**  
 Universal Q-jet with electric choke  
**(Remanufactured)**



**18-7603-1**  
**CARBURETOR**  
 2 Barrel - Rochester  
 Replaces: 1347-818622,  
 1376-5659A1, 1347-818622 1,  
 1347-818622R02  
**(Remanufactured)**



**18-7604-1**  
**CARBURETOR**  
 4 Barrel - Rochester  
 Replaces: 3304-9354A2,  
 1347-804623R02  
**(Remanufactured)**



**18-7605-1**  
**CARBURETOR**  
 4 Barrel - Rochester  
 Replaces: 1347-9661A3,  
 1347-804623A1,  
 1347-804623R02  
**(Remanufactured)**



**18-7608-1**  
**CARBURETOR**  
 2 Barrel - Rochester  
 Replaces: 1347-818620,  
 1347-818620 1, 1347-818620R02  
**(Remanufactured)**



**18-7609-1**  
**CARBURETOR**  
 2 Barrel - Rochester  
 Replaces: 1347-818619,  
 1347-818619 1, 1347-818619 1R  
**(Remanufactured)**









**18-7610-1**  
**CARBURETOR**  
 2 Barrel - Rochester  
 Replaces: 1347-818621, 1347-818621 1,  
 1347-818621 1R02  
**(Remanufactured)**



**18-7611-2**  
**CARBURETOR**  
 2 Barrel - Rochester  
 Replaces: 3310-807312A1,  
 3310-807312R02  
**(Remanufactured)**

**ALL SIERRA CARBURETORS INCLUDE BASE GASKET**

 <p><b>18-7613-1 CARBURETOR</b> 4 Barrel - Carter (Weber) Replaces: 3310-806969A1, 3310-806969R01 <b>(Remanufactured)</b></p>	 <p><b>18-7615-1 CARBURETOR</b> 4 Barrel - Rochester Replaces: 1347-816373A4, 1347-804624R1, 1347-804624R02 <b>(Remanufactured)</b></p>	 <p><b>18-7616-1 CARBURETOR</b> 4 Barrel - Rochester Replaces: 1347-8288A1, 1347-804626R02 <b>(Remanufactured)</b></p>
 <p><b>18-7617-1 CARBURETOR</b> 4 Barrel - Rochester Replaces: 1347-9863A3, 1347-804624R1, 1347-804625R02 <b>(Remanufactured)</b></p>	 <p><b>18-7618-1 CARBURETOR</b> 4 Barrel - Rochester Replaces: 1347-8289A1, 1347-804624R1, 1347-804624R02 <b>(Remanufactured)</b></p>	 <p><b>18-7619-1 CARBURETOR</b> 4 Barrel - Rochester Replaces: 1347-9142A2, 1347-8460A3 <b>(Remanufactured)</b></p>

**CARBURETOR APPLICATION**

Model	CID / # Cyl	Year Range	Beginning Serial #	Ending Serial #	Original Carb Part Number	Carb Code / Model	Carb Repair Kit	Replacement O.E. Carb. Number	Float	Sierra Carb #
90	96/L4	1970-1971	2851424	3225967	1351- 4263A 1	7040082 R2/2GC	18-7746	1347-818619R02	18-7200	18-7609-1
90	96/L4	1972	3225868	3226957	1351- 4263A 1	7036543 R2/2GC	18-7746	1347-818619R02	18-7200	18-7609-1
110	153/L4	1963-1966	1357370	2044033	1336-2076	R2/2GC	—	—	—	18-7609-1
120	153/L4	1972-1973	3377341	3770649	1351-4263A3	7043182 R2/2GC	18-7746	1347-818619R02	18-7200	18-7609-1
120	153/L4	1974-1975	3770650	4469865	1351-5202A1	7044182 R2/2GC	18-7746	1347-818619R02	18-7200	18-7609-1
120	153/L4	1976-1978	4469866	5192048	1351-6065A2	7044182 R2/2GC	18-7746	1347-818619R02	18-7200	18-7609-1
120	153/L4	1979-1982	5192049	6229717	1351-7354A1	17059054 R2/2GC	18-7746	1347-818619R02	18-7200	18-7609-1
120	153/L4	1983	6229718	6663797	1351- 8480A 2	17081060 R2/2GC	18-7746	1347-818621R02	18-7200	18-7610-1
120	153/L4	1984	6663798	6853913	1389- 8490A 2	M2/MERCARB	18-7097	3310-860070A 2	18-7202	—
120	153/L4	1985	6853914	A492055	1389- 9350A 2	M2/MERCARB	18-7097	3310-860070A 2	18-7202	—
120	153/L4	1986	A492056	B531853	1389- 9562A 1	M2/MERCARB	18-7098-1	3310-860070A 2	18-7202	—
2.5L	153/L4	1983-1989	B531854	C853255	3310-806077A 2	M2/MERCARB	18-7098-1	3310-860070A 2	18-7202	—
140	181/L4	1968-1969	2508261	2816416	1351- 3635A 1	7036646 R/2GC	18-7746	—	18-7200	—
140	181/L4	1970	2816417	2911439	1351- 4032A 1	7040080 R/2GC	18-7746	1347-818620R02	18-7200	18-7608-1
140	181/L4	1970-1973	2911440	3771644	1351-4293A1	7040084 R/2GC	18-7746	1347-818620R02	18-7200	18-7608-1
140	181/L4	1974-1978	3771645	5157668	1351-5203A1	7043184 R/2GC	18-7746	1347-818620R02	18-7200	18-7608-1
140	181/L4	1979-1982	5157669	6229717	1351-7355A1	17059052 R/2GC	18-7746	1347-818620R02	18-7200	18-7608-1
140	181/L4	1983	6229718	6671328	1351- 8480A 2	17081060 R/2GC	18-7746	1347-818521R02	18-7200	—
140	181/L4	1984	6671329	6852269	1389- 8490A 2	M2/MERCARB	18-7097	3310-860070A 2	18-7202	—
140	181/L4	1985	6852270	A484072	1389- 9350A 2	M2/MERCARB	18-7097	3310-860070A 2	18-7202	—
140	181/L4	1986	A484073	B450800	1389- 9562A 1	M2/MERCARB	18-7098-1	3310-860070A 2	18-7202	—
140/3.0L	181/L4	1983-1989	6229718	C856556	1351-8480A2	R2/2GC	—	1348-818621 1	—	18-7610-1
3.0L	181/L4	1987-1989	B450801	C856556	3310-806077A 2	M2/MERCARB	18-7098-1	3310-860070A 2	18-7202	—
3.0L	181/L4	1990	C856559	D447414	1389-815396A 2	M2/MERCARB	18-7098-1	3310-860070A 2	18-7202	—
3.0L	181/L4	1991-1993	D447415	D836075	1389-806077A 2	M2/MERCARB	18-7098-1	3310-860070A 2	18-7202	—
3.0L	181/L4	1993-1994	D836076	F603999	1389-806078A 1	M2/MERCARB	18-7098-1	3310-860070A 2	18-7202	—
3.0L	181/L4	1998-2002	L010042	M385672	3310-807504A 1	M2/MERCARB	18-7098-1	3310-8M0045397	18-7202	—
3.0L	181/L4	2003-2004	M385673	W301999	3310-864940A01	M2/MERCARB	18-7098-1	3310-8M0045397	18-7202	—
3.0L	181/L4	1999-2004	L382122	W301999	3310-864940A01	M2/MERCARB	18-7098-1	865959A01	18-7202 ⑤	—
3.0L	181/L4	2004-2010	W302000	& UP	3310-866140A02	M2/MERCARB	18-7098-1	3310-866140A02	18-7202	—
3.0LX	181/L4	1990-1997	C856559	K999999	1389-815397A 2	M2/MERCARB	18-7098-1	3310-8M0045397	18-7202	—
3.0LX	181/L4	1990-1997	C856559	K999999	3310-805924A 2	M2/MERCARB	18-7098-1	3310-8M0045397	18-7202	—
165 (4 CYL)	224/L4	1987	B434941	B774251	1389- 9564A 1	M2/MERCARB	18-7098-1	3310-860071A 2	18-7202	—
170	224/L4	1985-1989	6916779	B434940	1389- 9564A 1	M2/MERCARB	18-7098-1	3310-860071A 2	18-7202	—
180	224/L4	1987	B436391	B775248	1347- 9142A 2	17083522 R4/4ME	18-7077	—	18-7201	—
190 (4 CYL)	224/L4	1985-1986	6916779	B436390	1347- 9142A 2	17083522 R4/4ME	18-7077	—	18-7201	—
3.7L	224/L4	1988-1989	B774252	& UP	1389- 9564A 1	M2/MERCARB	18-7098-1	3310-860071A 2	18-7202	—

- ① Automatic Choke
- ② Black
- ③ Blue
- ④ Electric Choke
- ⑤ Front (Blue)

- ⑥ On-Line
- ⑦ Rear (Blue)
- ⑧ Spacer Mounted
- ⑨ Use if original carb is MERCARB
- ⑩ Use if original carb is Rochester

- ⑪ Use with in-line transmission
- ⑫ Use with V-drive transmission
- ⑬ V-drive
- ⑭ Wedge mounted
- ⑮ TKS Retrofit Kit







# CARBURETOR APPLICATION

Model	CID / # Cyl	Year Range	Beginning Serial #	Ending Serial #	Original Carb Part Number	Note	Carb Code / Model	Carb Repair Kit	Replacement O.E. Carb. Number	Float	Note	Sierra Carb #
7.4L BRAVO III	454/V-8	1996-1997	F800700	K999999	3310-806969A1		9780 WEBER	18-7748	3310-806969A 1	—		18-7613-1
7.4L MIE	454/V-8	1988-1992	5889914	D715493	1347- 8268A 1		17080560 R4/4MV	18-7077	1347-804626R02	18-7201		18-7616-1
460	482/V-8	1983-1986	4179554	B485220	1393- 8862A 1		H4	18-7751	—	—		—
465	502/V-8	1990-1992	C849992	F213244	—		H4	18-7751	—	—	②	—
465	502/V-8	1990-1992	C849992	F213244	—		H4	18-7751	—	—	③	—
500	502/V-8	1994-1995	F213293	F615766	13549A12		H4	18-7751	—	—	③	—
500	502/V-8	1996-1998	F615767	L001772	13549A 15		H4	18-7751	—	—	③	—
500 (GEN +)	502/V-8	1999	L414639	L601036	13549T21		H4	18-7751	—	—	③	—
502 MAG	502/V-8	1990-1992	C878221	D824588	1347-814623A 2		17089112 R4/4MV	18-7077	—	18-7201		—
502 MAG	502/V-8	1992-1993	D824589	F114528	3310-806971A 1		9782 WEBER	18-7748	—	—		—
8.2L MIE	502/V-8	1990-1992	C878221	D857199	1347-814623A 2		17089113 R4/4MV	18-7077	—	—		—
8.2L MIE	502/V-8	1990-1992	C878221	D857199	3310-817693A 1		9774 WEBER	18-7748	—	—		—
8.2L MIE	502/V-8	1993-1996	D857200	F819619	3310-806971A 1		9782 WEBER	18-7748	—	—		—
500 BULLDOG	540/V-8	1990-1995	C577254	F348987	13549A10		H4	18-7751	—	—	③	—
500 BULLDOG	540/V-8	1995-2001	F615762	M050281	13549A23		H4	18-7751	—	—	③	—

- ① Automatic Choke
- ② Black
- ③ Blue
- ④ Electric Choke
- ⑤ Front (Blue)

- ⑥ On-Line
- ⑦ Rear (Blue)
- ⑧ Spacer Mounted
- ⑨ Use if original carb is MERCarb
- ⑩ Use if original carb is Rochester

- ⑪ Use with in-line transmission
- ⑫ Use with V-drive transmission
- ⑬ V-drive
- ⑭ Wedge mounted
- ⑮ TKS Retrofit Kit

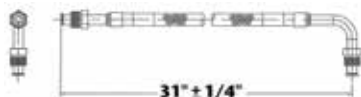

**18-8114  
FUEL LINE HOSE**

For fuel pump to carburetor connection. Replaces copper or steel tubing 3/8" X 31" PTFE composite hose with 5/8"-18 male inverted flare straight one end, 5/8"-18 90° one end. SAE J1527 type A1

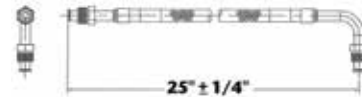

**18-8115  
FUEL LINE HOSE**

For fuel pump to carburetor connection. Replaces copper or steel tubing 3/8" X 25" PTFE composite hose with 5/8"-18 male inverted flare straight one end, 5/8"-18 90° one end. SAE J1527 type A1



**18-7751  
CARB KIT**  
Replaces: 13220

Fits: GM 420 V8 454 (1987-89), GM 425 V8 454 (1990-93), GM 425 (Gen V) V8 454 (1992-93), 440 TRS GM 454 (1983-86), GM 450 V8 454 (1995-96), 460 TRS V8 482 (1983-86), GM 465 V8 502 (1990-92), GM 465 (Gen V) V8 502 (1992-94), 500 (Gen+) GM 502 V8 (1999), 500 (Gen V) 502 V8 (1994-98), 500 Bulldog 540 V8 (1990-01)



**18-7071  
CARB KIT**  
Replaces: 1397-3458



**18-7075  
CARB KIT**  
Replaces: 1397-5830, 1397-7099, 1397-8760, 1397-5831



**18-7070  
CARB KIT**  
Replaces: 1397-2072, 1397-7542, 1397-2637, 1397-7543, 1397-8872, 1397-3464,



**18-7072**  
**CARB KIT**  
 Replaces: 1397-3306, 1397-4329,  
 1397-5635, 1397-6638, 823426A1

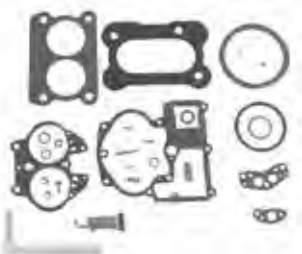

**18-7076**  
**CARB KIT**  
 Replaces: 1397-6367, A1



**18-7077**  
**CARB KIT**  
 Replaces: 1397-8952, 823426A1



**18-7078**  
**CARB KIT**  
 Replaces: 1397-2605



**18-7080**  
**CARB KIT**  
 Replaces: 1398-3089



**18-7081**  
**CARB KIT**  
 Replaces: 1396-4656  
 Contains adjustable needles and seats



**18-7095**  
**CARB KIT**  
 Replaces: 1397-7539, 1397-7540,  
 1397-7544, 1397-8535, 1397-9723



**18-7096**  
**CARB KIT**  
 Replaces: 1396-5238, 1396-5222  
 Contains adjustable needles and seats



**18-7097**  
**CARB KIT**  
 Replaces: 3302-9437, 3302-804845  
 MerCarb 2 bbl. bottom fill accelerator pump 1983-1986  
 MCM 120, 140, 470, 185, 200, 898.

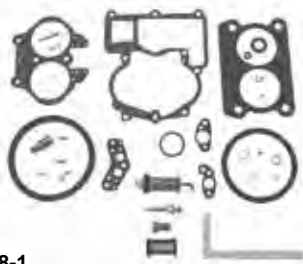

**18-7098-1**  
**CARB KIT**  
 Replaces 3302-804844002  
 MerCarb 2 bbl. side fill accelerator pump  
 1986 and UP MCM 4-cyl., V6 & V8



**18-7728**  
**CARB KIT**



**18-7749**  
**CARB KIT**  
 Replaces: 809065, 835076, 823728



**18-7748**  
**CARB KIT**  
 Replaces: 809064

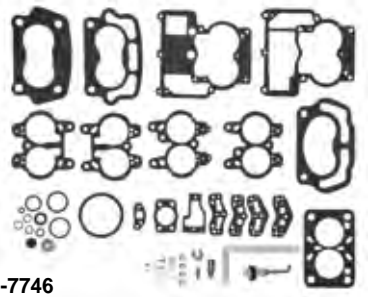

**18-7746**  
**CARB KIT**  
 Replaces: 823427A1  
 Repair Kit for 2 BBL Rochester



**18-7200**  
**FLOAT**  
 Replaces: 1397-2060  
**(Alcohol Resistant)**  
 Plastic



**CARBURETOR KIT/FLOAT APPLICATION**

Model & Serial #	Mercruiser Carb. #	Mfg. Carb. #	Carb. Code & Model	Carb. Kit ①	Float
<b>MCM 80 ALL</b>	1346-2770	RBS-4394S	C1/RBS	18-7080	—
<b>MCM 90</b>					
3225967 & BELOW	1351-4263A1	7040082	R2/2GC	18-7746	18-7200
3225968 & ABOVE	1351-4263A2	7041369	R2/2GC	18-7746	18-7200
<b>MCM110 ALL</b>	1336-2076	7036543	R2/2GC	18-7070	18-7200
<b>MCM 120/2.5L</b>					
2520424 & BELOW	1336-2076	7036543	R2/2GC	18-7746	18-7200
2520425-3377340	1336-3594A1	7036543	R2/2GC	18-7746	18-7200
3377341-3770649	1351-4263A3	7041369	R2/2GC	18-7746	18-7200
3770650-4469865	1351-5202A1	7043182	R2/2GC	18-7746	18-7200
4469866-5192047	1351-6065A2	7044182	R2/2GC	18-7746	18-7200
5192048-6229717	1351-7354A1	17059054	R2/2GC	18-7746	18-7200
6229718 & ABOVE	1351-8480A2	17081060	R2/2GC	18-7746	18-7200
6229718 & ABOVE	1389-8490A2	N/A	M2/Mercarb	18-7097	18-7202
6229718 & ABOVE	1389-9350A2	N/A	M2/Mercarb	18-7097	18-7202
6229718 & ABOVE	1389-9562A1	N/A	M2/Mercarb	18-7098-1	18-7202
<b>MCM 140 /3.0L/3.0LX(4 cyl.)</b>					
2816416 & BELOW	1351-3635A1	7036646	R2/2GC	18-7746	18-7200
2816417-3332137	1351-4032A1	7040080	R2/2GC	18-7746	18-7200
3332138-3771644	1351-4293A1	7040084	R2/2GC	18-7746	18-7200
3771645-5157668	1351-5203A1	7043184	R2/2GC	18-7746	18-7200
5157669-6229717	1351-7355A1	17059052	R2/2GC	18-7746	18-7200
6229718-C856558	1351-8480A2	17081060	R2/2GC	18-7746	18-7200
6229718-C856558	1389-8490A2	N/A	M2/Mercarb	18-7097	18-7202
6229718-C856558	1389-9350A2	N/A	M2/Mercarb	18-7097	18-7202
6229718-C856558	1389-9562A1	N/A	M2/Mercarb	18-7098-1	18-7202
C856559 & ABOVE	1389-815396A2	N/A	M2/Mercarb	18-7098-1	18-7202
C856559 & ABOVE	1389-815397A2	N/A	M2/Mercarb	18-7098-1	18-7202
<b>MCM 140 (6 cyl)</b>					
ALL (BC)	1338-2161	7025638	R1/BC	18-7071	—

① Does not include metering rods

**CARBURETOR KIT/FLOAT APPLICATION (Cont.)**

Model & Serial #	Mercruiser Carb. #	Mfg. Carb. #	Carb. Code & Model	Carb. Kit ①	Float
ALL (B)	1338-2166	7025662	R1/B	18-7071	—
<b>MCM 150</b>					
1823489 & BELOW	1338-2428	7024180	R1/BC	18-7071	—
1823489 & BELOW	1338-2431	7024181	R1/B	18-7071	—
1823490-1830151	1338-2608	7025183	R1/BC	18-7071	—
1823490-1830151	1338-2609	7025184	R1/B	18-7071	—
1830152 & ABOVE	1338-2633	7025188	R2/2GC	18-7070	18-7200
<b>MCM 160</b>					
2492035 & BELOW	1338-2991	7026088	R2/2GC	18-7746	18-7200
2492036 & ABOVE	1351-3635A1	7036646	R2/2GC	18-7746	18-7200
<b>MCM 165 (6 cyl)</b>					
3354701 & BELOW	1351-4282A1	7040083	R2/2GC	18-7746	18-7200
3354702-3774864	1351-4871A1	7042183	R2/2GC	18-7746	18-7200
3774865-5178958	1351-5204A1	7043183	R2/2GC	18-7746	18-7200
5178959 & ABOVE	1351-7356A1	17059050	R2/2GC	18-7746	18-7200
<b>MCM 165/170/3.7L (4 cyl)</b>					
6218037-6916778	1389-8489A5	N/A	M2/Mercarb	18-7097	18-7202
6916779 & ABOVE	1389-9564A1	N/A	M2/Mercarb	18-7098-1	18-7202
<b>MCM 175/4.3L/185 (V-6)</b> (229 CID) ALL	3304-9565A1	N/A	M2/Mercarb	18-7098-1	18-7202
A221455-D714106	3300-8886A2	17083515	R4/4MV	18-7095	18-7201
185 (262 CID)					
A221455-B527954	3304-9353A2	N/A	M2/Mercarb	18-7097	18-7202
<b>MCM 205 (262 CID)</b>	3304-9354A2	—	R4/4MV	18-7095	18-7201
A331455-D714369	3304-9565A1	N/A	M2/Mercarb	18-7098-1	18-7202
<b>MCM/MIE 470 ALL</b>	1376-5990A1	17057132	R2/2GC	18-7076	18-7202
<b>MCM 485 ALL</b>	1376-5990A1	17057132	R2/2GC	18-7076	18-7202
<b>MCM 488 ALL</b>	1347-8460A3	17081299	R4/4ME	18-7077	18-7201
<b>MCM 888</b>					
ALL HOLLEY	1356-4642	D1JJ-9510-8	H2/2300	18-7081	18-7206
ALL ROCHESTER	1376-5659A1	7044185	R2/2GC	18-7075	18-7202
<b>MCM 180/190/3.7LX</b>					
<b>(4 cyl)</b>	1347-9142A2	17083522	R4/4MV	18-7095	18-7201
<b>MIE 198/200/5.0L</b>					
6021383 & BELOW	1376-6491A1	17057139	R2/2GV	18-7075	18-7202
6021384 & ABOVE	1376-8295A3	17080350	R2/2GV	18-7075	18-7202
<b>MCM 200 (6 cyl)</b>					
2494935 & BELOW	1347-3237A2	7037082	R4/4MV	18-7072	18-7201
2494936 & ABOVE	1347-3237A4	7037082	R4/4MV	18-7072	18-7201
<b>MCM 898/200/5.0L</b>					
6218462 & ABOVE	1389-8488A2	N/A	M2/Mercarb	18-7097	18-7202
6218462 & ABOVE	1389-9563A1	N/A	M2/Mercarb	18-7098-1	18-7202
6218462 & ABOVE	1389-9670A2	N/A	M2/Mercarb	18-7098-1	18-7202
<b>MCM 205/4.3LX (V-6 262 CID)</b>					
A331455-D714369	3304-9354A2	17084516	R4/4MV	18-7095	18-7201
<b>MCM/MIE 215 ALL</b>	1356-4066	C9FF-9510-E	H4/4160	18-7096	18-7206
<b>MCM/MIE 225 (FORD)</b>					
ALL	1356-5155	D2JL-9510-C	H4/4160	18-7096	18-7206
<b>MCM/MIE 225 (GM)</b>	1337-2103	7025564	R4/4GC	18-7078	—
1536920-2694014	1337-2604	7025756	R4/4GC	18-7078	—
	1347-3353	7037082	R4/4MV	18-7072	18-7201
	1347-3237A3	7037082	R4/4MV	18-7072	18-7201
<b>MCM 228</b>					
5069430 & BELOW	1347-6427A1	17057282	R4/4MV	18-7072	18-7201
<b>MCM 228TR/ MIE 228</b>					
5069430 & BELOW	1347-6438A1	17057283	R4/4MV	18-7072	18-7201
<b>MCM 228/230/5.0L</b>					
5069431-6021783	1347-7361A1	17059292	R4/4MV	18-7095	
6021784-6218461	1347-8296A4	17080565	R4/4MV	18-7095	18-7201
6218462 & ABOVE	1347-9661A3	—	R4/4MV	18-7095	18-7201
<b>MIE 228</b>					
5067431-6040745	1347-7364A1	17059291	R4/4MV	18-7095	18-7201

① Does not include metering rods

**CARBURETOR KIT/FLOAT APPLICATION (Cont.)**

Model & Serial #	MerCruiser Carb. #	Mfg. Carb. #	Carb. Code & Model	Carb. Kit ①	Float
6040746 & ABOVE	1347-8290A1	17080564	R4/4MV	18-7095	18-7201
<b>MIE 230/5.0L ALL</b>	1347-8290A1	17080564	R4/4MV	18-7095	18-7201
230/5.0LX	1347-9661A3	—	R4/4MV	18-7095	18-7201
<b>MCM/MIE 233</b>					
4465029 & BELOW	1376-5744A1	7044187	R2/2GC	18-7075	18-7202
4465030 & ABOVE	1376-6152A1	17056197	R2/2GC	18-7075	18-7202
<b>MCM/MIE 250 AUTO. CHOKE</b>					
4767999 & BELOW	1347-3353	7037082	R4/4MV	18-7072	18-7201
<b>MCM/MIE 250 (EL. CHOKE)</b>					
4767999 & BELOW	1347-3237A3	7037082	R4/4MV	18-7072	18-7201
<b>MCM 250</b>					
4768000 & ABOVE	1347-6492A1	17057298	R4/4MV	18-7072	18-7201
<b>MCM/MIE 255 (GM)</b>					
4924564 & BELOW	1347-5732A1	7044291	R4/4MV	18-7072	18-7201
4924565-5195908	1347-7062A1	17057295	R4/4MV	18-7072	18-7201
5195909-5907067	1347-7365A1	17059289	R4/4MV	18-7095	18-7201
5907068 & ABOVE	1347-8289A1	17080562	R4/4MV	18-7095	18-7201
<b>MCM/MIE 255 (FORD)</b>					
ALL	1356-5169	D2JL-9510E	H4/4160	18-7096	18-7206
<b>MCM 260/5.7L BRAVO</b>					
5060805 & BELOW	1347-6492A1	17057298	R4/4MV	18-7072	18-7201
5060806-6024393	1347-7362A1	17059288	R4/4MV	18-7095	18-7201
6024394-B525981	1347-8292A4	17080561	R4/4MV	18-7095	18-7201
B525982 & ABOVE	1347-9662A4	—	R4/4MV	18-7095	18-7201
<b>MIE 260/5.7L 350 MAG</b>					
A635178-D617327	1347-8289A1	17080562	R4/4MV	18-7095	18-7201
<b>MIE 5.7 SKI</b>					
A339533-F205099	1347-9415T	17085013	R4/4MV	18-7095	18-7201
<b>MCM/MIE 270 ALL</b>	1347-4180A1	7029285	R4/4MV	18-7072	18-7201
<b>MCM 280</b>					
4176468 & BELOW	1347-4179A2	7040283	R4/4MV	18-7072	18-7201
4176469 & ABOVE	1347-5981A1	7044290	R4/4MV	18-7072	18-7201
<b>MCM 300 MR/TRS (GM)</b>					
6668677 & ABOVE	1347-7498A7	—	R4/4MV	18-7095	18-7201
<b>MCM/MIE 325 AUTO. CHOKE</b>					
3042730 & BELOW	1347-3342	7027080	R4/4MV	18-7072	18-7201
3042731 & ABOVE	1347-4533A1	7041831	R4/4MV	18-7072	18-7201
<b>MCM/MIE 325 EL. CHOKE</b>					
2278747-378099	1347-3689A1	7029280	R4/4MV	18-7072	18-7201
<b>MCM 330/454 MAGNUM (ALPHA ONE)</b>					
5027230 & BELOW	1347-6493A1	17057287	R4/4MV	18-7072	18-7201
5027231-6083144	1347-7363A1	17059290	R4/4MV	18-7095	18-7201
6083145 & ABOVE	1347-8291A3	17080563	R4/4MV	18-7095	18-7201
<b>MIE 330</b>					
5226384 & BELOW	1347-6493A1	17057287	R4/4MV	18-7072	18-7201
5226385 & ABOVE	1347-7366A1	17059287	R4/4MV	18-7095	18-7201
<b>MIE 340/7.4L</b>					
ALL	1347-8288A1	17080560	R4/4MV	18-7095	18-7201
<b>MCM 350 MAGNUM/5.7L BRAVO</b>					
B525992-317327	1347-8289A1	—	R4/4MV	18-7095	18-7201
<b>MIE 350 ALL</b>	1347-5326A2	17065977	R4/4MV	18-7072	18-7201
<b>MCM 370/400 ALL</b>	1347-7498A2	17059280	R4/4MV	18-7095	18-7201
<b>MCM 7.4L (BRAVO ONE)</b>	1347-8291A3	17080563	R4/4MV	18-7095	18-7201
<b>MCM 454 7.4L</b>					
6083145-B816540	—	—	H4/4150, R6647A	18-7728	—
<b>MCM 454 MAGNUM (BRAVO ONE)</b>					
ALL	1347-7498A2	17059280	R4/4MV	18-7095	18-7201
ALL	1347-9863A3	—	R4/4MV	18-7095	18-7201
<b>MCM 502 MAGNUM (BRAVO ONE)</b>					
C878221-D857199	1347-814623A2	—	R4/4MV	18-7095	18-7201
<b>MCM 8.2L</b>	1347-814623A2	—	R4/4MV	18-7095	18-7201

① Does not include metering rods



**18-7228  
FLAME ARRESTOR**  
Replaces: 85784A1,805016A1



**18-7229  
FLAME ARRESTOR**  
Replaces: 85785T, 85785-2



**18-7230  
FLAME ARRESTOR**  
Replaces: 41639A-1, 41639



**18-7231  
FLAME ARRESTOR**  
Replaces: 85785A2



**18-7232  
FLAME ARRESTOR**  
Replaces: 57882, 57882T



**18-7234  
FLAME ARRESTOR**  
Replaces: 805016A1

**ANODIZED ALUMINUM  
FLAME ARRESTOR SPECIFICATIONS**

ENGINE	PART NO.	HEIGHT A	ELEMENT B	THROAT C	VENT TUBES*
4 & 6 cyl.	18-7228	2.156	1.088	3.120	1
4 & 6 cyl.	① 18-7234	2.280	1.550	3.100	0
V-8	18-7229	2.250	1.470	5.050	0
V-8	18-7230	2.250	1.470	5.050	1
V-8	18-7231	2.250	1.470	5.050	2
Hi-Performance	18-7232	2.969	2.190	5.050	2

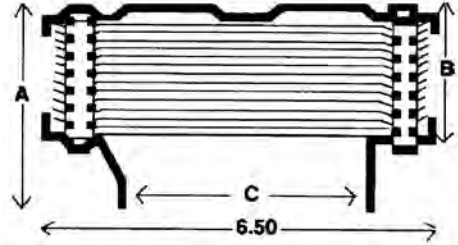

① 7" Outside diameter \* Vent tubes accept 5/8 inch ID hose

**ALL SIERRA FUEL PUMPS INCLUDE MOUNTING GASKET**



**18-8861  
FUEL PUMP W/ COOLER**  
Replaces: 861156A02  
For: GM V-6/ V-8 EFI 0L000000-0M299999



**18-8862  
FUEL PUMP W/ COOLER**  
Replaces: 861156A03  
For: GM V-6/ V-8 EFI 0M300000



**18-8863  
FUEL PUMP W/ COOLER**  
Replaces: 861156A04  
For: GM V-6/ V-8 engines with cool fuel 0K999999 & below



**18-8864  
FUEL PUMP W/ REGULATOR**  
Replaces: 866169T01  
For: Gm V-8 with Gen III Cool Fuel Module-high pressure



**18-8865  
FUEL PUMP**  
Replaces: 866170A01  
For: Gm V-8 with Gen III Cool Fuel Module-low pressure



**18-8867  
FUEL PUMP**  
Replaces: 861155A6  
For: 4.3L V-6





**18-8868**  
**FUEL PUMP**  
Replaces: 861155A3  
For: 5.0/ 5.7L V-8



**18-8860**  
**FUEL PUMP**  
Replaces: 861677T  
For: GM V-8 (454 & 502) applications



**18-7256**  
**FUEL PUMP**  
Flange I.D. # 6790,M3530  
Replaces: 32722  
For: GM (4 & 6 Cyl.)153, 230, 250, 292



**18-7266**  
**FUEL PUMP**  
Flange I.D. # 41413, M6696  
For: Ford (V-8) 302, 351



**18-7267**  
**FUEL PUMP**  
Flange I.D. # 41414  
Replaces: 62092,T  
For Ford (V-8) 302



**18-7274**  
**FUEL PUMP**  
Flange I.D. # 41421, M73021  
Replaces: 86246  
For: GM (V-8) 305, 350, 400, 228 / 250 / 255 / 260 / 280



**18-7275**  
**FUEL PUMP**  
Flange I.D. # 41422  
Replaces: 86247,T  
For: GM (V-8) 454, 330 / 325 / 350 / 390



**18-7278**  
**FUEL PUMP**  
Flange I.D. # M60032  
Replaces: 86234A4, 86234A05  
For: GM (4 & 6 Cyl.) 153, 181, 225, 250, 120 / 140 / 160 / 165 / 470 / 485 / 488



**18-7282**  
**FUEL PUMP**  
Flange I.D. # M60337  
Replaces: 42725A3  
For: GM (V-6) 225, 170 / 180 / 190



**18-7283**  
**FUEL PUMP**  
Flange I.D. # M60600  
Replaces: 97401A2, 97401A2A8, 861678A1  
For: GM (V-8) 305, 350, 228 / 230 / 260 / 898



**18-7284**  
**FUEL PUMP**  
Flange I.D. # M60315  
Replaces: 41141A2,862077A1  
For: GM (V-6) 231, 262, 229



**18-7288-1**  
**FUEL PUMP**  
Flange I.D. #60601  
Replaces: 812454A1, 862048A1  
For: Inline (4 cyl) 120, 140, 3.0L and 224 CID 7.4L / 454 / 420 / 330



**18-7326**  
**ELECTRIC FUEL PUMP**  
Replaces: 805656A2  
For: 1992-93, 1996  
F.I. & Carbureted 4.3L  
with inline electric pump

APPLICATION ON NEXT PAGE

## FUEL PUMP APPLICATION

Model	CID / # CYL	Year Range	Beginning Serial Number	Ending Serial Number	Fuel Pump #1	Fuel Pump #2	Pump Filter
120	153/L4	1964-1972	1666601	3377340	18-7278 ①	—	18-7860
120	153/L4	1964-1972	1666601	3377340	18-7256 ②	—	—
120	153/L4	1972-1982	3377341	6229717	18-7278	—	18-7860
120	153/L4	1983-1986	6229718	B531853	18-7278 ③	—	18-7860
120			4469866	& Below	18-7278	—	—
120			4469866	4952700	18-7278	—	—
120			4952701	& Up	18-7278	—	—
120			5192049	6229717	18-7278	—	—
120/2.5L			6229718	& Up	18-7278	—	—
120/2.5L			6229718	& Up	18-7282	—	—
2.5L	153/L4	1987-1989	B531854	BC853255	18-7278 ④	—	18-7860
140 (4 CYL)	181/L4	1968-1982	2508261	6229717	18-7278	—	18-7860
140 (4 CYL)	181/L4	1983-1986	6229718	B450800	18-7278 ⑤	—	18-7860
3.0L	181/L4	1987-1989	B450801	C856558	18-7278 ⑥	—	18-7860
140			4460664 & Below	& Below	18-7278	—	—
140			4460665	4918569	18-7278	—	—
140			4918570	& Up	18-7278	—	—
140 (4 Cyl.)			5157669	6229717	18-7278	—	—
140/3.0L			6229717 & Below	& Below	18-7278	—	—
140/3.0L			6229718 & Up	& Up	18-7282	—	—
3.0L/3.0LX			C856559 & Up	& Up	18-7282	—	—
140 (6 Cyl.)			1538930	1725960	18-7256	—	—
150			1666495	2048046	18-7256	—	—
160			2048022	2770031	18-7278	—	—
165			4471566	4884834	18-7278	—	—
165			5178959 & Up	& Up	18-7278	—	—
165/3.7L (4 Cyl.)			6916779 & Up	& Up	18-7282	—	—
180/3.7-LX (4 Cyl.)			6916779 & Up	& Up	18-7282	—	—
175/4.3L (262 CID)			B527955 & Up	& Up	18-7284	—	—
185 (229 CID)			6330183 & Up	& Up	18-7284	—	—
185 (262 CID)			A331455 & Up	& Up	18-7284	—	—
470	224/L4	1976-1984	4208730	6916778	18-7278	—	18-7860
485	224/L4	1980-1982	5685394	6218036	18-7278	—	18-7860
488	224/L4	1983-1984	6170297	6916778	18-7278 ⑦	—	18-7860
140 (6 CYL)	194/L6	1963	1538930	1725960	18-7256	—	—
150	230/L6	1964-1966	1666495	2048046	18-7256	—	—
160	250/L6	1967-1969	2048022	2770031	18-7278 ⑧	—	18-7860
160	250/L6	1967-1969	2048022	2770031	18-7256 ⑨	—	—
165 (6 CYL)	250/L6	1979-1981	2770032	5813433	18-7278	—	18-7860
200 (6 CYL)	250/L6	1969	2453769	2712072	18-7278	—	18-7860
200 GM			6218462	& Up	18-7283	—	—
200/5.0L GM			B525982	& Up	18-7283	—	—
185 (4bbl)	229/V-6	1983-1984	6330183	6919655	18-7284	—	—
175	262/V-6	1987	B527955	B773242	18-7284	—	—
185 (2bbl)	262/V-6	1985-1986	A331455	B527954	18-7284	—	—
205	262/V-6	1985-1987	A331455	B775129	18-7284	—	—
205/4.3L-LX (262 CID)			B527955	& Up	18-7284	—	—
262 MAG EFI (GEN +)	262/V-6	1996-1997	F803800	K999999	18-8867	—	—
4.3L	262/V-6	1988-1992	B773243	D714106	18-7284	—	—
4.3L (GEN II)	262/V-6	1992-1996	D714107	F802999	18-8867	—	—
4.3L (GEN +)	262/V-6	1998-2010	L012009	& Up	18-8868	—	—
4.3L EFI (GEN +)	262/V-6	1998-2001	L012009	M299999	18-8861 ⑩	—	—
4.3L MPI	262/V-6	2002-2010	M300000	& Up	18-8862 ⑪	—	—
4.3LH (GEN+)	262/V-6	1998-2002	L010044	M614999	18-8868	—	—
4.3LX	262/V-6	1988-1992	B775130	D714369	18-7284	—	—
4.3LX (GEN II)	262/V-6	1992-1996	D714107	F802999	18-8867	—	—
4.3LX (GEN +)	262/V-6	1996-1997	F803000	K999999	18-8867	—	—
4.3LXH (GEN +)	262/V-6	1996-1997	F803114	K999999	18-8867	—	—
215 (FORD)	302/V-8	1970-1972	2781153	3563181	18-7267	—	—
215 Ford			3085036	& Below	18-7267	—	—
215 Ford			3258182	& Up	18-7267	—	—
225 Ford	302/V-8	1973-1974	3385721	4166999	18-7267	—	—
228 MCM & MIE	305/V-8	1977-1978	4765100	5170008	18-7274	—	—
228 MCM & MIE	305/V-8	1979-1982	5170009	6218461	18-7274	—	—
228 MCM & MIE	305/V-8	1979-1982	5170009	6218461	18-7283 ⑫	—	—
888 (FORD)	302/V-8	1971-1977	3108723	4887829	18-7267	—	—
228	305/V-8	1982-1984	6218462	6899268	18-7283	—	—
230 MIE	305/V-8	1981-1987	5907058	B788151	18-7283	—	—
230/5.0L-GM (IB)			B522506	& Up	18-7283	—	—
230 GM			6218462	& Up	18-7283	—	—
230/5.0L-LX GM			B525982	& Up	18-7283	—	—
230	305/V-8	1985-1987	6899269	B773739	18-7283	—	—
5.0L	305/V-8	1988-1995	B774445	F600999	18-7283	—	—
5.0L (GEN +)	305/V-8	1998-2010	L015751	& Up	18-8868	—	—
5.0L EFI (GEN +)	305/V-8	1998-2001	L012052	M299999	18-8861 ⑬	—	—
5.0L MIE	305/V-8	1988	B788152	C396832	18-7283	—	—
5.0L MPI ALPHA	305/V-8	2002-2010	M300000	& Up	18-8862 ⑭, ⑮	18-8868 ⑯	—
5.0L MPI BRAVO	305/V-8	2002-2004	M300000	W059999	18-8862 ⑰, ⑱	18-8868 ⑲	—
5.0L MPI BRAVO	305/V-8	2004-2010	W060000	& Up	18-8864 ⑲	18-8865 ⑳	—
5.0LX	305/V-8	1988-1995	B773740	F600999	18-7283	—	—
898	305/V-8	1977-1982	4762210	6218461	18-7274 ㉑	—	—
898	305/V-8	1977-1982	4762210	6218461	18-7283 ㉒	—	—
898	305/V-8	1983-1984	6218462	6899057	18-7283	—	—
233 FORD			4500860	& Up	18-7267	—	—
250	350/V-8	1977	4768000	4908849	18-7274	—	—
255	350/V-8	1975-1976	4175500	4767999	18-7274	—	—
255 MIE (GM)	350/V-8	1975-1980	4175500	5907057	18-7274	—	—
255 FORD			3258728	& Up	18-7267	—	—
255 GM			5195909	& Up	18-7274	—	—
260	350/V-8	1978-1982	4908850	6218461	18-7274 ㉓	—	—
260	350/V-8	1978-1982	4908850	6218461	18-7283 ㉔	—	—
260	350/V-8	1983-1987	6218461	& Up	18-7283	—	—
260 MIE	350/V-8	1981-1987	5907058	B788151	18-7283	—	—

- ① low pressure lift pump
- ② high pressure fuel cool pump
- ③ fuel pump mounted with filter bowl facing up
- ④ fuel pump mounted with filter bowl facing down
- ⑤ AC fuel pump
- ⑥ Carter fuel pump
- ⑦ mechanical fuel pump
- ⑧ use if fuel pump has sight glass
- ⑨ use if fuel pump has sight tube
- ⑩ fuel pump/cooler kit



## FUEL PUMP APPLICATION

Model	CID / # CYL	Year Range	Beginning Serial Number	Ending Serial Number	Fuel Pump #1	Fuel Pump #2	Pump Filter
450	454/V-8	1995-1996	F347100	F347277	18-8860	—	—
454 MAG ALPHA	454/V-8	1986-1988	A631894	B785148	18-7288-1	—	—
454 MAG BRAVO GM			B840126	& Up	18-7288-1	—	—
454 MAG BRAVO	454/V-8	1988-1992	A631894	B785148	18-7288-1	—	—
454 MAG BRAVO	454/V-8	1992-1997	D805069	K999999	18-8860	—	—
454 MAG EFI	454/V-8	1994-1996	F115700	F802349	18-8860	—	—
454 MAG EFI SKI	454/V-8	1995-1996	F215800	F820099	18-8860	—	—
454 MAG MPI	454/V-8	1996	F802350	K147349	18-8860	—	—
454 MAG MPI	454/V-8	1997	K147350	K999999	18-8861	Ⓜ	—
454 MAG MPI	454/V-8	1998-2001	L010029	M024999	18-8861	Ⓜ	—
454 MAG MPI HORIZON MIE	454/V-8	1998-2001	L002200	L674000	18-8861	Ⓜ	—
454 MAG MPI SKI	454/V-8	1996-1997	F820100	K999999	18-8860	—	—
470			5097479	& Below	18-7278	—	—
470			5097480	& Up	18-7278	—	—
470			5520115	6218036	18-7278	—	—
470			6218037	& Up	18-7278	—	—
485			5685394	& Up	18-7278	—	—
488			6170297	& Up	18-7278	—	—
525SC	454/V-8	1992-1999	D725809	L415623	18-8860	—	—
7.4L BRAVO	454/V-8	1988-1991	B771113	D603117	18-7288-1	—	—
7.4L BRAVO	454/V-8	1992-1997	D603118	K999999	18-8860	—	—
7.4L EFI MIE	454/V-8	1996-1997	F874815	K999999	18-8863	Ⓜ	—
7.4L MIE	454/V-8	1988-1992	B788366	D715493	18-7288-1	—	—
7.4L MIE	454/V-8	1992-1997	D715494	K999999	18-8860	—	—
7.4L MPI	454/V-8	1998-2001	L010003	M024330	18-8861	Ⓜ	—
7.4L MPI MIE	454/V-8	1995-1997	F563052	K147349	18-8860	—	—
7.4L MPI MIE	454/V-8	1997	K147350	K999999	18-8863	Ⓜ	—
7.4L MPI MIE	454/V-8	1997-2001	L002006	L674613	18-8861	Ⓜ	—
7.4LX BRAVO EFI	454/V-8	1996-1997	F820000	K999999	18-8863	Ⓜ	—
7.4LX BRAVO MPI	454/V-8	1996-1997	F602010	K999999	18-8860	—	—
7.4L W/HURTH (IB)			C391564	& Up	18-7288-1	—	—
390	482/V-8	1969-1970	2781129	2825059	18-7275	—	—
496 MAG & HO	496/V-8	2001-2004	M025000	W059999	18-8862	Ⓜ, Ⓜ	18-8868 Ⓜ
496 MAG & HO	496/V-8	2004-2010	W060000	& Up	18-8864	Ⓜ	18-8865 Ⓜ
8.1S MPI MIE & HO	496/V-8	2001-2004	M026000	W089999	18-8862	Ⓜ, Ⓜ	18-8868 Ⓜ
8.1S MPI MIE & HO	496/V-8	2004-2010	W090000	& Up	18-8864	Ⓜ	18-8865 Ⓜ
465	502/V-8	1992-1994	D456155	F213244	18-7275	—	—
500	502/V-8	1994-1998	F213293	L001772	18-7275	—	—
502 MAG BRAVO	502/V-8	1992-1993	D824589	F114528	18-8860	—	—
502 MAG EFI	502/V-8	1993-1995	D840650	F802599	18-8860	—	—
502 MAG MPI	502/V-8	1996	F802600	K147349	18-8860	—	—
502 MAG MPI	502/V-8	1997	K147350	K999999	18-8863	Ⓜ	—
502 MAG MPI	502/V-8	1998-2001	L017000	M024999	18-8861	Ⓜ	—
600SC	502/V-8	1992-2000	D725676	L601186	18-8860	—	—
8.2L MAG & HO	502/V-8	2010	A340340	& Up	18-8864	Ⓜ	18-8865 Ⓜ
8.2L MAG & HO MIE	502/V-8	2010	A350802	& Up	18-8864	Ⓜ	18-8865 Ⓜ
8.2L MIE	502/V-8	1993-1996	D857200	F819619	18-8860	—	—
8.2L MPI MIE	502/V-8	1996-1997	F819620	K147349	18-8860	—	—
8.2L MPI MIE	502/V-8	1997	K147350	K999999	18-8863	Ⓜ	—
8.2L MPI MIE	502/V-8	1998-2001	L002450	L674200	18-8861	Ⓜ	—

- |  |                                    |
|--|------------------------------------|
| Ⓜ low pressure lift pump                         | Ⓜ Carter fuel pump                 |
| Ⓜ high pressure fuel cool pump                   | Ⓜ mechanical fuel pump             |
| Ⓜ fuel pump mounted with filter bowl facing up   | Ⓜ use if fuel pump has sight glass |
| Ⓜ fuel pump mounted with filter bowl facing down | Ⓜ use if fuel pump has sight tube  |
| Ⓜ AC fuel pump                                   | Ⓜ fuel pump/cooler kit             |

## FUEL WATER SEPARATORS

Sierra fuel water separators remove over 99.8% of emulsified water from your gasoline. Sierra's 10 micron filters are over 90% efficient at removing particles as small as 10 micron. All filters flow @ 90 GPH to feed even the hungriest motor. Sierra 10 micron filters are recommended to prevent damage to sensitive inboard and outboard fuel injection systems.

- UNIVERSAL DESIGN -  
**DIRECT REPLACEMENT FOR MERCURY AND YAMAHA  
 FUEL WATER SEPARATOR BRACKETS**



Bracket Type	Part #	Replaces	Bracket Type	Part #	Replaces
1/4" Stainless Steel	18-7777		1/4" Aluminum	18-7853-1	Mercury 89876A3
3/8" Stainless Steel	18-7776		3/8" Aluminum	18-7775	

# FUEL WATER SEPARATOR KITS



## 21 MICRON FILTER KITS - FOR CARBURETED ENGINES

Kit Type	Part #	Micron Rating	Contents	Replaces
1/4" Aluminum (Short Filter)	18-7848-1	21	1 - 18-7844 filter & 1 18-7853-1 bracket 2 - 18-4256 1/4" pipe plugs	Mercury - 35-802893A4, Q4, 35-60494A4
1/4" Aluminum Bonus Pack <b>Contains spare filter</b>	18-7848-2	21	2 - 18-7844 filter & 1 18-7853-1 bracket 2 - 18-4256 1/4" pipe plugs	
1/4" Aluminum (Tall Filter)	18-7852-1	21	1 - 18-7845 filter & 1 18-7853-1 bracket 2 - 18-4256 1/4" pipe plugs	
1/4" Aluminum Bonus Pack <b>Contains spare filter</b>	18-7852-2	21	2 - 18-7845 filter & 1 18-7853-1 bracket 2 - 18-4256 1/4" pipe plugs	
3/8" Aluminum (Tall Filter)	18-7775-1	21	1 - 18-7845 filter & 1 18-7775 bracket 2 - 18-4264 3/8" pipe plugs	
1/4" Stainless Steel (Tall Filter)	18-7777-1	21	1 - 18-7845 filter & 1 18-7777 bracket 2 - 18-4256 1/4" pipe plugs	
3/8" Stainless Steel (Tall Filter)	18-7776-1	21	1 - 18-7845 filter & 1 18-7776 bracket 2 - 18-4264 3/8" pipe plugs	



## 10 MICRON FILTER KITS FOR FUEL INJECTED ENGINES

Kit Type	Part #	Micron Rating	Contents
1/4" Aluminum (Short Filter)	18-7983-1	10	1 - 18-7944 filter & 1 18-7853-1 bracket 2 - 18-4256 1/4" pipe plugs
1/4" Aluminum Bonus Pack <b>Contains spare filter</b>	18-7983-2	10	2 - 18-7944 filter & 1 18-7853-1 bracket 2 - 18-4256 1/4" pipe plugs
1/4" Aluminum (Tall Filter)	18-7982-1	10	1 - 18-7945 filter & 1 18-7853-1 bracket 2 - 18-4256 1/4" pipe plugs
1/4" Aluminum Bonus Pack <b>Contains spare filter</b>	18-7982-2	10	2 - 18-7945 filter & 1 18-7853-1 bracket 2 - 18-4256 1/4" pipe plugs
1/4" Aluminum (High Capacity Filter)	18-7966-1	10	1 - 18-7866 filter & 1 18-7853-1 bracket 2 - 18-4256 1/4" pipe plugs
3/8" Aluminum (Tall Filter)	18-7986-1	10	1 - 18-7945 filter & 1 18-7775 bracket 2 - 18-4264 3/8" pipe plugs
1/4" Stainless Steel (Tall Filter)	18-7984-1	10	1 - 18-7945 filter & 1 18-7777 bracket 2 - 18-4256 1/4" pipe plugs
3/8" Stainless Steel (Tall Filter)	18-7985-1	10	1 - 18-7945 filter & 1 18-7776 bracket 2 - 18-4264 3/8" pipe plugs



**10 MICRON FILTER KITS WITH DRAIN BOWLS**

Sierra AquaVue™ and metal bowl separator filters allow water to be drained from the filter to extend service life. Use the AquaVue™ bowl for outboard, above deck installations. USCG regulations require the use of the flame resistant metal bowl below deck.

Kit Type	Part #	Micron Rating	Contents
1/4" Aluminum w/ metal drain bowl	18-7951	10	1 - 18-7919 filter & 1 18-7853-1 bracket 1 - 18-7924 metal bowl 2 - 18-4256 1/4" pipe plugs
1/4" Stainless Steel w/ metal drain bowl	18-7938	10	1 - 18-7919 filter & 1 18-7777 bracket 1 - 18-7924 metal bowl 2 - 18-4256 1/4" pipe plugs

**COMPACT BRACKET AND SEPARATOR KIT - FOR SMALL OUTBOARDS AND FRESH WATER APPLICATIONS**

18-7774  
COMPACT ALUMINUM BRACKET



18-7965-1  
10 MICRON COMPACT SEPARATOR KIT  
Contains:  
1 - 18-7774 bracket  
1 - 18-7865 filter



**REPLACEMENT FILTERS**



**UNIVERSAL DESIGN - DIRECT REPLACEMENT FOR MERCURY**

10 MICRON REPLACEMENT FILTERS			21 MICRON REPLACEMENT FILTERS		
Part #	Description	Replaces	Part #	Description	Replaces
18-7944	Short - 3.875"	Mercury - 35-807172, 35-802893Q	18-7844	Short - 3.875"	Mercury - 35-807172, 35-802893Q
18-7945	Long - 4.35"	Mercury - 35-802893Q			
18-7866	High Capacity - 6"		18-7845	Long - 4.35"	Mercury - 35-802893Q
18-7865	Compact 10 Micron				



**10 Micron replacement filters and kits with drain bowls**

REPLACEMENT FILTERS			REPLACEMENT BOWLS	
Part #	Description	Replaces	Part #	Description
18-7919	Spin on replacement	35-809097 Racor S3213	18-7924	Metal Collection Bowl
18-7920	Spin on replacement	Mercury 35-809099 Racor S3214	<b>FILTER &amp; BOWL KITS</b>	
18-7947	Spin on replacement	Racor S3240	Part #	Description
18-7948	Spin on replacement Fits - 320RRAC01	35-886638 Racor S3227	18-7929	Filter & Metal Bowl Mercury Style Contains: 18-7919 filter, 18-7924 bowl
18-7949	Spin on replacement Fits - 660RRAC02	Racor S3232	18-7943	Filter & Metal Bowl Contains: 18-7920 filter, 18-7924 bowl
			18-7969	Filter & Metal bowl Contains: 18-7948 filter, 18-7924 bowl



**18-7919**  
**FUEL/WATER SEPARATING FILTER**  
 Replaces: Mercuriser 35-809097 and Racor™ S3213  
 For styles with spin on drain bowls.



**18-7784**  
**FUEL FILTER**  
 Replaces:  
 Mercuriser 35-11004A1, 35-803897Q1  
 For: 2.5L/3.0L(6229718 & later), All MC224 CID (6218037 & later), All GM 262 CID (A331455 & later) with Carter Fuel Pumps



**18-7977**  
**"GEN III COOL FUEL SYSTEM" FUEL FILTER**  
 Replaces: 35-866171A01  
 For: 350 Mag MPI Alpha/Bravo, 350 Mag MPI Horizon Alpha/Bravo, 350 Mag MPI Horizon MIE, 350 Mag MPI MIE, 496 MAG, 496 MAG H.O., 5.0 MPI Alpha/Bravo, 8.1L Inboard, 8.1L Inboard H.O., MX 6.2L MPI Alpha/Bravo, MX 6.2L MPI Horizon Alpha/Bravo, MX 6.2L MPI Horizon MIE, MX 6.2L MPI MIE



**18-7964**  
**TRANSMISSION FILTER KIT**  
 Replaces: 35-815419, 8791014241  
 For: Mercuriser V-8 Inboard with Hurth Transmission



**18-7855**  
**FUEL FILTER**  
 Replaces: 1397-2150



**18-7717**  
**FILTER ELEMENT**  
 Replaces: 35-93568  
 For: Rochester 2 bbl & 4 bbl Carburetors



**18-7859**  
**FUEL FILTER**  
 Replaces: 35-53336, 3302-9033, 35-53336Q  
 For: Most GM Inline 4 & 6 cycle, Ford & Gm V-8's up to 400 HP and all Mercuriser 224 CID



**18-7721**  
**FUEL FILTER**  
 Replaces: 35-864572  
 All MPI & EFI engines with boost pump, 8.1L & 496cid, for 3/8" ID fuel lines



**18-7860**  
**FUEL FILTER**  
 Replaces: 35-49088A2, 35-49088Q2  
 (Used in 18-7278 Fuel Pump)  
 For: Inline 4 & 6 cycle engines



**18-7869**  
**FUEL FILTER**  
 Replaces:  
 1397-8767, 1397-8545  
 For:

Model/HP	Serial #	Model/HP	Serial #
GM 2.5L/3.0L	6229718 & later	330 HP	6083145 & later
GM 5.0L/5.7L	6218462 & later	GM 255	590768 & later
All 205	A331455 & later	5.7L SKI 340,230	ALL
228 HP	6021784 & later	& 260 Inboards	



**18-7873**  
**FUEL FILTER**  
 Replaces: 35-808275  
 For: Models D7.3/270 Bravo & MIE Diesel Engines 1994-96



**18-79901**  
**VST FILTER**  
 Replaces: 66L-13915-00-00  
 Fits: 454 EFI(GenV) GM 1994-96  
 454 EFI (SKI)(Gen V) GM 1995  
 454 Mag Bravo MPI (Gen VI) GM 1996-97  
 454 Mag MPI (SKI)(Gen VI) GM 1996-97  
 502 EFI (Gen V) GM 1993-95  
 502 Mag MPI (Gen VI) GM 1996  
 7.4L MIE MPI (LH) Gen V GM 1995-96  
 7.4L MIE MPI (LH) Gen VI GM 1996-97  
 7.4LX Bravo MPI (Gen V) GM 1996  
 7.4LX Bravo MPI (Gen VI) GM 1996-97  
 8.2L MIE MPI (LH) Gen VI GM 1996-97



**18-2641**  
**VAPOR SEPARATOR TANK O-RING**  
 Replaces: 808500



**18-6457  
COMPOSITE PULLEY**  
Replaces: 807757T  
3" OD Serpentine for 13/16"  
width belt,  
For Late model GM V6 & V8 engines



**18-3506  
CIRCULATING PUMP**  
Replaces: 46-879194401  
For: V6 MCM SN: 1A063240 (2007)  
- CURRENT



**18-3593  
WATER PUMP**  
Replaces: 884727  
Late Model 4 cyl GM engines requiring  
hose fitting



**18-3574  
CIRCULATING WATER PUMP**  
Big block GM engines with composite  
timing covers  
"Late Model" includes 482 and 502 CID  
Replaces: 850454, 8504541



**18-3575  
CIRCULATING WATER PUMP  
(Bi-Directional)**  
Replaces: 65142A1  
For: GM Inline (4 & 6 Cyl.)



**18-3577  
CIRCULATING  
WATER PUMP  
(Bi-Directional)**  
Replaces: 67859, 17670,  
811573,8504541  
For: Big block GM engines with stamped  
steel timing covers



**18-3573  
CIRCULATING  
WATER PUMP**  
All 8.1L big-block GM engines  
Replaces: 883925  
For engines with composite timing cover



**18-3583  
CIRCULATING WATER  
PUMP  
(Bi-Directional)**  
Replaces: 60658, 8503991,  
17437  
For: GM V-6 & V-8 engines with stamped  
steel timing covers.



**18-3584  
CIRCULATING WATER PUMP**  
Replaces: Mercruiser 71683A1, 883885  
Mercruiser 215 to 255 & 888  
For: Ford small block V-8 engines.



**18-3599  
CIRCULATING WATER PUMP**  
Replaces: Mercruiser 811841,  
850399, 8503991  
For late model GM V-6 & V-8 engines using a composite  
timing cover



**18-3007  
18-3007-10<sup>①</sup>  
IMPELLER**  
Replaces: 47-89983, 4789983T  
For 60 HP



**18-3016-1  
IMPELLER KIT**  
with gasket  
Replaces: 47-862232A2  
For: Late-model Bravo & High Performance. Includes  
350 Mag., 4.3L., 496 Mag., 5.0L., 8.1S and MX 6.2L



**18-3017  
18-3017-10<sup>①</sup>  
IMPELLER**  
Replaces: 47-89984, 47-89984T4,  
47-30221, 47-65960  
For all #1, R, MR, Alpha Units thru S/N D494568.  
Also for raw water pump on: 190 IB S/N 1564539-1720903  
225 IB S/N 1539620-2278646



**18-3056  
18-3056-10<sup>①</sup>  
IMPELLER**  
Replaces: 47-43026-2  
For Alpha I-Generation 2  
S/N D494569 & Above  
Mercuriser Vazer



**18-3087  
IMPELLER**  
Replaces: 47-59362, 47-59362T





















**18-3109  
WATER TUBE GUIDE**  
Replaces: 23-29804, 23-29804T  
(used with 18-3116 Housing)

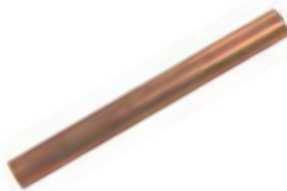
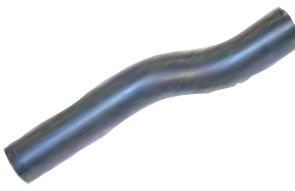

**18-3110  
WATER PUMP  
HOUSING BUSHING**  
Replaces: 26-38970  
(Part of 18-3116 Housing)

① Discount shop pack of 10 - Priced per package



 <p><b>18-3114 INSERT CUP</b> Replaces: 48752, 48752T (Part of 18-3116 Housing)</p>	 <p><b>18-3117 IMPELLER PLATE</b> Replaces: 32435 For #1 Units thru S/N D494568</p>	 <p><b>18-3122 IMPELLER PLATE</b> Replaces: 817276, 8172761 For Alpha I - Generation 2 S/N D494569 &amp; Above</p>		
 <p><b>18-3350 WEAR PLATE</b> Replaces: 94576</p>	 <p><b>18-3351 WEAR PLATE</b> Replaces: 94916</p>	 <p><b>18-3293 IMPELLER KEY</b> Replaces: 28-43037</p>		
 <p><b>18-3151 COUPLING</b> Replaces: 816597</p>	 <p><b>18-3417 WATER PUMP BASE</b> Replaces: 46-57234A1</p>	 <p><b>18-3420 WATER PUMP BASE</b> Replaces: 46-44292A3</p>		
 <p><b>18-3421 WATER PUMP BASE</b> Replaces: 46-48748A1</p>	 <p><b>18-3116 WATER PUMP HOUSING</b> Replaces: 46-96148A1</p>	<p>PKG. OF 2</p>  <p><b>18-2732 18-2732-9① WATER SHUTTER</b> Replaces: 807166A3</p>		
 <p><b>18-2733 WATER SHUTTER</b> Replaces: 99370A2</p>	 <p><b>18-2727 EXHAUST WATER SHUTTER</b> Replaces: 60930</p>	 <p><b>18-3220 WATER TUBE</b> Replaces: 32-54236 For #1 -R/MR/Alpha</p>	 <p><b>18-3221 WATER TUBE</b> Replaces: 32-860220 For Gen II</p>	
 <p><b>18-3222 WATER TUBE GUIDE</b> Replaces: 23-816583 For Gen II</p>	<p>PKG. OF 5</p>  <p><b>18-3226 18-3226-9① IMPELLER PUMP SCREW</b> Replaces: 10-30720 For R units</p>	<p>PKG. OF 5</p>  <p><b>18-3227 18-3227-9① WATER PUMP DOWEL PIN</b> Replaces: 17-35973 For R/MR, Alpha I</p>	<p>PKG. OF 5</p>  <p><b>18-3229 18-3229-9① WATER POCKET SCREW</b> Replaces: 10-28668 For MR/Alpha</p>	 <p><b>18-3197 SCREW</b> Replaces: 10-76156</p>

① Priced per Package

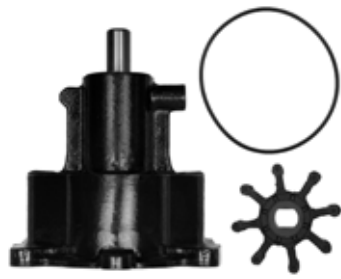

**18-3160**  
**SEA WATER PUMP, BRASS**  
 Replaces: 46-862914A13



**18-3600**  
**SEA WATER PUMP**  
 Replaces: 46-72774A32  
 Fits: V8 Engines w/ith V-Belt and 2 piece pump



**18-3155**  
**WATER PUMP REPAIR KIT**  
 Replaces: 47-72774A89  
 Fits: Bravo Seawater Pump with 2 piece housing



**18-3216**  
**IMPELLER KIT**  
 Replaces: 47-59362A4  
 Fits: 1996-97 7.4L MIE MPI(LH) Gen VI GM 454 V8, 1996-97, 7.4L TBI MIE(LH) Gen VI GM 454 V8, 1996-97 8.2L MIE MPI(LH) Gen VI GM 502 V8.



**18-3318**  
**WATER PUMP KIT**  
 Replaces: 47-59362Q08  
 Fits: Plastic 1 and 2 piece sea water pump body



**18-3237**  
**IMPELLER REPAIR KIT**  
 For: Bravo I, II, III (1988 & up) B664190 & up Fits Bravo drives with 1 piece housing

—CONTAINS —

Part #	Desc.	O.E. #	Qty.
18-3087	Impeller	47-59362	1
18-3350	Wear Plate	94576	1
18-7163	O-Ring	25-33465	



**18-3214**  
**IMPELLER REPAIR KIT**  
 Replaces: 47-43026T6, T8, T11  
 For Alpha I - Generation II  
 S/N D494569 & Above  
 Mercruiser Vazer

① **18-3214D**

—CONTAINS —

Part #	Desc.	O.E. #	Qty.
18-2564	Impeller Gasket	22-43033-1, 27-43033-1	1
18-2565	Impeller Gasket	27-43047-1	1
18-2566	Impeller Gasket	27-812777	1
18-2944	Seal Ring	12-19183	1
18-3056	Impeller	47-43026-1, 47-43026-2	1
18-3122	Impeller Plate	812726	4
18-7420	O-Ring	25-21836	1



**18-3217**  
**IMPELLER KIT**  
 For #1 Units thru S/N D494568  
 (Similar to #46-96148A5 without base or housing)

① **18-3217D**

—CONTAINS —

Part #	Desc.	O.E. #	Qty.
18-3109	Water Tube	23-29804	1
18-3017	Impeller	47-89984	1
18-2919	Water Pump Base to Gear Housing Gasket	27-42631-1	1
18-3110	Grommet	26-38970	1
18-2945	Gear Housing Drain Screw Gasket	12-19183	2
18-2826	Water Pump Base to Gear Housing Gasket	27-85610-1	1
18-2914	Lower Water Pump to Wear Plate Gasket	27-85608-1	1
18-2915	Upper Water Pump to Wear Plate Gasket	27-85609-1	1
18-2944	Seal Ring	26-45577	1
18-3117	Plate	32435	1
18-7158	O-Ring	25-30613	1
18-7162	O-Ring	25-33145	1
18-7173	O-Ring	25-30224	1
18-7176	O-Ring	25-90011	1
18-2801	Water Pump Gasket	27-32438	1
18-7196	O-Ring	25-38099	1
18-7426	O-Ring	35-30271	1



**18-3150**  
**WATER PUMP KIT**  
 Replaces: 46-807151A14  
 For: Bravo

① **18-3309D**

**18-3309**  
**WATER PUMP KIT**  
 For: Bravo

—CONTAINS —

Part #	Desc.	O.E. #	Qty.
18-3350	Wear Plate	94576	1
18-3351	Wear Plate	94916	1
18-3087	Impeller	47-59362	1
18-0386	Body Gasket	27-94914	2
18-0916	Water Pump Gasket	27-805215-1	1



**18-3147**  
**WATER PUMP KIT**  
 Replaces: 81275T4  
 For: Gen II-Lower  
 s/n D469859 and Up

① Items ending in "D" are Display Packaged - Regular number is Non-Display

—CONTAINS —

Part #	Desc.	O.E. #	Qty.
18-3109	Water Tube	23-29804	1
18-3017	Impeller	47-89984	1
18-3116	Housing	46-96148A1	1
18-2919	Water Pump Base to Gear Housing Gasket	27-42631-1	1
18-3110	Grommet	26-38970	1
18-2945	Gear Housing Drain Screw Gasket	26-20260, 12-19183	2
18-2826	Water Pump Base to Gear Housing Gasket	27-85610-1	1
18-2914	Lower Water Pump to Wear Plate Gasket	27-85608-1	1
18-2915	Upper Water Pump to Wear Plate Gasket	27-85609-1	1
18-2944	Seal Ring	26-45577	1
18-3117	Plate	32435	1
18-7158	O-Ring	25-30613	1
18-7162	O-Ring	25-33145	1
18-7173	O-Ring	25-30224	1
18-7176	O-Ring	25-90011	1
18-2801	Water Pump Gasket	27-32438	1
18-7196	O-Ring	25-38099	1
18-7426	O-Ring	35-30271	1

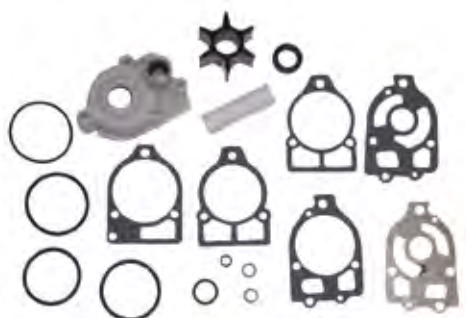

**18-3517**  
**WATER PUMP KIT**  
**Without Base**  
 Replaces: 46-96148A5, 46-60367A1, 46-96148A8

—CONTAINS —

Part #	Desc.	O.E. #	Qty.
18-3109	Water Tube	23-29804	1
18-3017	Impeller	47-89984	1
18-3116	Housing	46-96148A1	1
18-3420	Water Pump Base	46-44292A3	1
18-2919	Water Pump Base to Gear Housing Gasket	27-42631-1	1
18-3110	Grommet	26-38970	1
18-2945	Gear Housing Drain Screw Gasket	12-19183	2
18-2826	Water Pump Base to Gear Housing Gasket	27-85610-1	1
18-2914	Lower Water Pump to Wear Plate Gasket	27-85608-1	1
18-2915	Upper Water Pump to Wear Plate Gasket	27-85609-1	1
18-2944	Seal Ring	26-45577	1
18-3117	Plate	32435	1
18-7158	O-Ring	25-30613	1
18-7162	O-Ring	25-33145	1
18-7173	O-Ring	25-30224	1
18-7176	O-Ring	25-90011	1
18-2801	Water Pump Gasket	27-32438	1
18-7196	O-Ring	25-38099	1
18-7426	O-Ring	35-30271	1



**18-3320**  
**WATER PUMP KIT**  
 For: MR/Alpha I Units  
 S/N 6854393-OD469858

—CONTAINS —

Part #	Desc.	O.E. #	Qty.
18-3109	Water Tube	23-29804	1
18-3017	Impeller	47-89984	1
18-3116	Housing	46-96148A1	1
18-3421	Water Pump Base	46-48748A1	1
18-2919	Water Pump Base to Gear Housing Gasket	27-42631-1	1
18-3110	Grommet	26-38970	1
18-2945	Gear Housing Drain Screw Gasket	12-19183	2
18-2826	Water Pump Base to Gear Housing Gasket	27-85610-1	1
18-2914	Lower Water Pump to Wear Plate Gasket	27-85608-1	1
18-2915	Upper Water Pump to Wear Plate Gasket	27-85609-1	1
18-2944	Seal Ring	26-45577	1
18-3117	Plate	32435	1
18-7158	O-Ring	25-30613	1
18-7162	O-Ring	25-33145	1
18-7173	O-Ring	25-30224	1
18-7176	O-Ring	25-90011	1
18-2801	Water Pump Gasket	27-32438	1
18-7196	O-Ring	25-38099	1
18-7426	O-Ring	35-30271	1



**18-3321**  
**WATER PUMP KIT**  
 For: #1 Units with flush  
 S/N 2495186-2763441

—CONTAINS —

Part #	Desc.	O.E. #	Qty.
18-3109	Water Tube	23-29804	1
18-3017	Impeller	47-89984	1
18-3116	Housing	46-96148A1	1
18-2919	Water Pump Base to Gear Housing Gasket	27-42631-1	1
18-3417	Water Pump Base	46-57234A1	1
18-3110	Grommet	26-38970	1
18-2945	Gear Housing Drain Screw Gasket	12-19183	2
18-2826	Water Pump Base to Gear Housing Gasket	27-85610-1	1
18-2914	Lower Water Pump to Wear Plate Gasket	27-85608-1	1
18-2915	Upper Water Pump to Wear Plate Gasket	27-85609-1	1
18-2944	Seal Ring	26-45577	1
18-3117	Plate	32435	1
18-7158	O-Ring	25-30613	1
18-7162	O-Ring	25-33145	1
18-7173	O-Ring	25-30224	1
18-7176	O-Ring	25-90011	1
18-2801	Water Pump Gasket	27-32438	1
18-7196	O-Ring	25-38099	1
18-7426	O-Ring	35-30271	1
18-2919	Water Pump Gasket	27-46231-1	1



**18-3317**  
**WATER PUMP KIT**  
 For: #1/R Units without flush  
 S/N 2763442-6854392

**COMPLETE WATER PUMP KIT, IMPELLER REPAIR KIT, IMPELLER APPLICATION**

Model	Serial Number	Complete Water Pump Kit	Upper Pump Housing	Upper Pump Kit	Water Pump Base	Impeller Repair Kit	Impeller
#1 Units with plastic flush screw in gear housing	2495186 - 2763441	18-3321	18-3116	18-3517	18-3421	18-3217	18-3017
#1 Units w/o flush screw in gear housing	2763442 - 6854392	18-3317 ①	18-3116	18-3517	18-3417 ①	18-3217	18-3017
MR/ALPHA I	6854393 - OD594568	18-3320	18-3116	18-3517	18-3420	18-3217	18-3017
ALPHA I - Generation II & Vazer	OD494569 & ABOVE	18-3147	--	18-3570	--	18-3214	18-3056
BRAVO/Inboards w/ Plastic pump body	3040411 & ABOVE	--	--	18-3150	--	18-3318	18-3087
BRAVO/Inboards w/ Brass pump body	OM100001 & ABOVE	--	--	18-3160	--	18-3016-1	--

① Models which have been retro-fitted with an Alpha style lower unit (no pre-load pin in top of driveshaft) must use Alpha style parts (18-3320 and 18-3420)

## GENERATION II WATER PUMP ASSEMBLY

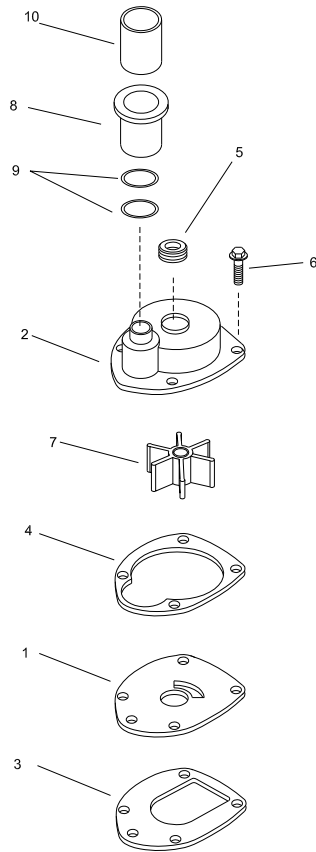

Sequence	Description	Part #	O.E. #	Qty.
1	Face Plate	18-3122	817276	1
2	Housing Assembly	N.S.S.	817275A1	1
3	Gasket, Base	18-2564	27-43033-1	1
4	Gasket, Housing	18-2566	27-817277	1
5	Seal, Face	18-2599	26-816575A2	1
6	Screw, Housing	N/A	10-816928	4
7	Impeller	18-3056	47-43026-2	1
8	Coupling Assembly	18-3151	47-43026T11	1
9	O-Ring	18-7420	25-21836	2
10	Sleeve	18-3222	23-816583	1

## MR ALPHA WATER PUMP ASSEMBLY

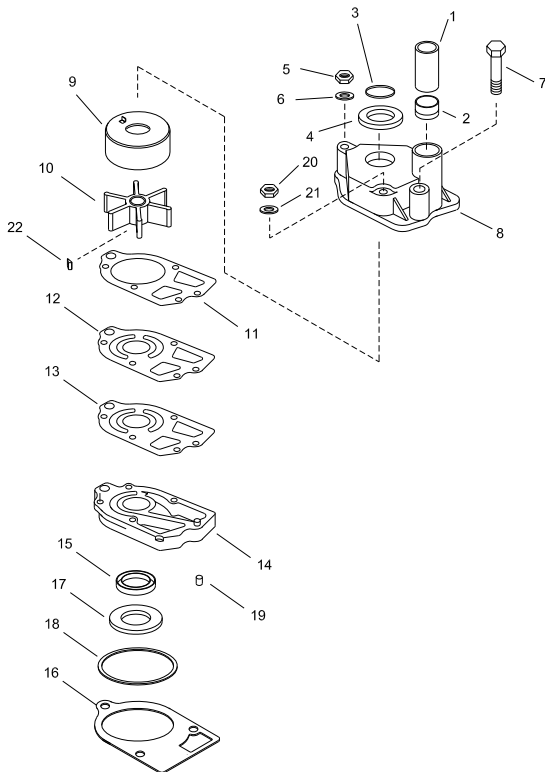

Sequence	Description	Part #	O.E. #	Qty.
1	Guide Sleeve	18-3109	23-29804	1
2	Seal, Sleeve Guide	18-3110	26-38970	1
3	Ring, Upper	18-7158	25-30613	1
4	Ring, Dust	18-7426	25-30271	1
5	Nut, Housing	N/A	11-13436	1
6	Washer, Housing	18-4270	12-36001	3
7	Screw, Housing	N/A	10-96411	1
8	Housing, Water Pump	18-3116	46-96148A1	1
9	Cup, Impeller	18-3114	48752T	1
10	Impeller	18-3017	48752	1
11	Gasket, Impeller	18-2915	47-89984	1
12	Plate, Impeller	18-3117	27-85609-1	1
13	Gasket, Stainless Steel Plate	18-2914	27-85608-1	1
14	Water Pump Base Assembly	18-3420	46-44292A3	1
15	Oil Seal, Water Pump Base	18-2013	26-16977	1
16	Gasket, Water Pump Base	18-2919	27-42631-1	1
17	Oil Seal, Water Pump Base	18-2014	26-89238	1
18	O-Ring, Water Pump Base	18-7176	25-90011	1
19	Pin, Alignment	N/A	17-42836	1
20	Nut, Housing	N/A	11-13438	1
21	Washer, Housing	18-4275	12-29245	2
22	Key, Impeller	N/A	28-56654	1

# R WATER PUMP ASSEMBLY

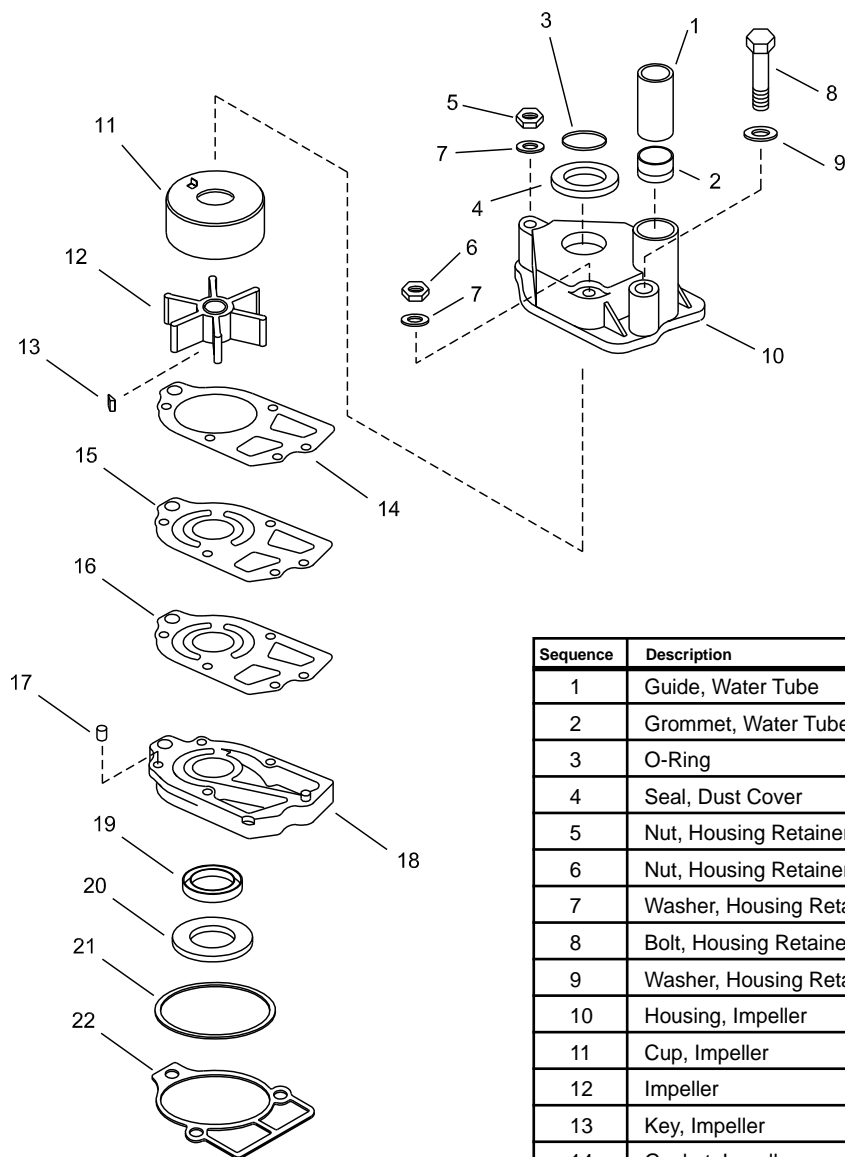

Sequence	Description	Part #	O.E. #	Qty.
1	Guide, Water Tube	18-3109	23-29804	1
2	Grommet, Water Tube Guide	18-3110	26-38970	1
3	O-Ring	18-7158	25-30613	1
4	Seal, Dust Cover	18-7426	25-30271	1
5	Nut, Housing Retainer	18-3723	11-45592	1
6	Nut, Housing Retainer	18-372211-20361, 11-35888		2
7	Washer, Housing Retainer	18-4275	12-29245	3
8	Bolt, Housing Retainer	18-3226	10-30720	1
9	Washer, Housing Retainer	18-4270	12-36001	1
10	Housing, Impeller	18-3116	46-96148A1	1
11	Cup, Impeller	18-3114	48752	1
12	Impeller	18-3017	47-89984	1
13	Key, Impeller	N/A	28-56654	1
14	Gasket, Impeller	18-2915	27-85609-1	1
15	Wear Plate, Impeller	18-3117	32435	1
16	Gasket Wear Plate	18-2914	27-85608-1	1
17	Pin, Alignment	18-3227	17-35973	1
18	Base Assembly	18-3417	46-57234A1	1
19	Oil Seal, Base Assembly	18-2013	26-16977	1
20	Oil Seal, Base Assembly	18-2014	26-89238	1
21	O-Ring, Base Assembly	18-7162	25-33145	1
22	Gasket, Base Assembly	18-2826	27-85610-1	1



**18-3549  
THERMOSTAT**  
Replaces: 14586  
120°



**18-3550  
THERMOSTAT**  
Replaces: 59078  
140°



**18-3551  
THERMOSTAT**  
Replaces: 59137,  
807252T1  
142°



**18-3552  
THERMOSTAT**  
Replaces: 76270, 76270T  
160°



**18-3555  
THERMOSTAT**  
Replaces: 99155A1  
160°



**18-3557  
THERMOSTAT**  
Replaces: 47594  
143°



**18-3649  
THERMOSTAT**  
Replaces: 807252-2  
160°



**18-3568  
THERMOSTAT KIT**  
Replaces: 99155T1

Model	Year	Serial #
5.7MIE	1998-2001	OL002003 & Up
MX6.2LMPI	2000-2001	OL680003 & Up
454 Horizon MIE	1998-2001	OL002200 & Up
502 Mag. MPI	1998-2001	OL017000 & Up



**18-3644  
THERMOSTAT KIT**  
—CONTAINS—

Part #	Description	O.E.#
18-3649	Thermostat 160°	807252T2
18-2553	Thermostat Cover Gasket	27-47510
18-2917	Thermostat Cover Gasket	27-53045-1



**18-3646D** [Display Package](#)

**18-3646  
THERMOSTAT KIT**  
Replaces: 807252Q3  
—CONTAINS—

Part #	Description	O.E.#
18-3551	Thermostat	59137
18-2917	Thermostat Housing Gasket	27-53045-1, 27-33918
18-2844	Thermostat Cover Gasket	27-48818-1
18-2553	Thermostat Cover Gasket	27-47510
18-2834	Thermostat Cover Gasket	27-60208



**18-3647D** [Display Package](#)

**18-3647  
THERMOSTAT KIT**  
Replaces: 807252Q5  
—CONTAINS—

Part #	Description	O.E.#
18-3649	Thermostat	807252-2
18-2844	Thermostat Cover Gasket	27-48818-1
18-2552	Thermostat Cover Gasket	27-33179-2
18-2553	Thermostat Cover Gasket	27-47510
18-7173	O-Ring	25-30224
18-2917	Thermostat Housing Gasket	27-53045-1, 27-33918



**18-3648D** [Display Package](#)

**18-3648  
THERMOSTAT KIT**  
160°



**18-3650D** [Display Package](#)

**18-3650  
THERMOSTAT KIT**  
—CONTAINS—

Part #	Description	O.E.#
18-2831	Thermostat Gasket	27-47590-1
18-3550	Thermostat	59078



**18-3651D** [Display Package](#)

**18-3651  
THERMOSTAT KIT**  
—CONTAINS—

Part #	Description	O.E.#
18-2554	Thermostat Cover Gasket	27-90556
18-2553	Thermostat Cover Gasket	27-47510
18-2834	Thermostat Cover Gasket	27-60208
18-2844	Thermostat Cover Gasket	27-48818-1
18-3551	Thermostat	59137



**18-3652  
THERMOSTAT KIT**  
—CONTAINS—

Part #	Description	O.E.#
18-2555	Thermostat Cover Gasket	27-89656-1
18-2843	Thermostat Cover Gasket	27-74830
18-3552	Thermostat	76270



**18-3667  
THERMOSTAT KIT**  
—CONTAINS—

Part #	Description	O.E.#
18-2555	Thermostat Cover Gasket	27-89656-1
18-3555	Thermostat	99155A1



**18-3668D** [Display Package](#)

**18-3668  
THERMOSTAT KIT**  
Replaces: 807252T4, 807252Q4  
—CONTAINS—

Part #	Description	O.E.#
18-2552	Thermostat Cover Gasket	27-33179-2
18-2553	Thermostat Cover Gasket	27-47510
18-2554	Thermostat Cover Gasket	27-41812
18-3551	Thermostat	59137
18-7173	O-Ring	25-30224
18-2917	Thermostat Housing Gasket	27-53045-1, 27-33918



**18-1977-1  
THERMOSTAT HOUSING**  
Replaces: 47441A1  
Fits 225, GM 260, 228, 898/198,  
185R, 898R, 228R, 2GR

**THERMOSTAT APPLICATION BEGINS ON NEXT PAGE**

① Items ending in "D" are Display Packaged - Regular number is Non-Display



**18-1989  
THERMOSTAT HOUSING**  
Replaces: 87290A4, 861006A1  
**Stainless Steel**  
Use 18-1989K Thermostat Service Kit for replacement parts



**18-1993  
THERMOSTAT HOUSING**  
Replaces: 78984A01, 861493A3



**18-1994  
THERMOSTAT HOUSING**  
Replaces: 87290A4  
For: Stainless Steel Version use 18-1989



**18-3530-1  
THERMOSTAT HOUSING**  
Replaces: 860256A4  
For: GM V6 and V8 (305 & 350 ci)



**18-3531  
THERMOSTAT HOUSING**  
Replaces: 861188A1  
Fits: MCM/MIE GM V-6 & V-8 305,350,454 & 502 cid engines with closed cooling systems



**18-3532  
THERMOSTAT HOUSING AND COVER**  
Replaces: 55131A5  
Fits: MCM/MIE GM V6 & V8, 305, 350, 454, and 502cid, engines with closed cooling



**18-1910  
THERMOSTAT HOUSING KIT**  
Replaces: 861493A07  
Fits: 3.0L GM 1999-Up, S/N 0L340999-Lower



**18-1989K  
THERMOSTAT SERVICE KIT**  
Service Kit for 18-1989 Thermostat Housing

**THERMOSTAT APPLICATION**

Engine / Model	CID / # CYL	Year Range	Beginning Serial #	Ending Serial #	Housing	Thermostat Cover	Thermostat & Gasket Kit	Thermostat	Gaskets Required	Gaskets Required - Design II	Gaskets Required - Design III
ROVER			3140000	UP	—			18-3551	—		
60	68/L4	1965-1968	1887079	2049044				18-3551			
80	80/L4	1966-1969	2049045	2851423				18-3551			
90	96/L4	1970-1972	2851424	3226957				18-3557	18-2831		
100 VASER	98/L4	2007-2010	w995000	& UP					18-1508		
110	153/L4	1963-1966	1537370	2044033		④		18-3551			
110	153/L4	1963-1966	1821720	2044033		⑥		18-3551			
120	153/L4	1964-1972	1666601	3377340		④		18-3551			
120	153/L4	1964-1966	1725593	2046624		⑥		18-3551			
120	153/L4	1967	2046625	2324346		⑥		18-3551			
120	153/L4	1968-1972	2324347	3377340	18-3650	⑥, ③	18-3650	18-3550	18-2831		
120	153/L4	1972-1986	3377341	B531853	18-3650	③	18-3650	18-3550	18-2831		
2.5L	153/L4	1987-1989	B531854	C853255	18-3650	③	18-3650	18-3550	18-2831		
140	181/L4	1968-1986	2508261	B450800	18-3650	③	18-3650	18-3550	18-2831		
140 (6 CYL)			1538930	1725960	—			18-3551			
3.0L	181/L4	1987-1989	B450801	C856558	18-3650	③	18-3650	18-3550	18-2831		
3.0L, FWC	181/L4	1990-2010	C856559	UP		⑥		18-3647	18-3649		
3.0L	181/L4	1990-1994	C856559	F603999	18-3650	⑦, ③		18-3650	18-3550	18-2831	
3.0L	181/L4	2000-2010	L341000	& UP		⑦		18-3647	18-3649	18-2552	
3.0L	181/L4	1998-2000	L010042	L340999	18-3650	⑦, ③		18-3650	18-3550	18-2831	
3.0L MPI	181/L4	2008-2010	A072812	& UP		⑥		18-3647	18-3649	18-2552	
3.0L MPI FWC	181/L4	2008-2010	A072812	& UP		⑥		18-3647	18-3649		
3.0LX, FWC	181/L4	1990-1997	C856559	K999999		⑥		18-3647	18-3649		
3.0LX	181/L4	1990-1997	C856559	K999999	18-1910	⑦, ③	18-3650	18-3550	18-2831		
150			1666495	2048046	—			18-3551			
160			2048022	2770031	—			18-3551			
160			2048022	2233574	—			18-3557			
160			2326069	2770031	—			18-3557	18-2831		
165			2770032	5813433	—		18-3650	18-3550	18-2831		
165	224/L4	1987	B434941	B774251	—		18-3667	18-3555	18-2555		
165			6916779	UP	—		18-3667	18-3555	18-2555		

- ① Design I
- ② Design II
- ③ Design III
- ④ Aluminum Exhaust Manifold
- ⑤ Cast Iron Exhaust Manifold
- ⑥ Closed Cooling
- ⑦ Standard Cooling
- ⑧ With check ball
- ⑨ Without check ball
- ⑩ SN 4167000 & Up
- ⑪ Original thermostat housing listed as NLA. Order update kit 87290A23
- ⑫ Original thermostat housing listed as NLA. Order update kit 90736A24
- ⑬ Complete thermostat housing kit kit
- ⑭ Single and 3-point drain system
- ⑮ 7-point drain system
- ⑯ Mechanical Throttle Body
- ⑰ Digital Throttle Body
- ⑱ Emission Control Engine
- ⑲ Manual drain system
- ⑳ Air Actuated drain system
- ㉑ Old Design
- ㉒ New Design
- ♣ 160 degree
- ♠ For Stainless Steel version use 18-1989

**THERMOSTAT APPLICATION (Cont.)**

Engine / Model	CID / # CYL	Year Range	Beginning Serial #	Ending Serial #	Housing	Thermostat Cover	Thermostat & Gasket Kit	Thermostat	Gaskets Required	Gaskets Required - Design II	Gaskets Required - Design III
170	224/L4	1985-1986	6916779	B434940	18-3667		18-3667	18-3555	18-2555		
175/4.3L 4.3LX (262 CID)	③		B527955	UP	—		18-3668	18-3551	18-2553	18-2554	
175/4.3L 4.3 LX (262 CID)	④		B527955	UP	—		18-3668	18-3551	18-2552	18-7173	
175/4.3L 4.3 LX (262 CID)	④		F001220	UP	—		18-3648	18-3649	18-2552	18-7173	
180/3.7L-LX (4 CYL)			6916779	UP	—		18-3667	18-3555	18-2555		
180	224/L4	1987	B436391	B775248			18-3667	18-3555	18-2555		
185 (229 CID)			6330183	6919655	18-1994	♥	18-3668	18-3551	18-2553	18-2554	
185 (262 CID)			A331455	B527954	18-1994	♥	18-3668	18-3551	18-2553	18-2554	
190			1564539	1730903	—		18-3551	—	—	—	
190	224/L4	1985-1986	6916779	B436390			18-3667	18-3555	18-2555		
3.7L	224/L4	1988-1989	B774552	& UP			18-3667	18-3555	18-2555		
3.7LX	224/L4	1988-1989	B775249	& UP			18-3667	18-3555	18-2555		
470 MCM/MIE	224/L4	1976-1982	4208730	6218036			18-3667	18-3552	18-2555		
470	224/L4	1983-1984	6218037	6916778			18-3667	18-3555	18-2555		
485	224/L4	1980-1982	5685394	6218036			18-3667	18-3552	18-2555		
488	224/L4	1983-1984	6170297	6916778			18-3667	18-3555	18-2555		
140 (6 CYL)	194/L6	1963	1538930	1725960				18-3551	—	—	
150	230/L6	1964-1966	1666495	2048046	④			18-3551	—	—	
150	230/L6	1964-1966	1727985	2048046	⑤			18-3551	—	—	
160	250/L6	1967-1969	2048022	2770031	④			18-3551	—	—	
160	250/L6	1967	2048022	2233574	⑤			18-3551	—	—	
160	250/L6	1968-1969	2326096	2770031	18-1910	③, ⑤		18-3557	18-2831		
165 (6 CYL)	250/L6	1970-1981	2770032	5813433	18-1910	③	18-3650	18-3550	18-2831		
200 (6 CYL)	292/L6	1969	2453769	2712072	18-1910	③		18-3557	18-2831		
185 (4bb)	229-V-6	1983-1984	6330183	6919655	18-3678		18-3668	18-3551	18-2554	18-2553	18-2917
175	262/V-6	1987	B527955	B773242	18-1994	①	18-1977-1	18-3668	18-3551	18-2554	18-2917
175	262/V-6	1987	B527955	B773242	②, ③		18-3668	18-3551	18-7173	18-2917	
185 (2bb)	262/V-6	1985-1986	A331455	B527954	18-1994		18-1977-1	18-3668	18-3551	18-2554	18-2917
205	262/V-6	1985-1986	A331455	B527954	18-3668		18-1977-1	18-3668	18-3551	18-2554	18-2917
205	262/V-6	1987	B527955	B775129	18-3668	①	18-1977-1	18-3668	18-3551	18-2554	18-2917
205	262/V-6	1967	B527955	B775129	②, ③		18-3668	18-3551	18-7173	18-2552	18-2917
205/4.3L 4.3 LX (262 CID)	④		B527955	D714369	—	②	18-3668	18-3551	18-2552	18-7173	
205/4.3L 4.3 LX (262 CID)	④		F001220	UP	—		18-3648	18-3649	18-2552	18-7173	
215 FORD			2781153	3040410	—			18-3551	—	—	
215 FORD			3040411	UP	—		18-3651	18-3551	18-2834	—	
215 FORD MCM/MIE			3040411	3385720	—		18-3646	18-3649	18-2834	—	
225 FORD MCM/MIE			3385721	4176999	—		18-3646	18-3649	18-2834	—	
262 MAG EFI ALPHA	262/V-6	1996-1997	0F803800	0K999999	18-3647		18-3647	18-3649	18-2917		
262 MAG EFI BRAVO	262/V-6	1996-1997	0F803800	0K999999	18-3647		18-3647	18-3649	18-2917		
4.3L	262/V-6	1988-1993	B773243	F000877	18-1994	①	18-1977-1	18-3668	18-3551	18-2554	18-2917
4.3L	262/V-6	1987-1993	B773243	F000877		②, ③		18-3668	18-3551	18-7173	18-2917
4.3L	262/V-6	1993-1995	F000878	F601126	18-3647	②, ④		18-3668	18-3649	18-2917	18-2552
4.3L	262/V-6	1993-1995	F000878	F601126		⑤		18-3668	18-3551	18-0398	
4.3L FWC	262/V-6	1993-2002	F000878	M614999	18-3531	⑥		18-3568	18-3555	18-0398	
4.3L ALPHA	262/V-6	1996-2002	0F601127	M614999	18-3647	⑦		18-3647	18-3649	18-2917	
4.3L BRAVO	262/V-6	1996-2002	0F601127	M614999	18-3647	⑦		18-3647	18-3649	18-2917	
4.3L FWC	262/V-6	2002-2010	M615000	& UP		⑧		18-3647	18-3649	18-0398	
4.3L	262/V-6	2002-2010	M615000	& UP		⑦	18-3647	18-3649	18-0398		
4.3L EFI FWC	262/V-6	1998-2001	L012009	M299999	18-3531	⑧		18-3568	18-3555	18-0398	
4.3L EFI ALPHA	262/V-6	1998-2001	L012009	M299999		⑦		18-3647	18-3649	18-0398	
4.3L EFI BRAVO	262/V-6	1998-2001	L012009	M299999	18-3530-1	⑦		18-3647	18-3649	18-0398	
4.3L MPI	262/V-6	2002-2010	M300000	& UP		⑦, ④		18-3647	18-3649	18-0398	
4.3L MPI	262/V-6	2002-2010	M300000	& UP		⑦, ⑤		18-3647	18-3649	18-0398	
4.3L MPI EC	262/V-6	2010-2011	A637496	& UP		⑦, ⑧		18-3647	18-3649	18-0398	
4.3L MPI FWC	262/V-6	2002	M300000	M614999		⑧	18-3568	18-3555	18-0398		
4.3L MPI FWC	262/V-6	2002-2010	M615000	& UP		⑧		18-3647	18-3649	18-0398	
4.3LH FWC	262/V-6	1998-2002	L010044	M614999	18-3531	⑧		18-3568	18-3555	18-0398	
4.3LH ALPHA	262/V-6	1998-2002	L010044	M614999		⑦		18-3647	18-3649	18-0398	
4.3LH BRAVO	262/V-6	1998-2002	L010044	M614999	18-3530-1	⑦		18-3647	18-3649	18-0398	
4.3LX	262/V-6	1988-1993	B775130	F001219	18-1994	①	18-1977-1	18-3668	18-3551	18-2554	18-2917
4.3LX	262/V-6	1988-1993	B775130	F001219		②, ③		18-3668	18-3551	18-7173	18-2552
4.3LX	262/V-6	1993-1995	F001220	F601126		②, ④		18-3668	18-3551	18-7173	18-2552
43LX	262/V-6	1993-1995	F001220	F601126		②		18-3668	18-3551	18-0398	18-2917
4.3LX FWC	262/V-6	1993-1997	F001220	K999999		⑧		18-3567	18-3555	18-0398	
4.3LX ALPHA	262/V-6	1996-1997	F601127	K999999		⑦		18-3647	18-3649	18-0398	
4.3LX BRAVO	262/V-6	1996-1997	F601127	K999999	18-3530-1	⑦		18-3647	18-3649	18-0398	
4.3LXH FWC	262/V-6	1996-1997	F803114	K999999	18-3531	⑧		18-3568	18-3555	18-0398	
4.3LXH ALPHA	262/V-6	1996-1997	F803114	K999999	18-3530-1	⑦		18-3647	18-3649	18-0398	
4.3LXH BRAVO	262/V-6	1996-1997	F803114	K999999	18-3530-1	⑦		18-3647	18-3649	18-0398	
215 MCM/MIE (FORD)	302/V-8	1970	2781153	3040410				18-3551	18-2834		
215 MCM/MIE (FORD)	302/V-8	1971-1972	3040411	3385720			18-3646	18-3551	18-2834		
225 MCM/MIE (FORD)	302/V-8	1973-1974	3385721	4176999			18-3646	18-3551	18-2834		
888 (FORD)	302/V-8	1971-1977	3108723	4887829		⑩	18-3646	18-3551	18-2834		
190	283/V-8	1963-1964	1564539	1730903				18-3551	—	—	
198 MIE	305/V-8	1977	4776402	4931099			18-1977-1	18-3646	18-3551	18-2844	18-0398
200	305/V-8	1985-1987	6899058	B774444	18-1994		18-1977-1	18-3668	18-3551	18-2554	18-2553
200 GM			6218462	B525981	18-1994	♥	18-3668	18-3551	18-2553	18-2554	
200/5.0L			0B525982	0F600999			18-3647	18-3649	18-2917	—	
200/5.0L GM	③		B525982	UP	18-1994	♥	18-3668	18-3551	18-2553	18-2554	
200/5.0L GM	④		B525982	UP	18-1994	♥	18-3648	18-3649	18-2552	18-7173	
228	305/V-8	1977-1982	4765100	6218461			18-1977-1	18-3646	18-3551	18-2844	18-0398
228	305/V-8	1982-1984	6218462	6899268	18-1994		18-1977-1	18-3668	18-3551	18-2554	18-2553
228 MIE	305/V-8	1977-1980	4765100	5907057	18-3651		18-1977-1	18-3646	18-3551	18-2844	18-1993
230	305/V-8	1985-1987	6899269	B773739	18-1994		18-1977-1	18-3668	18-3551	18-2554	18-2553
230 MIE	305/V-8	1981-1987	5907058	B788151	18-1994		18-1977-1	18-3668	18-3551	18-2554	18-2553
230 MIE FWC	305/V-8	1981-1987	5907058	B788151		⑥	18-1977-1	18-3646	18-3551	18-2553	18-2844
230 GM			6218462	B525981	18-1994	♥	18-3668	18-3551	18-2553	18-2554	
230 MIE			5907058	0B5225505			18-3646	18-3649	18-2553	18-2844	18-2917
230 GM IB	⑤		5907058	B522505		⑦	18-3668	18-3551	18-2553	18-2554	
230 GM IB	⑥		5907058	B522505		⑦	18-3651	18-3551	18-2553	18-2844	











**18-7702**  
**AIR CHARGE**  
**TEMPERATURE SENDER**  
 Replaces: 805223T  
 Fits: Mercruiser V6 & V8(350, 454, 496  
 & 502 cid)MPI engines



**18-5897**  
**SENDER**  
 Replaces: 97257A1, 806490T  
 For Water Temperature  
 3/8" - 18 NPT



**18-5898**  
**SENDER**  
 Replaces: 97258A1  
 For Water Temperature  
 1/2" -14 NPT



**18-5899**  
**OIL PRESSURE SENDER**  
 Replaces: 90806, 815425T  
 For Oil Pressure

**TEMPERATURE SENDER/OIL SENDER APPLICATION**

Model	Serial #	Oil Pressure	Water Temperature	Model	Serial #	Oil Pressure	Water Temperature
ROVER	3140000F & UP	—	18-5897	270	2851074-3077735	18-5899	18-5897
110	1565944-1566081	18-5899	18-5898	280	4176250 & UP	18-5899	18-5898
110	1602980 & UP	18-5899	18-5898	300 MR/TRS	6668677 & UP	18-5899 ②	18-5897 ②
120	2324346 & BELOW	18-5899	18-5898	320	A543604 & UP	18-5899 ②	18-5897 ②
120	2324347 & UP	18-5899 ① ②	18-5897 ②	325	2278747 & UP	18-5899	18-5897 ⑧ ⑨
140 (4 cyl/3.0)	2508061 - 3462607	18-5899 ②	18-5897 ②	330	4623115 & UP	18-5899	18-5898
140 (4cyl/3.0)	4512156 & UP	18-5899 ②	18-5897 ②	330/W.B.W.	6083145 & UP	18-5899 ②	18-5897 ②
3.0L/3.0LX	C856559 & UP	18-5899 ②	18-5897 ②	340/7.4L	5889914 & UP	18-5899 ②	18-5897 ②
140 (6 cyl)	1566119-1725960	18-5899	18-5898	350	3780450 & UP	18-5899	18-5898
150	1666495-2048046	18-5899	18-5898	350 (Magnum)	A635178- B525981	18-5899 ②	18-5897 ②
160	2048022-2770031	18-5899	18-5897 ④ ⑤	350 (Magnum)	B525982-0505449	—	18-5897 ② ⑥ ⑦
165	2770032 & UP	18-5899	18-5897	350 (Magnum)	D505450 & UP	18-5899 ②	18-5897 ②
165/3.7L/170/180	6916779 & UP	18-5899	—	370 (TRS)	4179554 & UP	18-5899 ②	18-5897 ②
175 (262 CID)	B527955 & UP	18-5899 ②	18-5897 ② ⑥ ⑦	390	2781129-2825059	18-5899	18-5897
4.3L (Generation II)	D714107 & UP	18-5899 ②	18-5897 ②	400	4179554 & UP	18-5899	18-5897
185 (229 CID)	6330183 & UP	18-5899 ②	18-5897 ②	420/425	A398941 & UP	18-5899 ②	18-5897 ②
185 (262 CID)	A331455 & UP	18-5899 ②	18-5897 ②	440	4179554 & UP	18-5899	18-5897
190	1504311-1730903	18-5899	18-5898	454 (Magnum)	A631894 & UP	18-5899 ②	18-5897 ②
190 (4 cyl)	6916779 & UP	18-5899	—	454 (Bravo)	B721206-D805068	18-5899 ②	18-5897 ② ⑥ ⑦
200	2453769-271202	18-5899	18-5897	460	4179554	18-5899	18-5897
200	6218462 & UP	18-5899 ②	18-5897 ②	465	C849992 & UP	18-5899 ②	18-5897 ②
200/5.0	B525982 & UP	—	18-5897 ② ⑥ ⑦	500	C577254 & UP	18-5899 ②	18-5897 ②
205 (262 CID)	A331455 & UP	18-5899 ②	18-5897 ②	502 (Bravo)	C878221 & UP	18-5899 ②	18-5897 ②
205 (4.3L)	B527955 & UP	18-5899 ②	18-5897 ② ⑥ ⑦	502 (Bravo Gen V)	D824589 & UP	—	18-5897
4.3LX (Generation II)	D714370 & UP	18-5899 ②	18-5897 ②	525	D456000 & UP	18-5899 ②	18-5897 ②
215	2781153 & UP	18-5899	18-5897	575	A677429 & UP	18-5899 ②	18-5899 ②
225 (Ford)	3385721 & UP	18-5899	18-5897	888	3108723 & UP	18-5899	18-5897
225 (GM)	1632308-2694014	18-5899	18-5897 ⑧ ⑨	898	4762210-6218461	18-5899	18-5898
228	4765100-6218461	18-5899	18-5898	898	6218462 & UP	18-5899 ②	18-5897 ②
228 & 230	6218462 & UP	18-5899 ②	18-5897 ②	5.7	A338553-B514626	18-5899 ②	18-5897 ②
230 (I.B.)	5907058 & UP	18-5899 ②	18-5897 ②	5.7	B514627-B525981	18-5899 ②	18-5897 ② ⑥ ⑦
230 (5.0)	B522506 & UP	18-5899 ⑩	18-5897 ⑥ ⑦	5.7 (Bravo)	B525982 & UP	—	18-5897 ⑥ ⑦
233 Ford	4173000 & UP	18-5899	18-5898	7.4 (Bravo)	B771113-D803117	18-5899 ②	18-5897 ② ⑥ ⑦
250	9314301-4908849	18-5899	18-5897 ⑧ ⑨	7.4 (Bravo Gen V)	D803118 & UP	—	18-5897 ②
255	3258728 & UP	18-5899	18-5898	7.4L (Hurth)	ALL	18-5899 ②	18-5897 ②
260	4908850-6218461	18-5899	18-5898	454	D805069 & UP	—	18-5897 ②
260	6218462 & UP	18-5899 ②	18-5897 ②	8.2	C878221-D857199	18-5899 ②	18-5897 ②
260/5.7	B522506 & UP	18-5899 ⑩	18-5897 ⑥ ⑦	8.2	D857200 & UP	—	18-5897 ②
260	5907058 & UP	18-5899 ②	18-5897 ②				

① S/N - 3377341-3461707 & 5192049 & UP

② Does not include Dual application

④ 2326096 & UP

⑤ 2233574 & Below use 18-5898

⑥ (3/8 - 18)

⑦ (1/2 -14) Use 18-5898

⑧ Electric Choke

⑨ Auto Choke

⑩ Thru S/N B525981 only

**18-70944  
MOLDED HOSE**

Replaces: 32-861590A05

Fits: 4.3L Alpha/Bravo Carb(2002 & Up), 350 Black Scorpion Ski (Gen+) (1997-01), 6.2L Black Scorpion Ski (Gen+) (2001-02), Black Scorpion 350 Mag MPI(2002), Black Scorpion MX 6.2L MPI (2002)



**18-70948  
MOLDED HOSE**

Replaces: 32-808033

Fits: 262 Mag EFI Bravo w/Fuel Cool System (1996-97), 4.3L EFI (TBI) (1998-01), 5.0L (Gen+) Bravo (1998-07), 5.0L EFI (Gen+) (1998-01), 350 Mag Alpha (Gen+) (1997), 350 Mag Alpha EFI (Gen+) (1997), 350 Mag Bravo MPI (Gen+) (1997), 350 Mag MPI (Gen+) (1998-01), 5.7L (1997), 5.7L (Gen+) (1998-07), 5.7L EFI (1997), 5.7L EFI (Gen+) 1998-2001, 5.7LX (1997), 5.7LX Bravo EFI (Gen+) (1997), 5.7LX EFI (1997)  
For: Cooler to thermostat housing



**18-70949  
MOLDED HOSE**

Replaces: 32-807407

Fits: 454 Mag MPI (Gen VI) (1996-01), 7.4LX MPI Bravo (Gen VI) (1996-97), 502 Mag MPI (Gen VI) (1996-01) For: Cooler to thermostat housing



**18-70954  
MOLDED HOSE**

Replaces: 32-8600891

Fits: 5.0L (Gen+) Bravo (1998-07), 5.0L EFI (Gen+) Alpha & Bravo (1998-01), 350 Mag Alpha (1997), 350 Mag EFI (Gen+) Alpha (1997), 350 Mag EFI (Gen+) Alpha (1997), 350 Mag MPI (Gen+) Bravo (1997-01), 350 Mag MPI (Gen+) Alpha (1998-01), 5.7L Alpha & Bravo (1997), 5.7L (Gen+) Alpha & Bravo (1998-07), 5.7L EFI Bravo (1997-01), 5.7LX Alpha & Bravo (1997), 5.7LX EFI (Gen+) Alpha & Bravo (1997), 6.2L MPI (2000-01) For: oil cooler to oil cooler



**18-70956  
MOLDED HOSE**

Replaces: 32-16012

Fits: MC175/205 (1987), 4.3L (1988-92), 4.3L (Gen II) (1992-95), 4.3LX (Gen II) (1992-95) For: Oil cooler to thermostat housing with all four hose connectors cast into the thermostat housing (No "T" connector) Two hoses to manifold and two hoses to elbow.



**18-70955  
MOLDED HOSE**

Replaces: 32-16011

Fits: MC200/230 (1987), 5.0L Alpha (1988-95), 5.0LX Alpha (1988-95), MC260 (1987), 350 Mag Alpha (1987-95), 5.7L Alpha & Bravo (1988-95), 454 Mag Bravo (1988-92), 7.4L (GenV) Bravo (1992-96)  
For: Oil cooler to thermostat housing with all four hose connectors cast into the thermostat housing (No "T" connector) Two hoses to manifold and two hoses to elbow.



**18-70952  
MOLDED HOSE**

Replaces: 32-887952

Fits: 5.0 L Bravo (1988-95), 5.0LX Bravo (1988-95), 350 Mag MPI Bravo (1995), 350 Mag MPI (Gen+) Bravo (1996), 5.7L Bravo (1988-96), 5.7L EFI 1995, 5.7L EFI Bravo (1996), 5.7LX EFI (Gen+) Bravo (1996) For: Seawater pump to oil cooler



**18-70953  
MOLDED HOSE**

Replaces: 32-8080441

Fits: 5.0L EFI (Gen+) Bravo (1998-01), 350 Mag MPI (Gen+) (1998-01), 5.7L Bravo (1997), 5.7L (Gen+) Bravo (1998-07), 5.7L EFI Bravo 1997, 5.7L EFI (Gen+) Bravo (1998-01), 5.7LX Bravo (1997), 5.7LX EFI (Gen+) Bravo (1997), 6.2L MPI (2000-01) For: Seawater pump to oil cooler



**18-70951  
MOLDED HOSE**

Replaces: 32-860205

Fits: 262 Mag. EFI Bravo (1996-97), 4.3L (Gen+) Bravo (1998-07), 4.3L TBI (Gen+) Bravo (1998-01), 4.3LH (Gen+) Bravo (1998-02), 4.3LX(H) (Gen+) Bravo (1996-97) For: Seawater pump to oil cooler



**18-70945  
MOLDED HOSE**

Replaces: 32-862139

Fits: 4.3L (Gen+) (1998-07), 4.3L EFI (Gen+) (1998-01), 4.3LH (Gen+) (1998-02)  
For: Thermostat housing to port manifold with 2 piece exhaust manifold





**18-70947**  
**MOLDED HOSE**

Replaces: 32-862124  
Fits: 4.3L (Gen+) (1998-07) (S/N 0L619000 & UP), 4.3L EFI (Gen+) (2000-01), 4.3LH (Gen+) (2000-02) For: Thermostat housing to starboard manifold with 2 piece exhaust manifold



**18-70946**  
**MOLDED HOSE**

Replaces: 32-8066362  
Fits: 262 Mag EFI (Gen+) (1996-97), 4.3L (Gen+) (1998-07) (S/N 0L01004-0L618999), 4.3L EFI (Gen+) (1998-00), 4.3LH (Gen+) 1998-00), 4.3LX (Gen+) (1996-97), 4.3LXH (Gen+) (1996-97)  
For: Thermostat housing to starboard manifold with 2 piece exhaust manifold



**18-70950**  
**MOLDED HOSE**

Replaces: 32-807661  
Fits: 3.0L (1999-07), 262 Mag EFI Alpha (1996-97), 4.3L (Gen+) Alpha (1998-07), 4.3L EFI (TBI Gen+) Alpha (1998-01), 4.3LH (Gen+) Alpha (1998-02), 4.3LX(H) (Gen+) Alpha (1996-97), 5.0L (Gen+) Alpha (1998-07), 5.0L EFI (Gen+) Alpha (1998-01), 350 Mag. Alpha (1997), 350 Mag. EFI (Gen+) Alpha (1997), 350 Mag. MPI (Gen+) Alpha (1998-01), 5.7L Alpha (1997), 5.7L (Gen+) Alpha (1998-07), 5.7L EFI Alpha (1997), 5.7L EFI (Gen+) Alpha (1998-01), 5.7LX Alpha (1997) For: Transom to oil cooler



**18-70957**  
**MOLDED HOSE**

Replaces: 32-41642A3  
Fits: MC185 (1983-86), MC175 (1987), MC205 (1985-87), 4.3L (1988-92), 4.3L (Gen II) & 4.3LX (Gen II) (1992-95) For: Transom to oil cooler



**18-70958**  
**MOLDED HOSE**

Replaces: 32-96246A4  
Fits: MC898 (1983-84), MC200 (1985-87), MC228 (1982-84), MC230 (1985-87), 5.0L & 5.0LX Alpha (1988-95), MC260 (1983-87), 300 Tempest MR (1985-86), MC320 EFI (1987-89), 350 MAG Alpha (1986-96), 5.7L Alpha (1988-96), 5.7LX & 5.7LX EFI Alpha (1996), 454 MAG Alpha (1986-88)  
For: Transom to oil cooler



**18-70933**  
**MOLDED HOSE**

Replaces: 32-861634  
Fits: 3.0L I/L 4 (1999 & Up)



**18-70934**  
**MOLDED HOSE**

Replaces: 32-897181  
Fits: 330 (1977-87), 330 MIE (1977-80), 340 MIE W/ BW (1981-87), 370 TRS (1978-87), 400 TRS (1980-86), 420 (1987-89), 425 (1990-92), 425 (Gen V) (1992-93), 440 TRS (1983-86), 450 (Gen V) (1995-96), 454 EFI (Gen V) (1994-96), 454 Mag Alpha (1986-88), 454 Mag Bravo (1988-92), 454 Mag Bravo(Gen V) (1992-97), 454 Mag MPI Bravo(Gen VI) (1996-98), 454 Mag MPI SKI (Gen VI)(1996-97), 460 TRS (1983-86), 465 (1990-92), 465 (Gen V) (1992-94), 500 Gen+ (1999), 500 (Gen V) (1994-96), 500 (Gen VI)(1997-98), 502 EFI (Gen V)(1993-95), 502 Mag Bravo (1990-92), 502 Mag MPI Bravo (Gen VI), 502 Mag Bravo(Gen V)(1992-93), 502 Mag MPI(Gen VI)(1996), 7.4L MIE W/BW (1988-92), 7.4L Bravo (1988-91), 7.4L Bravo(Gen V)(1992-96), 7.4L Bravo (Gen VI)(1996-97), 7.4L MIE (LH)(Gen V)(1992-96), 7.4L MIE (LH)(Gen VI)(1996-97), 7.4L MIE W/Hurth (1989-92), 7.4L MIE MPI (LH)(Gen VI)(1996-97), 7.4L TBI MIE (LH)(Gen VI)(1996-97), 7.4LX Bravo MPI(Gen V)(1996-97), 7.4LX Bravo TBI(Gen VI)(1996-97), 8.2L MIE (Gen V)(1993-96), 8.2L MIE MPI (Gen VI), 8.2



**18-70935**  
**MOLDED HOSE**

Replaces: 32-806856  
Fits: 200 2bbl (1987), 230 4bbl (1987), 260 (1987), 350 Mag SKI (1991-96), 350 Mag Alpha (1987-95), 350 Mag Alpha 4bbl (1996), 350 Mag Alpha EFI (Gen+)(1996), 350 Mag Bravo MPI (1995), 350 Mag Bravo MPI (Gen+)(1996), 350 Mag EFI SKI TBI (1994-96), 350 Mag MPI SKI (1995-96), 4.3L (Gen II)(2bbl)(1993-96), 4.3LX (Gen II)(4bbl)(1993-96), 5.0L 2bbl (1988-95), 5.0LX 4bbl (1988-95), 5.7L (1988-95), 5.7L 2bbl (1996), 5.7L Alpha EFI TBI (1995), 5.7L Bravo EFI TBI(1995), 5.7L Competition SKI (1996), 5.7L EFI (2bbl TBI) (1996), 5.7L MIE (1996), 5.7LX 4bbl (1996), 5.7LX Bravo EFI (Gen+)(1996), 5.7LX EFI 4bbl TBI (1996), Black Scorpion(Gen+)(1996) For: Oil cooler to thermostat housing.



**18-70938**  
**MOLDED HOSE**

Replaces: 32-8066351  
Fits: 262 Mag with VST (1996-97), 4.3L-LX (1993-96) Design III, 5.0L-LX (1988-95) Design III, 350Mag-EFI-MPI (1987-96), 5.7L-LX 88-96 Design III.  
For: Thermostat housing to port exhaust manifold



**18-70939**  
**MOLDED HOSE**

Replaces: 32-8066361  
Fits: 4.3L-LX (1993-96) Standard Cooling Design III, 5.0L-LX/5.7L-LX (1988-95) Standard Cooling Design III, 350 Mag (1987-95) Standard Cooling Design III.  
For: Thermostat housing to starboard exhaust manifold



**18-70940**  
**MOLDED HOSE**

Replaces: 32-860144  
Fits: 262 Mag with Fuel Cool, 4.3L-LX (1996 & Up) with 1 pc. manifold, 5.0L-EFI (1998 & Up), 350 Mag-MPI 97-01, 5.7L-EFI (1996-97), 6.2L MPI(20 01& Up).  
For: Thermostat housing to port exhaust manifold



**18-70941**  
**MOLDED HOSE**

Replaces: 32-807697  
Fits: 262 Mag with 1 piece exhaust, 4.3L (1998 & Up) with 1 piece exhaust, 4.3LX-EFI (1996-01) with 1 piece exhaust, 5.0L (Gen+) (1998& Up), 5.0L EFI (1998-01), 350Mag EFI-MPI 97-01, 5.7L-LX (1997-98).  
For: Thermostat housing to starboard exhaust manifold



**18-70942**  
**MOLDED HOSE**

Replaces: 32-897301  
Fits: 7.4L, 454 Mag, 502 Mag. For: Thermostat housing to starboard exhaust manifold



**18-70943**  
**MOLDED HOSE**

Replaces: 32-897491  
Fits: 7.4L, 454 Mag, 502 Mag. For: Thermostat housing to port exhaust manifold



**18-3601**  
**GIMBAL HOUSING WATER FEED HOSE**

Replaces: 32-32461  
Dia.  $\frac{5}{8}$ "  
Length  $13 \frac{7}{8}$ "



**18-3602**  
**WATER INTAKE HOSE**

Replaces: 32-4172533  
 $13 \frac{7}{8}$ " Length -  $\frac{3}{4}$ " I.D.  
For: MR, Alpha I, Gen II



**18-3603**  
**WATER INTAKE HOSE**

Replaces: 32-43437



**18-70925**  
**MOLDED HOSE**

Replaces: 32-160211  
For: 4.3L, 5.0L, & 5.7L  
For: Thermostat Cover to Port Manifold



**18-70926**  
**MOLDED HOSE**

Replaces: 32-73796  
For: 5.0L & 5.7L  
For: Thermostat Cover to Exhaust Elbow



**18-70927**  
**MOLDED HOSE**

Replaces: 32-73795  
For: 5.0L & 5.7L Port  
For: Thermostat Housing to Port Manifold



**18-70928**  
**MOLDED HOSE**  
 Replaces: 32-71613  
 For: 5.0L & 5.7L  
 For: Thermostat Housing to Oil Cooler



**18-70929**  
**MOLDED HOSE**  
 Replaces: 32-73794  
 For: 5.0L & 5.7L Starboard  
 For: Thermostat Housing to Starboard Manifold



**18-70930**  
**MOLDED HOSE**  
 Replaces: 32-52481  
 For: GM Inline 4 & 6 cyl.  
 For: Water Distribution Block to End Cap



**18-70931**  
**MOLDED HOSE**  
 Replaces: 32-96879  
 For: 2.5L & 3.0L  
 For: Distribution Block to Water Pump

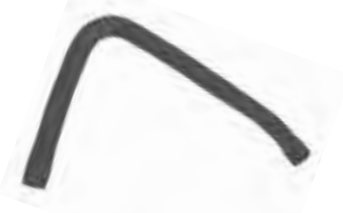

**18-70932**  
**MOLDED HOSE**  
 Replaces: 32-871171  
 For: 4.3L, 5.0L, & 5.7L Starboard  
 For: Thermostat Cover to Starboard Manifold

**SINGLE DIAMETER HOSE**



**4 3/4"**

**18-70021**  
**MOLDED HOSE**  
 3/4" ID



**5"**

**18-70704**  
**MOLDED HOSE**  
 1 1/4" ID  
 For: 3.7L



**5"**

**18-70924**  
**MOLDED HOSE**  
 1 3/4" ID



**12 1/2"**

**18-71218**  
**MOLDED HOSE**  
 1" ID  
 For: 230 & 260 MIE



**12 3/4"**

**18-71337**  
**MOLDED HOSE**  
 1 3/4" ID  
 For: 4.3L, 5.0L, 5.7L  
 Circulating Pump Hose

**STRAIGHT HOSE**



**18-75100**  
**MOLDED HOSE**  
 Straight 48"  
 1" ID



**18-75125**  
**MOLDED HOSE**  
 Straight 48"  
 1 1/4" ID



## HOSE INTERCHANGE

Part #	Mercruiser Part #	Part #	Mercruiser Part #	Part #	Mercruiser Part #	Part #	Mercruiser Part #
18-70925	32-16021 1	18-70928	32-71613	18-70935	32-806856	18-70704	32-89653
18-3601	32-32461	18-70929	32-73794	18-70941	32-807697	18-70934	32-89718 1
18-71337	32-33189	18-70927	32-73795	18-70940	32-860144	18-70942	32-89730 1
18-3602	32-41725-33	18-70926	32-73796	18-70933	32-861634	18-70943	32-89749 1
18-3603	32-43437	18-70938	32-806635 1	18-71337	32-87108	18-70931	32-96879
18-71218	32-48132	18-70939	32-806636 1	18-70932	32-87117 1		
18-70930	32-52481						

## V-BELTS



- 1 High strength synthetic cords resist shockload failure. Their low stretch properties assure uniform performance over the life of the belt.
- 2 The compression section is a special rubber compound that assures smooth and even transfer of load forces to the cords.
- 3 Cogs are molded to precise engineering tolerances to improve flexibility and maintain cord support. Cog geometry provides a large area for air circulation to keep the belt cool and prevent damaging heat build up in the cushion section.
- 4 Rubber edges maintain positive, no-slip contact with pulley grooves for reliable energy transfer.

### BELT SIZE LISTING BY NUMBER

Part #	OE #	Effective Length (Inches)	Top Width (Inches)	Part #	OE #	Effective Length (Inches)	Top Width (Inches)
18-15290	57-13457,T	29	29/64	18-15435	57-64416	43 1/2	29/64
18-15300	57-49756	30	29/64	18-15440	57-49213A1,57-45856	44	29/64
18-15325	57-77274A1	32 1/2	29/64	18-15450	-	45	29/64
18-15345	57-74271T	34 1/2	29/64	18-15455	-	45 1/2	29/64
18-15370	57-65607T	37	29/64	18-15460	57-48120A1	46	29/64
18-15380	-	38	29/64	18-15470	57-78200A1	47	29/64
18-15390	57-52692	39	29/64	18-15480	57-48122	48	29/64
18-15400	57-32850,57-69143T	40	29/64	18-15490	57-816295T	52 1/2	29/64
18-15405	57-76269	40 1/2	29/64	18-15495	57-91035A1	49 1/2	29/64
18-15410	57-49043A1,			18-15500	57-96834T,Q	50	29/64
	57-64032A1,57-98043	41	29/64	18-15520	57-33170,Q,57-37619T	52	29/64
18-15415	57-36356	41 1/2	29/64	18-15550	57-13458T	55	29/64
18-15430	57-49211	43	29/64				

**V-BELT APPLICATION**

HP	Liter	Model	Years	CID	# Cyl	Stroke	Serial #	Type of Belt	Alternator/ Water Pump	Power Steering	Sea Water Pump
110		110	1963-1966	153	4	4	1537370 - 2044033	V-BELT	18-15410	— —	—
120		120	1964-1973	153	4	4	1686601 - 3770649	V-BELT	18-15410	— —	—
120		120	1974-1982	153	4	4	3770650 - 6229717	V-BELT	18-15410	— —	—
120		120	1974-1982	153	4	4	3770650 - 6229717	V-BELT	18-15410	18-15400	40" BELT
120		120	1982-1986	153	4	4	6229718 - b531853	V-BELT	18-15410 <b>19</b>	— —	—
120		120	1982-1986	153	4	4	6229718 - b531853	V-BELT	18-15400 <b>18</b>	— —	—
120	2.5L	120	1982-89	153	4	4	6229718 - C853255	V-BELT	18-15410	— —	—
120	2.5L	120	1982-89	153	4	4	6229718 - C853255	V-BELT	18-15400	18-15370	—
140		140	1968-73	181	4	4	2508261-3770649	V-BELT	18-15410	— —	—
140		140	1974-82	181	4	4	3770650-6229717	V-BELT	18-15410	18-15370	37" BELT
140		140	1974-82	181	4	4	3770650-6229717	V-BELT	18-15410	18-15400	40" BELT
140	3.0L	140 / 3.0L / 3.0LX	1982-1986	181	4	4	6229718 - B450800	V-BELT	18-15410 <b>19</b>	— —	—
140	3.0L	140 / 3.0L / 3.0LX	1982-1999	181	4	4	6229718 - B450800	V-BELT	18-15400 <b>18</b>	18-15370	—
140	3.0L	3.0L	1987-1994	181	4	4	6229718 - F603999	V-BELT	18-15400 <b>18</b>	18-15370	—
140	3.0L	3.0L	1987-1994	181	4	4	6229718 - F603999	V-BELT	18-15400 <b>18</b>	18-15370	—
140	3.0L	3.0L	1998-1999	181	4	4	L010042 - L382121	V-BELT	18-15400	18-15370	—
140	3.0L	3.0L	1999-2010	181	4	4	L382122 & UP	V-BELT	—	18-15370	—
140	3.0L	3.0LX	1990-1995	181	4	4	C856559 - F603999	V-BELT	18-15410 <b>19</b>	— —	—
140	3.0L	3.0LX	1990-1995	181	4	4	C856559 - F603999	V-BELT	18-15400 <b>18</b>	18-15370	—
140	3.0L	3.0LX	1986-1997	181	4	4	F604000 - K999999	V-BELT	18-15400	18-15370	—
140	3.0L	3.0L MPI	2008-2010	181	4	4	A072812 & UP	V-BELT	—	18-15370	—
150		150	1964-66	224	4	4	1686495-2048646	V-BELT	18-15410	— —	—
160		160	1967-69	224	4	4	2048022-2770031	V-BELT	18-15410	— —	—
165		165	1987	224	4	4	B434941 - B774251	V-BELT	—	18-15410	—
165		165	1970-73	224	4	4	2770032 - 3774864	V-BELT	18-15410	— —	—
165		165	1974-81	224	4	4	3774865 - 5813433	V-BELT	18-15410	18-15370	37" BELT
165		165	1974-81	224	4	4	3774865 - 5813433	V-BELT	18-15410	18-15400	40" BELT
170	3.7L	165 / 170 / 180 / 190 / 3.7L	1985-89	224	4	4	6916779 - C762299	V-BELT	—	18-15410	—
170		170	1985-1986	224	4	4	6916779 - B434940	V-BELT	—	18-15410	—
170		470	1976-82	224	4	4	4208730 - 6218036	V-BELT	—	18-15405	—
170		470	1983-84	224	4	4	6218037 - 6916778	V-BELT	—	18-15410	—
170		488	1983-84	224	4	4	6170297 - 6916778	V-BELT	—	18-15410	—
175		175	1987	224	4	4	O8527955-OB773242	V-BELT	—	18-15490	—
180		180	1987	224	4	4	B436391 - B775248	V-BELT	—	18-15410	—
190		190	1985-1986	224	4	4	691779 - B436390	V-BELT	—	18-15410	—
190	3.7L	3.7L	1988-1989	224	4	4	B774252 - C762299	V-BELT	—	18-15410	—
190	3.7L	3.7LX	1988-1989	224	4	4	B775249 - C762299	V-BELT	—	18-15410	—
190		470	1983-1984	224	4	4	6218037 - 6916778	V-BELT	—	18-15410	—
190		470 MIE	1980-1981	224	4	4	5520115 - 6218036	V-BELT	—	—	18-15345
190		485	1980-1982	224	4	4	5685394 - 6218036	V-BELT	—	18-15410	—
190		488	1983-1984	224	4	4	6170297 - 6916778	V-BELT	—	18-15410	—
190		140	1963	194	6	4	1538930 - 1725960	V-BELT	18-15410	—	—
190		150	1964-1966	230	6	4	1686495 - 2048046	V-BELT	18-15410	—	—
190		160	1967-1969	250	6	4	2048022 - 2770031	V-BELT	18-15410	—	—
190		165	1970-1973	250	6	4	2770032 - 3774864	V-BELT	18-15410	—	—
190		165	1974-1981	250	6	4	3774865 - 5813433	V-BELT	18-15410	18-15370	37" BELT
190		150	1974-1981	250	6	4	3774865 - 5813433	V-BELT	18-15410	18-15400	40" BELT
190		200	1969	292	6	4	2453769 - 2712072	V-BELT	18-15410	—	—
190		185	1983-1984	229	6	4	6330183 - M6919655	V-BELT	—	18-15520	18-15345
190		175	1987	262	6	4	B527955 - B773242	V-BELT	—	18-15520	18-15345
190		185	1985-1986	262	6	4	A331455 - B527954	V-BELT	—	18-15520	18-15345
190		205	1985-1987	262	6	4	A331455 - B775129	V-BELT	—	18-15520	18-15345
190		205	1985-1991	262	6	4	A331455 - D714369	V-BELT	18-15440	18-15520	18-15345
190		205	1987	262	6	4	B527955 - OB775129	V-BELT	—	18-15490	—
190		4.3L	1988-92	262	6	4	OB773243-OD714106	V-BELT	—	18-15490	—
190		4.3L	1992-96	262	6	4	D714107 - F802999	V-BELT	18-15480	—	18-15290
190		4.3L ALPHA RWC	1996-1999	262	6	4	F803000 - L618999	SERPENTINE	18-15116	14, 21, 22	—
190		4.3L ALPHA FWC	1996-1999	262	6	4	F803000 - L618999	SERPENTINE	18-15117	14, 20, 22	—
190		4.3L 4.3L ALPHA RWC	1996-1999	262	6	4	F803000 - L618999	SERPENTINE	18-15116	15, 21	—
190		4.3L 4.3L ALPHA FWC	1996-1999	262	6	4	F803000 - L618999	SERPENTINE	18-15117	15, 20	—
190		4.3L 4.3L ALPHA RWC	1996-1999	262	6	4	F803000 - L618999	SERPENTINE	18-15113	19	—
190		4.3L 175 / 185 / 4.3L	1985-92	262	6	4	A331455 - D714106	V-BELT	18-15440	18-15520	18-15345
190		4.3L 4.3L Gen II	1992-96	262	6	4	OD714107-OF802999	V-BELT	—	18-15490	—
190		4.3L 4.3LX	1988-92	262	6	4	OB775130-OD714369	V-BELT	—	18-15490	—
190		4.3L 4.3LX Gen II	1992-96	262	6	4	OD714370-OF802999	V-BELT	—	18-15490	—
190		4.3L 4.3L BRAVO RWC	1996-1999	262	6	4	F803000 - L618999	SERPENTINE	18-15115	14, 21, 22	—
190		4.3L 4.3L BRAVO FWC	1996-1999	262	6	4	F803000 - L618999	SERPENTINE	18-15114	14 20 22	—
190		4.3L 4.3L BRAVO RWC	1996-1999	262	6	4	F803000 - L618999	SERPENTINE	18-15115	15, 21	—
190		4.3L 4.3L BRAVO FWC	1996-1999	262	6	4	F803000 - L618999	SERPENTINE	18-15114	15, 20	—
190		4.3L 4.3L BRAVO RWC	1996-1999	262	6	4	F803000 - L618999	SERPENTINE	18-15113	19	—
190		5.0L 215	1970-1972	302	8	4	2781153 - 3563181	V-BELT	18-15440	— —	—
190		5.0L 215 MIE	1970-1972	302	8	4	2781153 - 3563181	V-BELT	18-15440	— —	—
190		5.0L 225	1973-74	302	8	4	3385721 - 4166999	V-BELT	18-15440	18-15520	18-15345
190		5.0L 225 MIE	FORD	1973-74	302	8	3385721 - 4166999	V-BELT	18-15440	— —	—
190		5.0L 888	FORD	1971-1977	302	8	3108723 - 4887829	V-BELT	18-15440	28" BELT	—
190		5.0L 888	FORD	1971-1977	302	8	3108723 - 4887829	V-BELT	18-15440	30" BELT	18-15290
190		5.0L 198 MIE	1977	305	8	4	4782210 - 6218461	V-BELT	18-15460	— —	—
190		5.0L 200	1985-1987	305	8	4	6899058 - B774444	V-BELT	— <b>9</b>	18-15520 <b>9</b>	18-15345
190		5.0L 200	1985-1987	305	8	4	6899058 - B774444	V-BELT	18-15460	11	18-15345
190		5.0L 200	1987	305	8	4	2453769 - 2712072	V-BELT	18-15410	—	—
190		5.0L 200	1987	305	8	4	B525982-B774444	V-BELT	—	18-15490	—
190		225 MCM / 225 MIE	1967-69	305	8	4	2278847 - 2694014	V-BELT	18-15460	—	—
190		5.0L 228	1977-1982	305	8	4	4765100-6218461	V-BELT	18-15460	17	18-15325
190		5.0L 228	1977-1982	305	8	4	4765100-6218461	V-BELT	18-15440	16	18-15345
190		5.0L 228	1983-1984	305	8	4	6218462 - 6892668	V-BELT	—	9	18-15520
190		5.0L 228	1983-1984	305	8	4	6218462 - 6892668	V-BELT	18-15460	11	18-15345
190		5.0L 228 MIE	1977	305	8	4	4765100 - 4929029	V-BELT	18-15460	—	18-15345
190		5.0L 228 MIE	1978-1980	305	8	4	4929030 - 5907057	V-BELT	—	9	18-15345
190		5.0L 228 MIE	1978-1980	305	8	4	4929030 - 5907057	V-BELT	18-15460	11	18-15290
190		5.0L 228 MIE	1977	305	8	4	4765100 - 4929030	V-BELT	18-15460	—	18-15325
190		5.0L 228 / 230 / 5.0L	1983-95	305	8	4	6218462 - F600999	V-BELT	18-15440	18-15495	18-15345
190		5.0L 228 / 230 / 5.0L	1983-95	305	8	4	6218462 - F600999	V-BELT	18-15460	18-15520	18-15290
190		5.0L 228 / 230 / 5.0L MIE	1978-87	305	8	4	4929030 - B788151	V-BELT	18-15440	18-15495	18-15345
190		5.0L 228 / 230 / 5.0L MIE	1978-87	305	8	4	4929030 - B788151	V-BELT	18-15460	18-15520	18-15290
190		5.0L 230	1985-1987	305	8	4	6899269 - B773739	V-BELT	18-15520	9	18-15345
190		5.0L 230	1983-1984	305	8	4	6899269 - B773739	V-BELT	18-15460	11	18-15345
190		5.0L 230 MIE	1981-1987	305	8	4	5907058 - B788151	V-BELT	—	9	18-15345
190		5.0L 230 MIE	1981-1987	305	8	4	5907058 - B788151	V-BELT	18-15460	11	18-15290
190		230	1987	305	8	4	B525982-B773739	V-BELT	—	18-15490	—

- (1) 1/2" wide (13mm) belt
- (2) 3/8" wide (10mm) belt
- (3) 28" wide (711mm) belt
- (4) 30" wide (762mm) belt
- (5) 37" wide (940mm) belt
- (6) 40" wide (1016mm) belt
- (7) 50" wide (1270mm) belt
- (8) 55" wide (1397mm) belt

# V-BELT APPLICATION

HP	Liter	Model	Years	CID	# Cyl	Stroke	Serial #	Type of Belt	Alternator/ Water Pump	Power Steering	Sea Water Pump
		233	1975-77		4		4173000 - 4902304	V-BELT	18-15440	—	—
		233	1975-77		4		4173000 - 4902304	V-BELT	18-15440	18-15290	18-15345 12
		233 MIE	1975-76		4		4173000 - 4775784	V-BELT	18-15440	—	—
	5.0L	5.0L	1988-1995	305	8	4	B774445 - F600999	V-BELT	—	9	18-15520 9 18-15345 12
	5.0L	5.0L	1988-1995	305	8	4	B774445 - F600999	V-BELT	18-15460	11	18-15490 11 18-15290 13
	5.0L	5.0L ALPHA RWC	1998-1999	305	8	4	L012052 - L618999	SERPENTINE	18-15116	1, 14, 21, 22	—
	5.0L	5.0L ALPHA FWC	1998-1999	305	8	4	L012052 - L618999	SERPENTINE	18-15114	14, 20, 22	—
	5.0L	5.0L ALPHA RWC	1998-1999	305	8	4	L012052 - L618999	SERPENTINE	18-15116	15, 21	—
	5.0L	5.0L ALPHA FWC	1998-1999	305	8	4	L012052 - L618999	SERPENTINE	18-15114	15, 20	—
	5.0L	5.0L BRAVO RWC	1998-1999	305	8	4	L012052 - L618999	SERPENTINE	18-15115	1, 14, 20, 22	—
	5.0L	5.0L BRAVO FWC	1998-1999	305	8	4	L012052 - L618999	SERPENTINE	18-15114	1, 14, 21, 22	—
	5.0L	5.0L BRAVO RWC	1998-1999	305	8	4	L012052 - L618999	SERPENTINE	18-15115	15, 21	—
	5.0L	5.0L BRAVO FWC	1998-1999	305	8	4	L012052 - L618999	SERPENTINE	18-15114	15, 20	—
	5.0L	5.0L MIE	1988	305	8	4	B788152 - C396832	V-BELT	18-15460	11	—
	5.0L	5.0LX	1988	305	8	4	6218462 - F600999	V-BELT	—	9	18-15520 9 57-74271Q 12
	5.0L	5.0LX	1983-1995	305	8	4	6218462 - F600999	V-BELT	18-15460	11	18-15490 11 57-13457Q 13
	5.0L	5.0L	1988-95		4	4	B774445-F600999	V-BELT	—	—	—
	5.0L	5.0LX	1988-95		4	4	B773740-F600999	V-BELT	—	—	—
	5.0L	898	1977-19884	305	8	4	4782210 - 6218461	V-BELT	18-15460	17	18-15325 17 18-15345
	5.0L	898	1977-1984	305	8	4	4782210 - 6218461	V-BELT	18-15440	17	18-15495
	5.0L	898	1983-1984	305	8	4	6218462 - 6899057	V-BELT	—	9	18-15520 9 18-15345 9
	5.0L	898	1983-1984	305	8	4	6218462 - 6899057	V-BELT	18-15460	11	18-15490 11 18-15345
	5.0L	898 / 200 / 5.0L	1985-1995	305	8	4	6218462 - F600999	V-BELT	18-15440	20	18-15495 18-15345
	5.0L	898 / 200 / 5.0L	1985-1995	305	8	4	6218462 - F600999	V-BELT	18-15460	21	18-15520 18-15290
	5.7L	250 MCM / 250 MIE	1968-69	350	8	4	2314301 - 2639854	V-BELT	18-15460	—	—
	5.7L	250	1977	350	8	4	4788000 - 4908489	V-BELT	18-15440	—	18-15345
	5.7L	255 MCM / 255 MIE	1973-74	350	8	4	3258728 - 4175499	V-BELT	18-15440	—	—
	5.7L	255	GM 1975-76	350	8	4	4175500 - 4498700	V-BELT	18-15460	18-15300	18-15345
	5.7L	255	GM 1976	350	8	4	4498701-4499060	V-BELT	18-15460	—	18-15345
	5.7L	255	GM 1976	350	8	4	4499061-4767999	V-BELT	18-15460	—	18-15345
	5.7L	255 MIE	GM 1975-77	350	8	4	4175500 - 4498700	V-BELT	18-15460	—	18-15345
	5.7L	255 MIE	GM 1977-78	350	8	4	4498701 - 4924564	V-BELT	18-15460	—	18-15345
	5.7L	255 MIE	GM 1978-1980	350	8	4	4924565 - 5907057	V-BELT	—	—	18-15345
	5.7L	260 MIE	1978-86	350	8	4	4924565 - B522505	V-BELT	18-15440	—	18-15345
	5.7L	260 / 5.7L MIE / 5.7L Ski	1987-93	350	8	4	B522506 - F024999	V-BELT	18-15440	—	18-15345 12
	5.7L	260 / 5.7L MIE / 5.7L Ski	1987-93	350	8	4	B522506 - F024999	V-BELT	18-15460	16	18-15290 13
	5.7L	260	1978-1982	350	8	4	4908850 - 6218461	V-BELT	18-15440	16	18-15495 17 18-15345
	5.7L	260	1978-1982	350	8	4	4908850 - 6218461	V-BELT	18-15460	17	18-15345
	5.7L	260	1987	350	8	4	B525982-B773304	V-BELT	—	—	18-15490
	5.7L	260	1983-1987	350	8	4	6218462 - B773304	V-BELT	18-15460	11	18-15490 11 18-15290 13
	5.7L	260 MIE	1987	350	8	4	B522506 - B788151	V-BELT	18-15460	11	—
	5.7L	260 / 5.7L	1983-1995	350	8	4	6218462 - F600999	V-BELT	18-15440	—	18-15290 13
	5.7L	260 / 5.7L	1983-1995	350	8	4	6218462 - F600999	V-BELT	18-15460	—	18-15495 18-15345 20
	5.7L	260 / 5.7L	1983-1995	350	8	4	6218462 - F600999	V-BELT	18-15460	—	18-15520 18-15290 21
	5.7L	270 MCM / 270 MIE	1969-1972	350	8	4	2851074 - 3385720	V-BELT	18-15460	—	—
	5.7L	280 TRS	1975	350	8	4	4178250 - 4178468	V-BELT	18-15460	—	—
	5.7L	280 TRS	1975	350	8	4	4178250 - 4178468	V-BELT	18-15460	18-15300	—
	5.7L	280 TRS	1975-76	350	8	4	4178469 - 4499390	V-BELT	18-15460	—	18-15300
	5.7L	280 TRS	1976	350	8	4	4499391 - 4499780	V-BELT	18-15460	—	—
	5.7L	280 TRS	1976	350	8	4	4499781 - 4770199	V-BELT	18-15460	—	18-15325
		320 EFI	1987-89		8	4	A543804 - C622418	V-BELT	18-15440	18-15520	—
		330	1977-81		8	4	4623115-6083144	—	18-15470	—	18-15345
		330	1982-87		8	4	6083144 - B816540	—	18-15470	—	18-15500
		330	1982-87		8	4	6083144 - B816540	—	18-15470	—	18-15500 12
		330	1982-87		8	4	6083144 - B816540	—	18-15470	—	18-15550 18-15290 13
	5.7L	350 MAG ALPHA	1986-1995	350	8	4	A635178 - F600999	V-BELT	18-15440	9	18-15520 9 18-15345 20
	5.7L	350 MAG ALPHA	1986-1995	350	8	4	A635178 - F600999	V-BELT	18-15460	11	18-15490 11 18-15290 21
	5.7L	350 MAG ALPHA	1996	350	8	4	F601000 - K001500	V-BELT	18-15460	—	18-15490
	5.7L	350 Mag Alpha	1987-1995	350	8	4	B525982 - F600999	V-BELT	—	—	18-15490
	5.7L	350 Mag Alpha	1996	350	8	4	F601000 - K001526	V-BELT	—	—	18-15490
	5.7L	350 Mag Alpha EFI / 350 Mag ALPHA Gen+	1996	350	8	4	F800300 - K001508	V-BELT	—	—	18-15490
	5.7L	350 Mag Bravo MPI	1995	350	8	4	F415189 - F601999	V-BELT	—	—	18-15490
		350 Mag Bravo MPI Gen+	1996	350	8	4	F602000 - K001500	V-BELT	—	—	18-15490
	5.7L	350 MAG SKI	1991-96	350	8	4	D505450 - K040005	V-BELT	18-15460	—	—
	5.7L	350 MAG ALPHA RWC	1997-1999	350	8	4	K001501 - L618999	SERPENTINE	18-15116	14, 21, 22	—
	5.7L	350 MAG ALPHA FWC	1997-1999	350	8	4	K001501 - L618999	SERPENTINE	18-15114	14, 20, 22	—
	5.7L	350 MAG ALPHA RWC	1997-1999	350	8	4	K001501 - L618999	SERPENTINE	18-15116	15, 20	—
	5.7L	350 MAG ALPHA FWC	1997-1999	350	8	4	K001501 - L618999	SERPENTINE	18-15114	15, 21	—
	5.7L	350 MAG BRAVO RWC	1997-1999	350	8	4	K001501 - L618999	SERPENTINE	18-15115	14, 21, 22	—
	5.7L	350 MAG BRAVO FWC	1997-1999	350	8	4	K001501 - L618999	SERPENTINE	18-15114	14, 20, 22	—
	5.7L	350 MAG BRAVO RWC	1997-1999	350	8	4	K001501 - L618999	SERPENTINE	18-15115	15, 21	—
	5.7L	350 MAG BRAVO FWC	1997-1999	350	8	4	K001501 - L618999	SERPENTINE	18-15114	15, 20	—
	5.7L	350 MIE	1974-75	350	8	4	3780450-4501640	—	18-15480	—	—
	5.7L	350 MIE	1976	350	8	4	4501641 - 4623109	—	18-15480	—	18-15345
	5.7L	350 MAG MPI / 350 MAG SKI	1995-1996	350	8	4	F305883 - F799999	V-BELT	18-15460	—	18-15290
	5.7L	350 MAG SKI	1991-1996	350	8	4	D505450 - K040005	V-BELT	18-15460	—	18-15290 12
	5.7L	5.7L	1988-1995	350	8	4	B773305 - F600999	V-BELT	—	9	18-15520 9 18-15345
	5.7L	5.7L	1988-1995	350	8	4	B773305 - F600999	V-BELT	18-15460	11	18-15490 11 18-15290
	5.7L	5.7L	1996	350	8	4	F601000 - K001505	V-BELT	18-15460	—	18-15490 18-15290
	5.7L	5.7L ALPHA RWC	1997-1999	350	8	4	K001506 - L618999	SERPENTINE	18-15116	14, 21, 22	—
	5.7L	5.7L ALPHA FWC	1997-1999	350	8	4	K001506 - L618999	SERPENTINE	18-15114	14, 20, 22	—
	5.7L	5.7L ALPHA RWC	1997-1999	350	8	4	K001506 - L618999	SERPENTINE	18-15116	15, 21	—
	5.7L	5.7L ALPHA FWC	1997-1999	350	8	4	K001506 - L618999	SERPENTINE	18-15114	15, 20	—
	5.7L	5.7L BRAVO RWC	1997-1999	350	8	4	K001506 - L618999	SERPENTINE	18-15114	14, 20, 22	—
	5.7L	5.7L BRAVO RWC	1997-1999	350	8	4	K001506 - L618999	SERPENTINE	18-15115	15, 21	—
	5.7L	5.7L BRAVO FWC	1997-1999	350	8	4	K001506 - L618999	SERPENTINE	18-15114	15, 20	—
	5.7L	5.7L MIE	1988-1993	350	8	4	B522506 - F024999	V-BELT	—	—	18-15345
	5.7L	5.7L MIE	1988-1993	350	8	4	B522506 - F024999	V-BELT	—	—	18-15290
	5.7L	5.7L MIE	1994-1996	350	8	4	F025000 - K040306	V-BELT	18-15460	—	18-15290
	5.7L	5.7L SKI	1985-1987	350	8	4	A338553 - B514626	V-BELT	—	—	18-15290 13
	5.7L	5.7L SKI	1987-1995	350	8	4	B514627 - F775199	V-BELT	—	—	18-15345
	5.7L	5.7L SKI	1987-1995	350	8	4	B514627 - F775199	V-BELT	—	—	18-15290
	5.7L	5.7L SKI	1996	350	8	4	F775200 - K040003	V-BELT	18-15460	—	18-15290
	5.7L	5.7LX	1996	350	8	4	F601000 - K001505	V-BELT	18-15460	18-15490	18-15290
	5.7L	5.7LX BRAVO EFI	1996	350	8	4	F800300 - K001505	V-BELT	18-15460	18-15490	18-15290
	5.7L	5.7LX BRAVO	1996	350	8	4	F601000 - K001505	V-BELT	18-15460	18-15490	18-15290
	5.7L	BLACK SCORPION SKI	1996	350	8	4	F800000 - K040000	V-BELT	18-15460	—	18-15290

- |                           |  |  |
|---------------------------|--|--|
| (1) 1/2" wide (13mm) belt | (10) Use with 5 7/8" (149mm) dia water pump pulley | (19) For engines w/o power steering  |
| (2) 3/8" wide (10mm) belt | (11) Use with 7" (178mm) dia water pump pulley     | (20) For engines with closed cooling   |
| (3) 28" wide (711mm) belt | (12) Use with stamped steel sea water pump pulley  | (21) For engines with standard cooling   |
| (4) 30" wide (762mm) belt | (13) Use with cast aluminum sea water pump pulley  | (22) Replacement kit includes 5 3/4" (146mm) pulley and longer serpentine belt |
| (5) 37" wide (940mm) belt | (14) Use with plastic 4 3/4" (121mm)               |  |

V-BELT APPLICATION

Table with columns: HP, Liter, Model, Years, CID, # Cyl, Stroke, Serial #, Type of Belt, Alternator/ Water Pump, Power Steering, Sea Water Pump. Rows include various outboard motor models like 5.7L MIE, 7.4L BRAVO, and 8.2L MIE.

- (1) 1/2" wide (13mm) belt
(2) 3/8" wide (10mm) belt
(3) 28" wide (711mm) belt
(4) 30" wide (762mm) belt
(5) 37" wide (940mm) belt
(6) 40" wide (1016mm) belt
(7) 50" wide (1270mm) belt
(8) 55" wide (1397mm) belt
(9) Use with 5 1/2" (140mm) dia water pump pulley

- (10) Use with 5 7/8" (149mm) dia water pump pulley
(11) Use with 7" (178mm) dia water pump pulley
(12) Use with stamped steel sea water pump pulley
(13) Use with cast aluminum sea water pump pulley
(14) Use with plastic 4 3/4" (121mm) dia p/s pump pulley
(15) Use with metal 5 3/4" (146mm) dia p/s pump pulley
(16) For engine with high mounted p/s pump
(17) For engines with low mounted p/s pump
(18) For engine with power steering

- (19) For engines w/o power steering
(20) For engines with closed cooling
(21) For engines with standard cooling
(22) Replacement kit includes 5 3/4" (146mm) pulley and longer serpentine belt
(23) For engines with high mounted alternator

# SERPENTINE BELTS



## BELT INTERCHANGE

Part #	OE #	Width	Length	Part #	OE #	Width	Length
18-15100	57-863876 3	13/16	106.25	18-15114	57-861049	13/16	104.25
18-15101	57-863876 4	13/16	76.5	18-15115	57-861757	13/16	97.5
18-15102	57-863876 6	13/16	105	18-15116	57-861758	13/16	86.75
18-15103	57-863876 7, 57-865615007	13/16	96.75	18-15119	57-863876 1	13/16	111.25
18-15104	57-863876 8	13/16	99.5	18-15121	57-865615005	13/16	87.5
18-15105	57-863876 9, 57-865615009	13/16	69.75	18-15122	57-865615010	13/16	86
18-15112	57-8077554	13/16	88	18-15123	57-864639	13/16	85
				18-15125	57-817113	1-3/8	53.5

## BELT APPLICATION

Engine	Years	Serial #	Part #	Mercruiser #	Footnote	Engine	Years	Serial #	Part #	Mercruiser #	Footnote
4.3L Alpha	1996-99	OF803000-OL618999	18-15116	57-861758	2, 6	5.7L Bravo	2002-04	OM600000 & up	18-15102	57-863876 6	3, 5, 7
4.3L Alpha	2000-04	OL619000 & up	18-15101	57-863876 4	3, 6, 7	5.7L Bravo	2000-04	OL619000 & up	18-15104	57-863876 8	4, 7
4.3L Alpha	2000-04	OL619000 & up	18-15104	57-863876 8	4, 5, 7	5.7L Ski	1997-02	OK040004-OM316999	18-15112	57-8077554	
4.3L Alpha	2000-04	OL619000 & up	18-15105	57-865615009	4, 6, 7	5.7L Ski	2002-05	OM317000 & up	18-15121	57-865615005	
4.3L Bravo	1996-99	OF803000-OL618999	18-15114	57-861049	2, 5	5.7L MIE	2001-05	OL677227 & up	18-15121	57-865615005	
4.3L Bravo	1996-99	OF803000-OL618999	18-15115	57-861757	2, 6	377 Scorpion MCM	1999-04	OL416146 & up	18-15115	57-861757	
4.3L Bravo	2000-04	OL619000 & up	18-15104	57-863876 8	4, 7	377 Scorpion Ski	1997-98	OK000656 & up	18-15112	57-8077554	
5.0L Bravo	2002-04	OM600000 & up	18-15102	57-863876 6	3, 5, 7	454 Mag MPI	1998-01	OL010029-OM024999	18-15114	57-861049	1
5.0L Alpha	1998-99	OL012052-OL618999	18-15114	57-861049	5	454 Mag MPI	1998-01	OL010029-OM024999	18-15102	57-863876 6	2
5.0L Alpha	1998-99	OL012052-OL618999	18-15116	57-861758	2, 6	454 Mag MPI	1998-01	OL010029-OM024999	18-15103	57-865615007	4
5.0L Alpha	2000-04	OL619000 & up	18-15101	57-863876 4	3, 6, 7	454 Mag MPI Horizon MIE	1998-01	OL002200-OL674000	18-15103	57-865615007	
5.0L Alpha	2002-04	OM600000 & up	18-15102	57-863876 6	3, 5, 7	496 Mag & HO	2000-04	OM025000 & up	18-15119	57-863876 1	
5.0L Alpha	2001-04	OL619000 & up	18-15104	57-863876 8	4, 5, 7	500 EFI	1999-04	OL001477 & up	18-15112	57-8077554	
5.0L Alpha	2000-04	OL619000 & up	18-15105	57-865615009	4, 6, 7	502 Mag MPI	1998-01	OL017000-OM024999	18-15114	57-861049	1
5.0L Bravo	1998-99	OL012052-OL618999	18-15114	57-861049	2, 5	502 Mag MPI	1998-01	OL017000-OM024999	18-15103	57-865615007	4
5.0L Bravo	1998-99	OL012052-OL618999	18-15115	57-861757	2, 6	502 Mag. MPI	1998-01	OL017000-OM024999	18-15102	57-863876 6	2
5.0L Bravo	2000-04	OL619000 & up	18-15104	57-863876 8	4, 7	525 SC	1991-96	OD456000-745215	18-15125	57-817113	
350 Mag, Alpha	1997-04	OK001501-OL618999	18-15114	57-861049	2, 5	575 Sci	2000-05	OL306696 & up	18-15125	57-817113	8
350 Mag, Alpha	1997-04	OK001501-OL618999	18-15116	57-861758	2, 6	575 Sci	2000-05	OL306696 & up	18-15112	57-8077554	9
350 Mag, Alpha	2000-04	OL619000 & up	18-15103	57-865615007	3, 6, 7	600 SC	1991-96	OD456489-OF877462	18-15125	57-817113	
350 Mag, Alpha	2002-04	OM600000 & up	18-15102	57-863876 6	3, 5, 7	600 SC	1998	OK000227 & up	18-15125	57-817113	
350 Mag, Alpha	2000-04	OL619000 & up	18-15104	57-863876 8	4, 5, 7	7.4L MPI	1998-01	OL010003-OM024330	18-15114	57-861049	1
350 Mag, Alpha	2000-04	OL619000 & up	18-15105	57-865615009	4, 6, 7	7.4L MPI	1998-01	OL010003-OM024330	18-15102	57-863876 6	2
350 Mag, Bravo	1997-04	OK001501-OL618999	18-15114	57-861049	2, 5	7.4L MPI	1998-01	OL010003-OM024330	18-15103	57-865615007	4
350 Mag, Bravo	1997-04	OK001501-OL618999	18-15115	57-861757	2, 6	7.4L MPI MIE	1998-01	OL002006-OM025999	18-15103	57-865615007	
350 Mag, Bravo	2002-04	OM600000 & up	18-15102	57-863876 6	3, 5, 7	Black Scorpion Ski	1997-01	OK040001-OM391599	18-15112	57-8077554	
350 Mag, Bravo	2000-04	OL619000 & up	18-15104	57-863876 8	4, 7	Black Scorpion Ski	2003-05	OM391600 & up	18-15121	57-865615005	
350 Mag MPI MIE	2001-05	OL678399-up	18-15121	57-865615005	6	MX 6.2L Bk Scorpion Ski	2001	OL670015-OM391599	18-15112	57-8077554	
350 Mag MPI MIE	2002-05	OM317000 & up	18-15122	57-865615010	5	MX 6.2L MPI	2002-04	OM600000 & up	18-15102	57-863876 6	3, 5
350 Mag MPI Ski	2001-05	OM300000 & up	18-15121	57-865615005		MX 6.2L MPI	2000-04	OL680003 & up	18-15104	57-863876 8	4, 7
350 Mag MPI Horizon MIE	2001-02	OL678399-OM316999	18-15121	57-865615005		MX 6.2L MPI Horizon	2002-04	OM600000 & up	18-15102	57-863876 6	3
350 Mag MPI Horizon MIE	2001-05	OM317000 & up	18-15122	57-865615010		MX 6.2L MPI Horizon	2001-04	OM300000 & up	18-15104	57-863876 8	4
5.7L Alpha	1997-99	OK001501-OL618999	18-15114	57-861049	2, 5	MX 6.2L MPI Horizon MIE	2001	OM300000-OM310099	18-15112	57-8077554	
5.7L Alpha	1997-99	OK001506-OL618999	18-15116	57-861758	2, 6	MX 6.2L MPI Horizon MIE	2001-05	OM310100 & up	18-15121	57-865615005	6
5.7L Alpha	2000-04	OL619000 & up	18-15101	57-863876 4	3, 6, 7	MX 6.2L MPI Horizon MIE	2002-05	OM317000 & up	18-15122	57-865615010	5
5.7L Alpha	2002-04	OM600000 & up	18-15102	57-863876 6	3, 5, 7	MX 6.2L MPI MIE	1999-01	OL670000-OM310099	18-15112	57-8077554	
5.7L Alpha	2000-04	OL619000 & up	18-15104	57-863876 8	4, 5, 7	MX 6.2L MPI MIE	2001-05	OM310100 & up	18-15121	57-865615005	6
5.7L Alpha	2000-05	OL619000 & up	18-15105	57-865615009	4, 6, 7	MX 6.2L MPI MIE	2002-05	OM317000 & up	18-15122	57-865615010	5
5.7L Bravo	1997-99	OK001506-OL618999	18-15114	57-861049	2, 5	MX 6.2L MPI Ski	2002-05	OM317000 & up	18-15121	57-865615005	
5.7L Bravo	1997-99	OK001506-OL618999	18-15115	57-861757	2, 6	8.2L MPI MIE	1998-01	OL002450-OL674200	18-15103	57-865615007	

### Footnote

- 1: Use with plastic 4-3/4" dia. p/s pump pulley
- 2: Use with metal 5-3/4" dia. p/s pump pulley
- 3: For engines with power steering

- 4: For engines without power steering
- 5: For engines with closed cooling
- 6: For engines with standard cooling

- 7: Engines with high mounted alternators
- 8: Blower
- 9: Alternator

### Fits GM Big Block V8 454 cu. in. Models 330, 340 & 7.4L

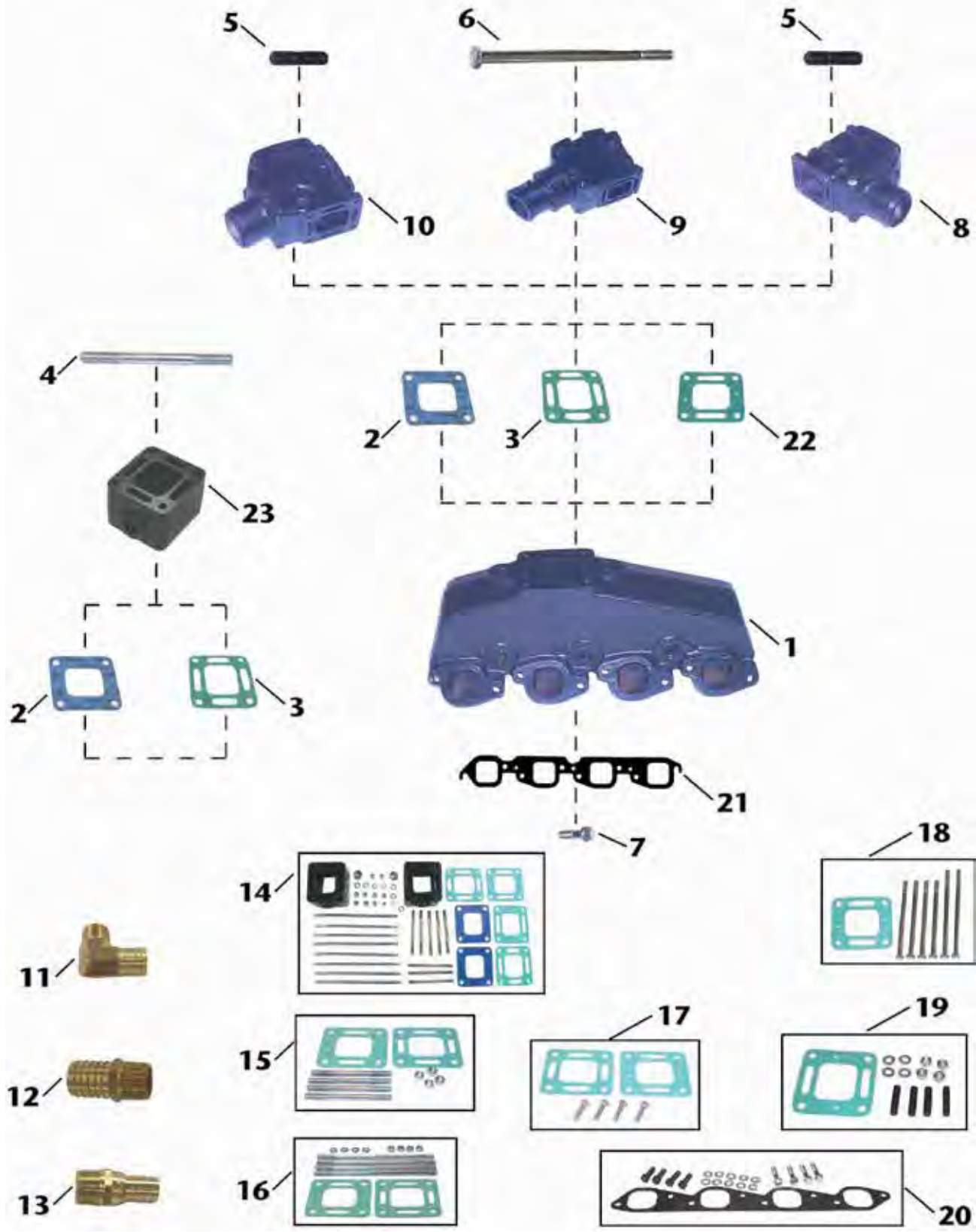

Item No	Description	OE No.	Application
1	18-1957-1 MANIFOLD	807078A6	GM Big Block (V8) 454 cu.in. Models 330, 340 & 7.4L. Use with 18-0418 manifold gasket; Mounting Kit: 18-8532
2	18-0672 ELBOW GASKET (BLOCKED)	27-860231	Fits Manifold: 18-1957-1; Elbows: 18-1970-1, & 18-1976-1, 18-1974: Spacer 18-1908.
3	18-2849 ELBOW GASKET (OPEN)	27-818832	Fits Manifold: 18-1957-1; Elbows: 18-1970-1, & 18-1976-1, 18-1974: Spacer 18-1908.
4	NSS MOUNTING STUD	N/A	Included in 18-8554 mounting kit.
5	NSS MOUNTING STUD	N/A	Included in 18-8529 mounting kit.
6	NSS MOUNTING BOLT	N/A	Included in 18-8505 mounting kit.
7	NSS MOUNTING BOLT	N/A	Included in 18-8532 mounting kit.
8	18-1974-1 MANIFOLD ELBOW	98502A2	Fits Manifold: 18-1957-1. Use Elbow gaskets: 18-2849, 18-0897, or 18-0672; Use mounting kit: 18-8529 (Do not use with spacer)
9	18-1976-1 MANIFOLD ELBOW	44354A3	Fits Manifold: 18-1957-1. Use Elbow gaskets: 18-2849, 18-0897, or 18-0672; Use mounting kit: 18-8505, or if spacer is included use 18-8555
10	18-1970-1 MANIFOLD ELBOW	98504A3	Fits Manifold: 18-1957-1. Use Elbow gaskets: 18-2849, 18-0897, or 18-0672; Use mounting kit: 18-8529, or if spacer is included use 18-8554.
11	18-8216 HOSE FITTING	N/A	3/4" - 14NPT X 1" Hose (Corrosion Resistant Brass Fitting)
12	18-4461 HOSE FITTING	N/A	3/4" - 14NPT X 1" Hose (Corrosion Resistant Brass Fitting)
13	18-8215 HOSE FITTING	N/A	3/4" - 14NPT X 3/4" Hose (Corrosion Resistant Brass Fitting)
14	18-1908K MANIFOLD SPACER KIT	807476A6, 93320A5	3" Riser Kit for Manifold: 18-1957-1. Includes (2) spacers, restrictor, open, & blocked gasket. All necessary mounting hardware is also included.
15	18-8554 MOUNTING KIT	N/A	Use 18-8554 Mounting Kit when 18-1908 Spacer, 18-1970-1 Elbow and 18-1974 Elbow are used together. Included in 18-1908K. Includes (1) 18-2849 & 18-0897 elbow gaskets.
16	18-8555 MOUNTING KIT	N/A	Use with Manifold Spacer: 18-1908 with Riser 18-1976-1. Included in 18-1908K. Includes (1) 18-2849 & 18-0897 elbow gaskets.
17	18-8556 MOUNTING KIT	N/A	Use with Manifold Spacer: 18-1985. Includes (1) 18-2849 & 18-0897 elbow gaskets
18	18-8505 MOUNTING KIT	N/A	Use with Riser: 18-1976-1. Includes 18-0897 elbow gasket.
19	18-8529 MOUNTING KIT	N/A	Use with Risers: 18-1970-1 & 18-1974-1. Includes 18-0897 elbow gasket.
20	18-8532 MOUNTING KIT	N/A	Use with Manifold: 18-1957-1. Includes 18-0418 manifold gasket.
21	18-0418 MANIFOLD GASKET	96653 / 27-46820	Use with Manifold: 18-1957-1. Included in 18-8532 mounting kit.
22	18-0897 ELBOW GASKET (RESTRICTOR)	27-41813	Fits Manifold: 18-1957-1; Manifold Spacers: 18-1985, & 18-1908; Elbows: 18-1970-1, & 18-1976-1, 18-1974
23	18-1908 MANIFOLD SPACER	93322A12	3" Spacer for Manifold: 18-1952-1. Use with mounting kit 18-8556. (Note: To mount elbows to spacer a separate mounting kit is needed)

### Fits GM In-Line 6 Cylinder 250 & 292 cu. in. Models 165 & 200

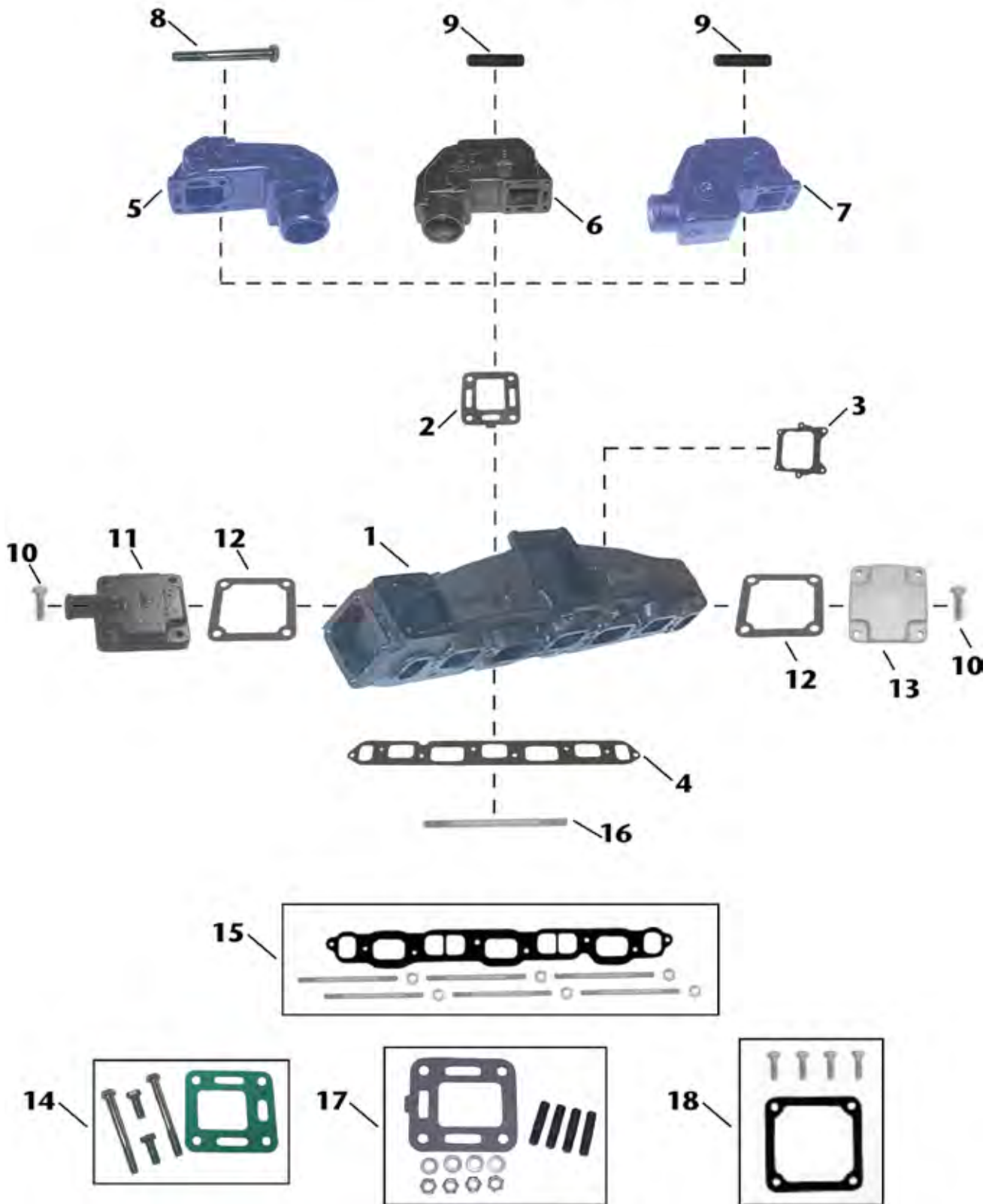



Item No	Description	OE No.	Application
1	18-1960-1 MANIFOLD	58759A10	GM In-Line Six Cylinder 250 & 292 cu.in. Models 165 & 200. Use with 18-2830 manifold gasket; 18-8531 Mounting Kit
2	18-2833 ELBOW GASKET	27-99777-2	Use with Elbows: 18-1971, 18-1978 & 18-1972. Included in 18-4362 mounting kit.
3	18-0353 CARBURETOR GASKET	27-58764	Fits Manifold: 18-1960-1
4	18-2830 MANIFOLD GASKET	27-46401	Fits Manifold: 18-1960-1. Included in 18-8531 mounting kit.
5	18-1972 MANIFOLD ELBOW	76325A2	Use with Manifold: 18-1960-1; Elbow Gasket 18-2833
6	18-1971 MANIFOLD ELBOW	76351A2	Use with Manifold: 18-1960-1; Elbow Gasket 18-2833; Mounting Kit 18-4362.
7	18-1978 MANIFOLD ELBOW	76771A3	Use with Manifold: 18-1960-1; Elbow Gasket 18-2833; Mounting Kit 18-4362.
8	NSS MOUNTING BOLT	N/A	Included in 18-8552 mounting hardware.
9	18-3233 MOUNTING STUD	16-49545	3/8-24, 3/8-16 X 1 3/4. Included in 18-4362 mounting kit.
10	NSS MOUNTING BOLT	N/A	Included in 18-8512 mounting kit.
11	18-4009 FRONT PLATE	60252A2	Fits Manifold: 18-1960-1
12	18-2832 FRONT/END PLATE GASKET	27-48043-1	Fits Port & Starboard Caps of Manifold: 18-1960-1. Included in 18-8512 mounting kit.
13	NSS END PLATE	N/A	Fits Manifold: 18-1960-1
14	18-8552 HARDWARE KIT	N/A	Includes only hardware for 18-1972 elbow.
15	18-8531 MOUNTING KIT	N/A	Use with Manifold: 18-1960-1. Includes 18-2830 manifold gasket.
16	NSS MOUNTING STUD	N/A	Included in 18-8531 mounting kit.
17	18-4362 MOUNTING KIT	N/A	Use with Elbows: 18-1971 & 18-1978. Includes 18-2833 elbow gasket.
18	18-8512 MOUNTING KIT	N/A	Use with Front Plate: 18-4009. Includes 18-2832 gasket.



### Fits GM V6 229 & 262 cu. in. Models 185 & 205

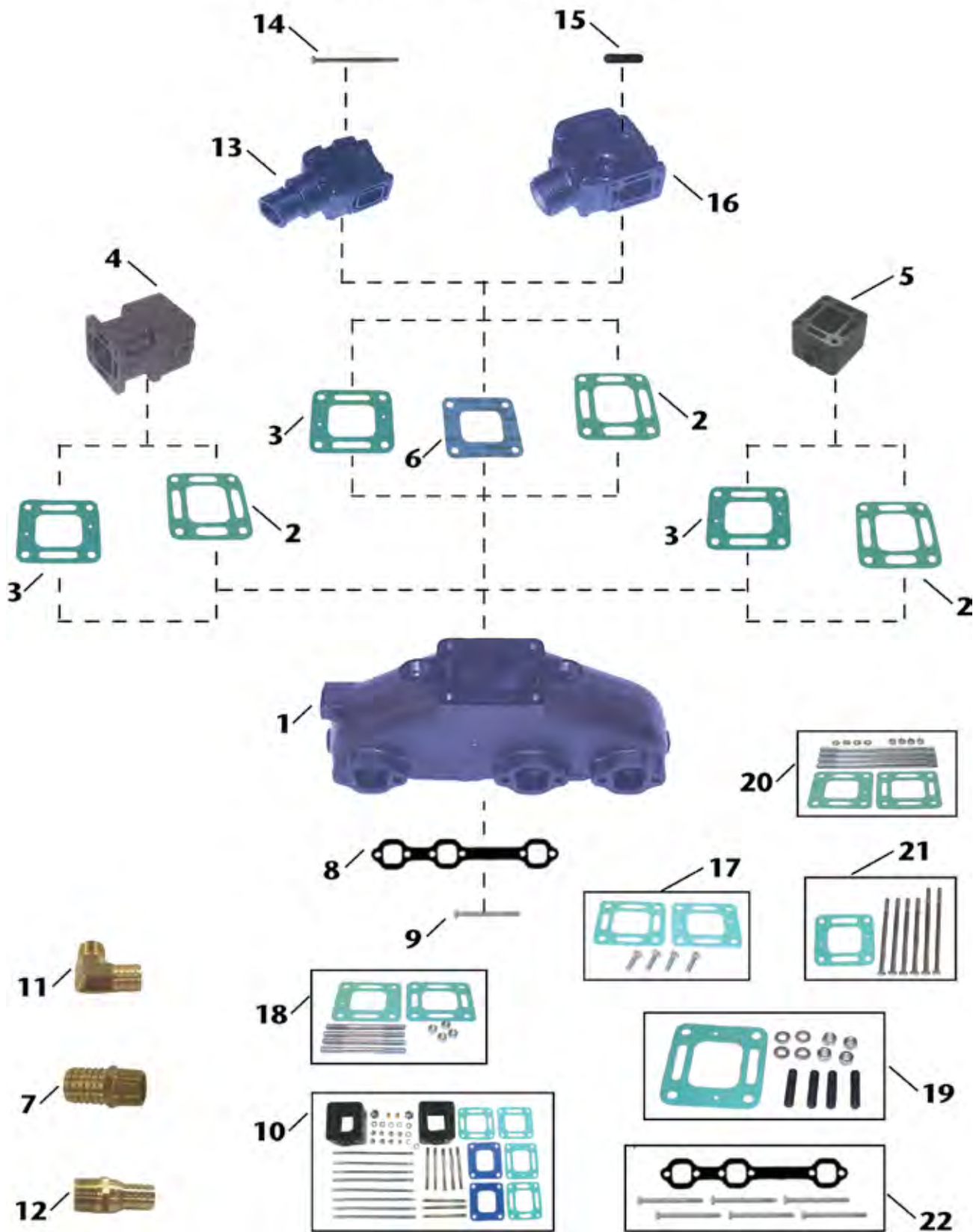

	<b>Item No</b>	<b>Description</b>	<b>OE No.</b>	<b>Application</b>
1	18-1952-1	MANIFOLD	99746A8	GM (V6) 229 & 262 cu.in. Models 185 & 205 (Port & Starboard). Use with Manifold Gasket: 18-2909; Mounting Kit: 18-8533
2	18-2849	ELBOW GASKET (OPEN)	27-818832	Fits Manifold: 18-1952-1; Manifold Spacers: 18-1985, & 18-1908; Elbows: 18-1970-1, & 18-1976-1
3	18-0897	ELBOW GASKET (RESTRICTOR)	27-41813	Fits Manifold: 18-1952-1; Manifold Spacers: 18-1985, & 18-1908; Elbows: 18-1970-1, & 18-1976-1
4	18-1985	MANIFOLD SPACER	93322A12	6" Spacer for Manifold: 18-1952-1. Use with mounting kit 18-8556. (Note: To mount elbows to spacer a separate mounting kit is required)
5	18-1908	MANIFOLD SPACER	933220	3" Spacer for Manifold: 18-1952-1. Use with mounting kit 18-8555 with 18-1976-1, or mounting kit 18-8554 with 18-1970-1.
6	18-0672	ELBOW GASKET (BLOCKED)	27-860231	Fits Manifold: 18-1952-1; Elbows: 18-1970-1, & 18-1976-1
7	18-4461	HOSE FITTING	N/A	3/4" - 14NPT X 1" Hose (Corrosion Resistant Brass Fitting)
8	18-2909	MANIFOLD GASKET	N/A	Gasket for Manifold: 18-1952-1. Included in 18-8533 mounting kit.
9	NSS	MOUNTING BOLT	N/A	Included in 18-8533 mounting kit.
10	18-1908K	MANIFOLD SPACER KIT	807476A6, 93320A5	3" Riser Kit for Manifold: 18-1952-1. Includes (2) spacers, restrictor, open, & blocked gasket. All necessary mounting hardware is also included.
11	18-8216	HOSE FITTING	N/A	3/4" - 14NPT X 1" Hose (Corrosion Resistant Brass Fitting)
12	18-8215	HOSE FITTING	N/A	3/4" - 14NPT X 3/4" Hose (Corrosion Resistant Brass Fitting)
13	18-1976-1	MANIFOLD ELBOW	44354A3, 807914A1	Fits Manifold: 18-1952-1. Use Elbow gaskets: 18-2849. 18-0897, or 18-0672; Use mounting kit: 18-8554
14	NSS	MOUNTING BOLT	N/A	Included in 18-8505 mounting kit.
15	NSS	MOUNTING STUD	N/A	Included in 18-8529 mounting kit.
16	18-1970-1	MANIFOLD ELBOW	98504A3	Fits Manifold: 18-1952-1. Use Elbow gaskets: 18-2849. 18-0897, or 18-0672; Use mounting kit: 18-8529, or if spacer is included use 18-8555.
17	18-8556	MOUNTING KIT	N/A	Use with Manifold Spacer: 18-1985. Includes (1) 18-2849 & 18-0897
18	18-8554	MOUNTING KIT	N/A	Use with Manifold Spacer: 18-1908 with Riser 18-1970-1. Included in 18-1908K. Includes (1) 18-2849 & 18-0897 elbow gaskets.
19	18-8529	MOUNTING KIT	N/A	Use with Riser: 18-1970-1. Includes 18-0897 elbow gaskets.
20	18-8555	MOUNTING KIT	N/A	Use with Manifold Spacer: 18-1908 with Riser 18-1976-1. Included in 18-1908K. Includes (1) 18-2849 & 18-0897 elbow gasket.
21	18-8505	MOUNTING KIT	N/A	Use with Riser: 18-1976-1. Includes 18-0897 elbow gasket.
22	18-8533	MOUNTING KIT	N/A	Use with Manifold: 18-1952-1. Includes 18-2909 manifold gasket.

### Fits GM Small Block V8 305-350 cu. in. Models 198, 228 & 898

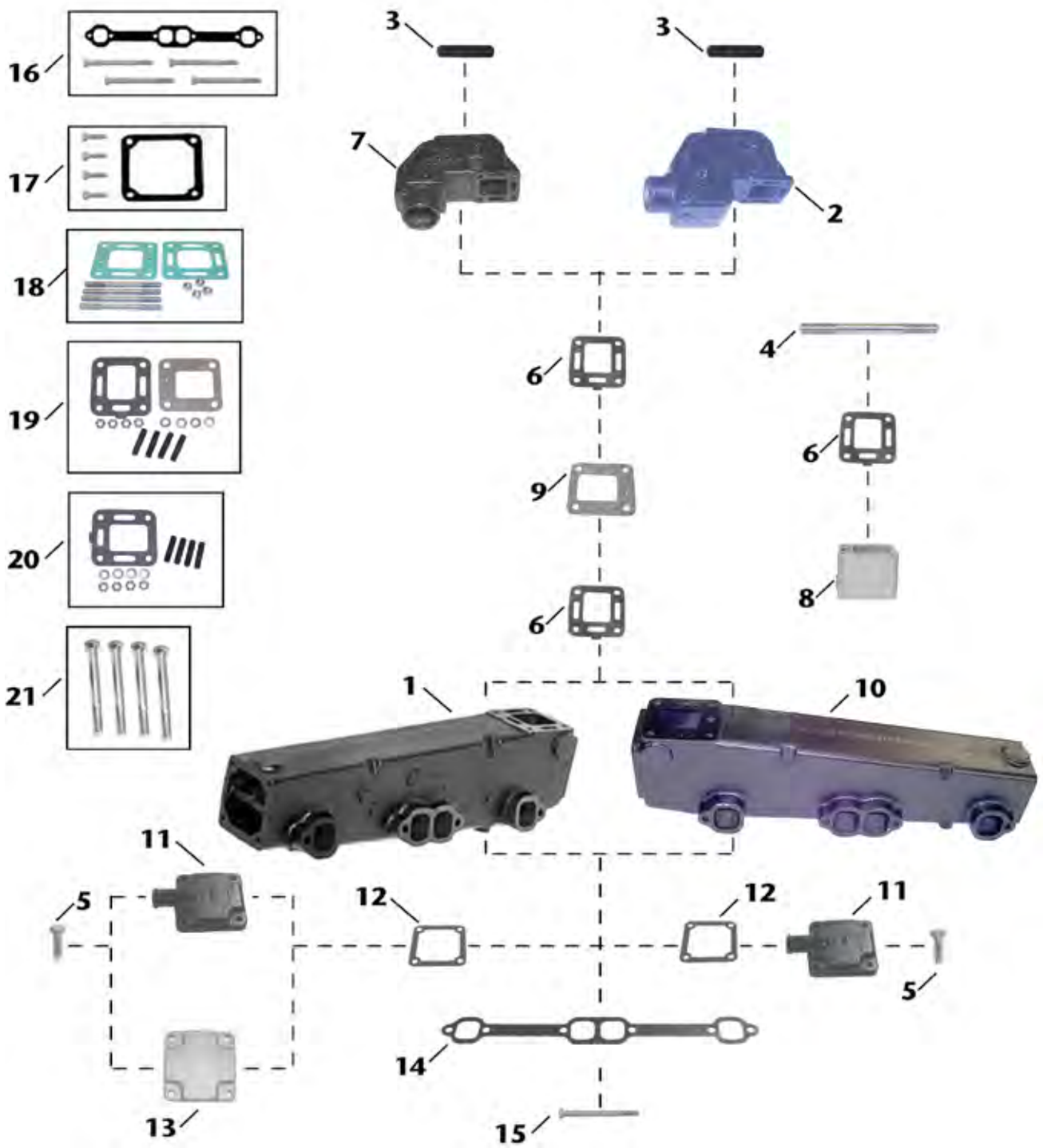

	<b>Item No</b>	<b>Description</b>	<b>OE No.</b>	<b>Application</b>
	1	18-1951-1 MANIFOLD (STARBOARD)	774235A2	GM Small Block (V8) 305-350 cu.in. Models 198, 228, & 898. (Starboard)
	2	18-1978 MANIFOLD ELBOW	76771A3	Use with Manifolds: 18-1950-1, 18-1951-1; Elbow Gasket 18-2833; Mounting Kit 18-4362.
	3	18-3233 MOUNTING STUD	16-49545	3/8-24, 3/8-16 X 1 3/4. Included in 18-4362 mounting kit.
	4	NSS MOUNTING STUD	N/A	Included in 18-8554 mounting kit.
	5	NSS MOUNTING BOLT	N/A	Included in 18-8512 mounting kit.
	6	18-2833 ELBOW GASKET	27-99777-2	Use with Elbows: 18-1971 & 18-1978. Included in 18-4362 mounting kit.
	7	18-1971 MANIFOLD ELBOW	76351A2	Use with Manifolds: 18-1950-1, 18-1951-1; Elbow Gasket 18-2833; Mounting Kit 18-4362.
	8	18-1906 MANIFOLD SPACER	61851	3" Spacer for Manifold: 18-1950-1, 18-1951-1. Use with mounting kit 18-8554 with 18-1971 or 18-1978 Elbows.
	9	18-4008 BLOCK OFF PLATE	60207	Use with Manifolds 18-1950-1, 18-1951-1. Requires (2) 18-2833 elbow gaskets
	10	18-1950-1 MANIFOLD (PORT)	77234A2	GM Small Block (V8) 305-350 cu.in. Models 198, 228, & 898. (Port)
	11	18-4009 END PLATE	60252A2	Use with (Port & Starboard) Manifolds: 18-1950-1 & 18-1951-1; Mounting Kit: 18-8512
	12	18-2832 FRONT/END PLATE GASKET	27-48043-1	Fits Port & Starboard Caps of Manifolds: 18-1950-1, 18-1951-1. Use with Front Plate: 18-4009. Included in 18-8512 mounting kit.
	13	NSS END PLATE	54870	Fits Manifold: 18-1950-1, 18-1951-1; Mounting Kit: 18-8512.
	14	18-2949 MANIFOLD GASKET	96306	Use with Manifold: 18-1951-1
	15	NSS MOUNTING BOLT	N/A	Included in 18-8520 mounting kit.
	16	18-8520 MOUNTING KIT	N/A	Use with Manifolds: 18-1950-1, 18-1951-1. Includes 18-2949 manifold gasket.
	17	18-8512 MOUNTING KIT	N/A	Use with Front/End Plates: 18-4009. Includes 18-2832 front end plate gasket
	18	18-8554 MOUNTING KIT	N/A	Use with Manifold Spacer: 18-1908 with Riser 18-1971 or 18-1978 Elbows. Included in 18-1908K. Includes (1) 18-2849 & 18-0897 elbow gaskets.
	19	18-8514 MOUNTING KIT	N/A	Use with Elbows: 18-1971 & 18-1978. Includes 18-2833 gasket & 18-4008 block off plate.
	20	18-4362 MOUNTING KIT	N/A	Use with Elbows: 18-1971 & 18-1978. Includes 18-2833 elbow gasket.
	21	18-8548 HARDWARE KIT	N/A	Includes only hardware for 18-1950-1 & 18-1951-1 manifolds. Included in 18-8520 mounting kit.

# Fits Ford Small Block V8 302-351 cu. in. Models 215, 225, 233, 255 & 888

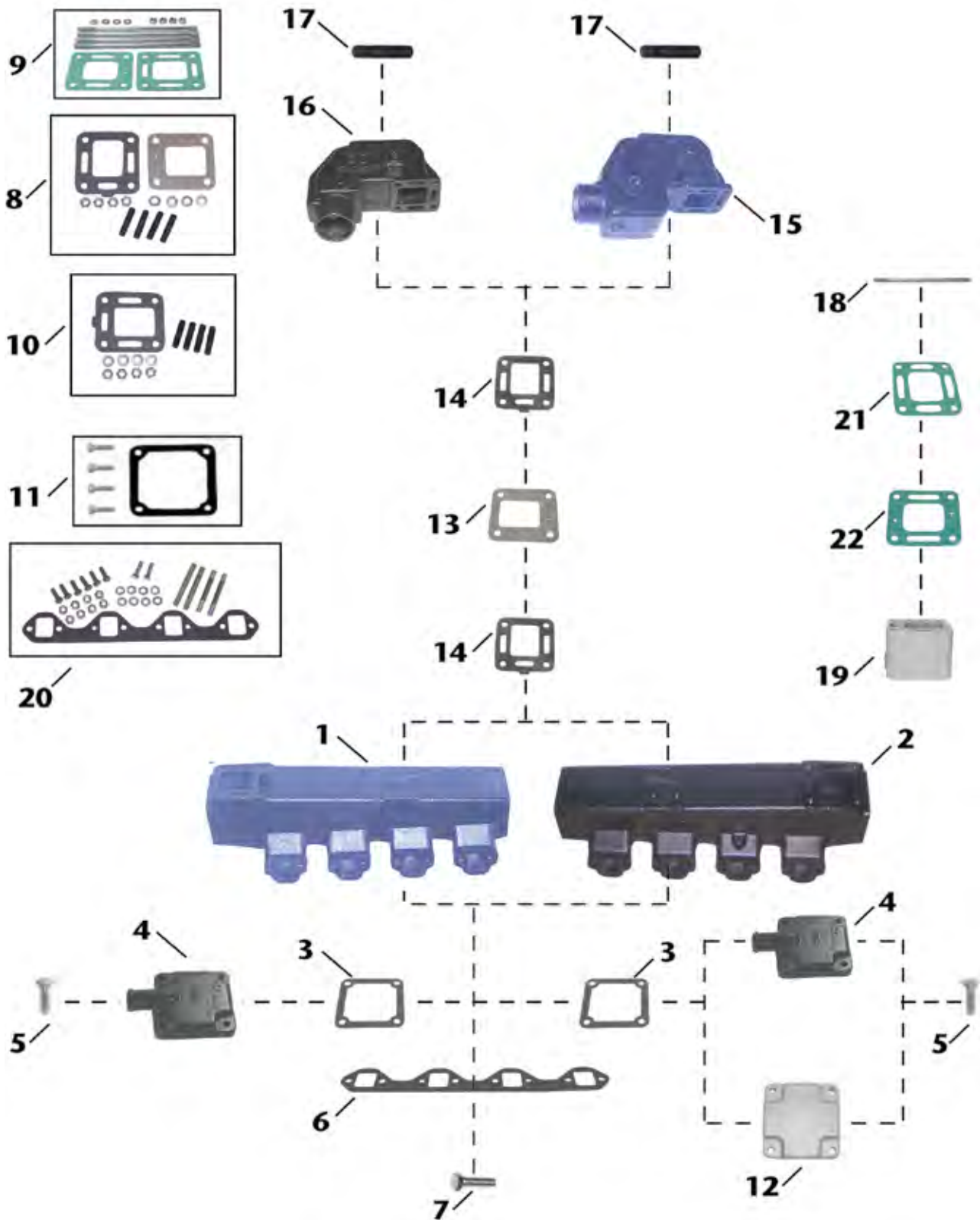

	Item No	Description	OE No.	Application
1	18-1958-1	MANIFOLD (PORT)	65604A4	Ford Small Block (V8) 302-351 cu.in. Models 215, 225, 233, 255, & 888 (Port). Use with Manifold Gasket: 18-0183; Mounting Kit: 18-8509.
2	18-1962-1	MANIFOLD (STARBOARD)	65603A4	Ford Small Block (V8) 302-351 cu.in. Models 215, 225, 233, 255, & 888 (Starboard). Use with Manifold Gasket: 18-0183; Mounting Kit: 18-8509.
3	18-2832	FRONT/END PLATE GASKET	27-48043-1	Fits Port & Starboard Caps of Manifolds: 18-1958-1, 18-1962-1. Use with Front Plate: 18-4009. Included in 18-8512 mounting kit.
4	18-4009	FRONT PLATE	60252A2	Use with (Port & Starboard) Manifolds: 18-1958-1, 18-1962-1; Mounting Kit: 18-8512
5	NSS	MOUNTING BOLT	N/A	Included in 18-8512 mounting kit.
6	18-0183	MANIFOLD GASKET	27-73866	Use with Manifold: 18-1958-1, 18-1962-1. Included in 18-8509 mounting kit.
7	NSS	MOUNTING BOLT	N/A	Included in 18-8509 mounting kit.
8	18-8514	MOUNTING KIT	N/A	Use with Elbows: 18-1971 & 18-1978. Includes 18-2833 gasket & 18-4008 block off plate.
9	18-8554	MOUNTING KIT	N/A	Use with Manifold Spacer: 18-1906 with Riser 18-1971 or 18-1978. Includes (1) 18-2849 & 18-0897 elbow gaskets.
10	18-4362	MOUNTING KIT	N/A	Use with Elbows: 18-1971 & 18-1978. Includes 18-2833 elbow gasket.
11	18-8512	MOUNTING KIT	N/A	Use with Front/End Plates: 18-4009. Includes 18-2832 gasket.
12	NSS	END PLATE	54870	Fits Manifolds: 18-1958-1, 18-1962-1; Mounting Kit: 18-8512.
13	18-4008	BLOCK OFF PLATE	60207	Use with Manifolds 18-1958-1, 18-1962-1. Requires (2) 18-2833 elbow gaskets
14	18-2833	ELBOW GASKET	27-99777-2	Use with Elbows: 18-1971 & 18-1978. Included in 18-4362 mounting kit.
15	18-1978	MANIFOLD ELBOW	76771A3	Use with Manifolds: 18-1958-1, 18-1962-1; Elbow Gasket 18-2833; Mounting Kit 18-4362.
16	18-1971	MANIFOLD ELBOW	76351A2	Use with Manifolds: 18-1958-1, 18-1962-1; Elbow Gasket 18-2833; Mounting Kit 18-4362.
17	18-3233	MOUNTING STUD	16-49545	3/8-24, 3/8-16 X 1 3/4. Included in 18-4362 mounting kit.
18	NSS	MOUNTING STUD	N/A	Included in 18-8554 mounting kit.
19	18-1906	MANIFOLD SPACER	61851	3" Spacer for Manifolds: 18-1950-1, 18-1951-1. Use with mounting kit 18-8554 with 18-1971 or 18-1978 Elbows.
20	18-8509	MOUNTING KIT	N/A	Use with Manifolds: 18-1958-1, 18-1962-1. Includes 18-0183 manifold gasket.
21	18-2849	ELBOW GASKET (OPEN)	27-818832	Fits Manifolds: 18-1958-1, 18-1962-1; Manifold Spacers: 18-1985. Included in 18-8554 mounting kit
22	18-0897	ELBOW GASKET (RESTRICTOR)	27-41813	Fits Manifolds: 18-1958-1, 18-1962-1; Manifold Spacers: 18-1985. Included in 18-8554 mounting kit

### Fits GM 4 Cylinder 181 cu. in. Models 120, 140, 2.5L & 3.0L

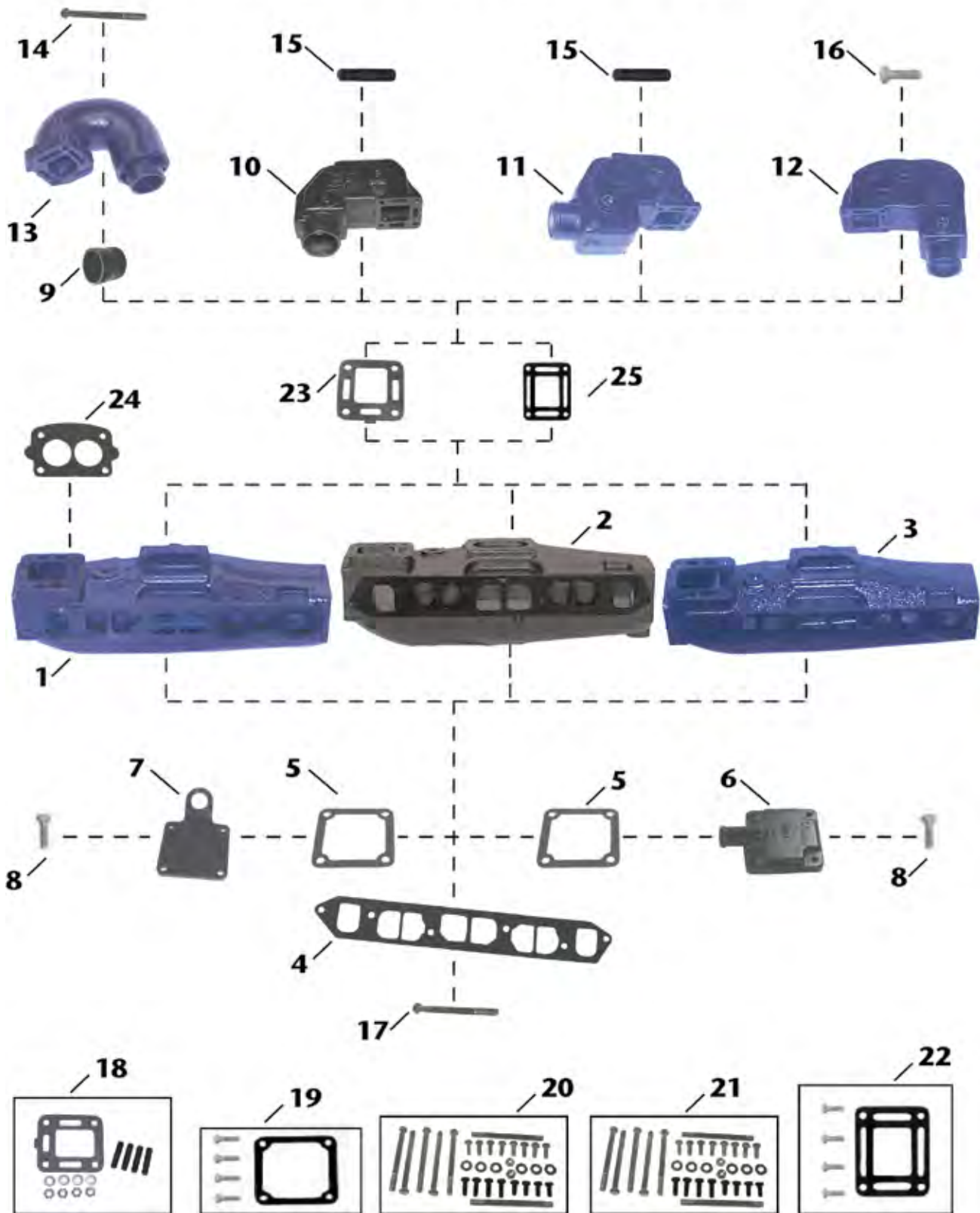



	<b>Item No</b>	<b>Description</b>	<b>OE No.</b>	<b>Application</b>
1	18-1954-1	MANIFOLD	9582A5	Fits 2.5 & 3.0L 181 CID, Model 140 with Rochester carburetor w/ electrical choke (1983-89). Use with Manifold Gasket: 18-1204.
2	18-1955-1	MANIFOLD	96705A1	Fits 3.0L 181 CID, Model 140 with Rochester carburetor w/ mechanical choke (1968-82). Use with Manifold Gasket: 18-1204. Mounting Hardware: 18-8549.
3	18-1956-1	MANIFOLD	99798A18	Fits 3.0L 181 CID, Model 140 & 3.0 with Mercarb carburetor w/ electrical choke (1983-95). Use with Manifold Gasket: 18-1204.
4	18-1204	MANIFOLD GASKET	27-96429	Fits Manifolds: 18-1954-1, 18-1955-1, 18-1956-1
5	18-2832	FRONT/ END CAP GASKET	27-48043-1	Fits Port & Starboard Caps of Manifolds: 18-1954-1, 18-1955-1, 18-1956-1.
6	18-4009	FRONT PLATE	60252A2	Fits Manifolds: 18-1954-1, 18-1955-1, 18-1956-1
7	18-5021	END PLATE	805629	Fits Manifolds: 18-1954-1, 18-1955-1, 18-1956-1
8	NSS	MOUNTING BOLT	N/A	Included in 18-8512 mounting kit.
9	18-2748	EXHAUST BOOT	32-44348T	4" Inside Diameter. Use with 18-1975-1 elbow.
10	18-1971	MANIFOLD ELBOW	76351A2	Use with Manifolds: 18-1954-1, 18-1955-1, 18-1956-1; Elbow Gasket 18-2833; Mounting Kit 18-4362
11	18-1978	MANIFOLD ELBOW	76771A3	Use with Manifolds: 18-1954-1, 18-1955-1, 18-1956-1; Elbow Gasket 18-2833; Mounting Kit 18-4362
12	18-1973	MANIFOLD ELBOW	55538A2	Use with Manifolds: 18-1954-1, 18-1955-1, 18-1956-1; Elbow Gasket 18-2833; Mounting Kit 18-8508
13	18-1975-1	MANIFOLD RISER	12076A2	Use with Manifolds: 18-1954-1, 18-1955-1, 18-1956-1; Elbow Gasket 18-2819; Mounting Hardware 18-8551; Exhaust Boot 18-2748.
14	NSS	MOUNTING BOLT	N/A	Included in 18-8551 mounting hardware.
15	18-3233	MOUNTING STUD	N/A	3/8-24, 3/8-16 X 1 3/4. Included in 18-4362 mounting kit.
16	NSS	MOUNTING BOLT	N/A	Included in 18-8508 mounting kit.
17	NSS	MOUNTING BOLT	N/A	Included in 18-8549 mounting kit.
18	18-4362	MOUNTING KIT	N/A	Use with Elbows: 18-1971 & 18-1978. Includes 18-2833 elbow gasket.
19	18-8512	MOUNTING KIT	N/A	Use with Front Plate: 18-4009 & End Plate (NSS). Includes 18-2832 front/end cap gasket.
20	18-8549	HARDWARE KIT	N/A	Includes only hardware for 18-1955-1 manifold.
21	18-8551	HARDWARE KIT	N/A	Includes only hardware for 18-1975-1 elbow.
22	18-8508	MOUNTING KIT	N/A	Use with Elbow 18-1973. Includes 18-2819 elbow gasket.
23	18-2833	ELBOW GASKET	27-99777-2	Use with Elbows: 18-1971 & 18-1978. Included in 18-4362 mounting kit.
24	18-0356	CARBURETOR GASKET	27-64692	Fits Manifolds: 18-1954-1, 18-1955-1, 18-1956-1
25	18-2819	ELBOW GASKET	27-39915	Use with Elbow: 18-1973. Included in 18-8508 mounting kit.

# Fits GM Small Block V8 305 & 350 cu. in. Models 200, 228, 230, 260 & 898

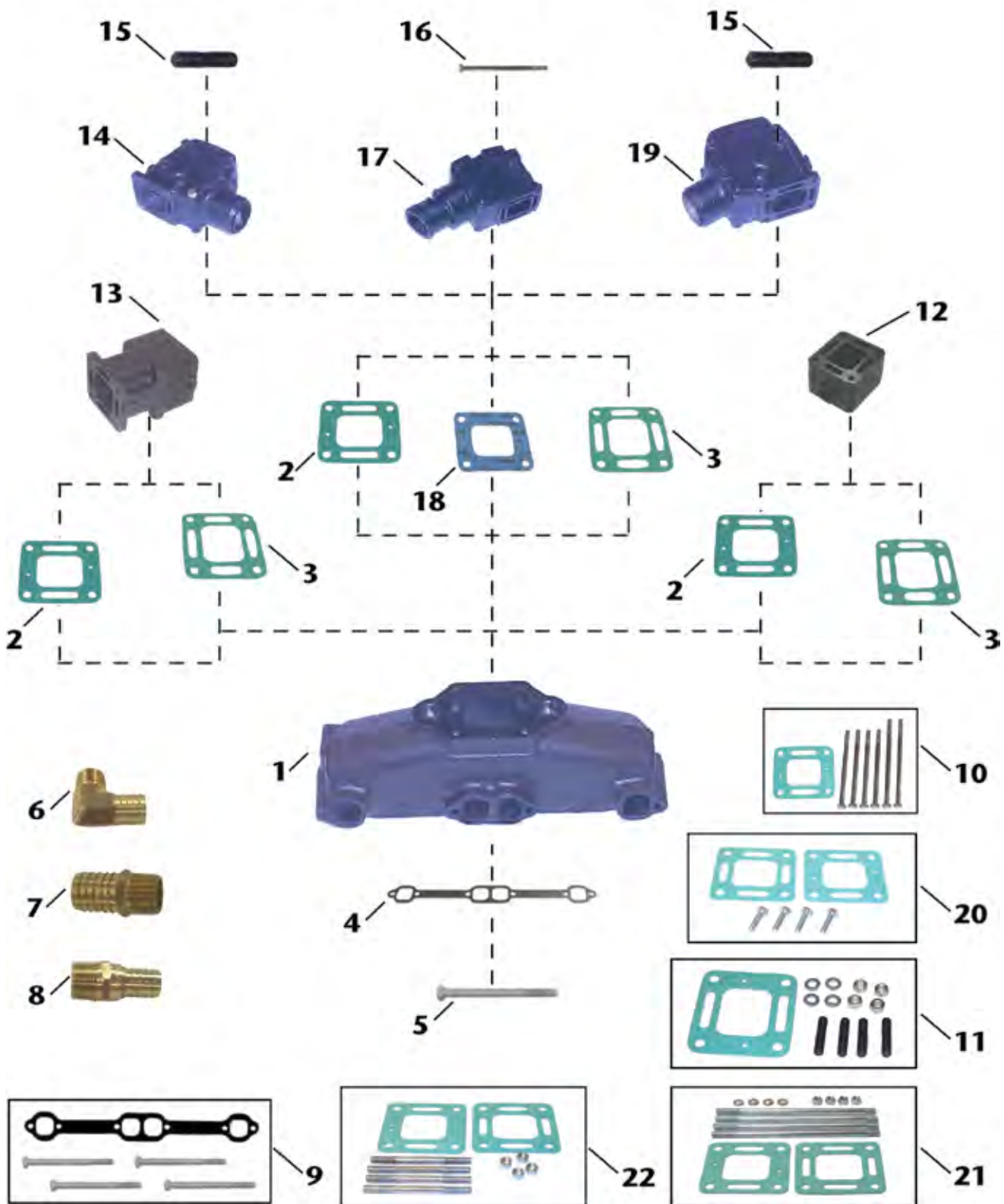

	Item No	Description	OE No.	Application
1	18-1953-2	MANIFOLD	87114A19	GM Small Block (V8) 305-350 cu.in. Models 200, 228, 230, 260, & 898
2	18-0897	ELBOW GASKET (RESTRICTOR)	27-41813	Fits Manifold: 18-1953-2; Manifold Spacers: 18-1985, & 18-1908; Elbows: 18-1970-1, 18-1976-1, 18-1974-1
3	18-2849	ELBOW GASKET (OPEN)	27-818832	Fits Manifold: 18-1953-2; Manifold Spacers: 18-1985, & 18-1908; Elbows: 18-1970-1, 18-1976-1, 18-1974-1
4	18-2949	MANIFOLD GASKET	96306	Use with Manifold: 18-1953-2. Included in 18-8520 mounting kit.
5	NSS	MOUNTING BOLT	N/A	Included in 18-8520 mounting kit.
6	18-8216	HOSE FITTING	N/A	3/4" - 14NPT X 1" Hose (Corrosion Resistant Brass Fitting)
7	18-4461	HOSE FITTING	N/A	3/4" - 14NPT X 1" Hose (Corrosion Resistant Brass Fitting)
8	18-8215	HOSE FITTING	N/A	3/4" - 14NPT X 3/4" Hose (Corrosion Resistant Brass Fitting)
9	18-8520	MOUNTING KIT	N/A	Use with Manifold: 18-1953-2. Includes 18-2949 manifold gasket.
10	18-8505	MOUNTING KIT	N/A	Use with Riser: 18-1976-1. Includes 18-0897 elbow gasket.
11	18-8529	MOUNTING KIT	N/A	Use with Risers: 18-1970-1, 18-1974-1. Includes 18-0897 elbow gaskets.
12	18-1908	MANIFOLD SPACER	933220A12	3" Spacer for Manifold: 18-1953-2. Use with mounting kit 18-8554 with 18-1970-1, or mounting kit 18-8555 with 18-1976-1.
13	18-1985	MANIFOLD SPACER	93322	6" Spacer for Manifold: 18-1953-2. Use with mounting kit 18-8556. (Note to mount elbows to spacer a separate mounting kit is required)
14	18-1974-1	MANIFOLD ELBOW	98502A2	Fits Manifold: 18-1953-2. Use Elbow gasket: 18-2849, 18-0897, or 18-0672; Use mounting kit: 18-8529. (Do not use with spacer)
15	NSS	MOUNTING STUD	N/A	Included in 18-8529 mounting kit.
16	NSS	MOUNTING BOLT	N/A	Included in 18-8505 mounting kit.
17	18-1976-1	MANIFOLD ELBOW	44354A3, 807914A1	Fits Manifold: 18-1953-2. Use Elbow gasket: 18-2849, 18-0897, or 18-0672; Use mounting kit: 18-8505, or if spacer is included use 18-8555.
18	18-0672	ELBOW GASKET (CLOSED)	27-860231	Fits Manifold: 18-1953-2; Manifold Spacers: 18-1985, & 18-1908; Elbows: 18-1970-1, 18-1976-1, 18-1974-1
19	18-1970-1	MANIFOLD ELBOW	98504A3	Fits Manifold: 18-1953-2. Use Elbow gasket: 18-2849, 18-0897, or 18-0672; Use mounting kit: 18-8529, or if spacer is included use 18-8554.
20	18-8556	MOUNTING KIT	N/A	Use with Manifold Spacer: 18-1985. Includes 18-0897 & 18-2849. (Note: To mount elbows to spacer a separate mounting kit is required.)
21	18-8555	MOUNTING KIT	N/A	Use with Riser Kit 18-1908K: Spacer 18-1908: Riser 18-1976-1: Manifold: 18-1952-1
22	18-8554	MOUNTING KIT	N/A	Use with Riser Kit 18-1908K: Spacer 18-1908: Riser 18-1970-1: Manifold: 18-1952-1

## SIERRA MANIFOLDS ARE PAINTED, PACKAGED AND LEAK TESTED

**18-1998-1  
MANIFOLD**

Port & Starboard  
Replaces: Barr FM-1-83  
Universal Center Riser Manifold

FITS: Ford 302 and 351 CID engines  
Comes with 18-4363 Mounting Package

Use with:  
Exhaust Manifold Gasket Set: 18-0603  
**\*For Exploded View - See Pages 560-561**



**18-1997-1  
MANIFOLD**

Port & Starboard  
Replaces: Barr CHV-1-83 Universal Center Riser Manifold  
FITS: GM 283, 305, 307 and 350 CID engines

Use with:  
Exhaust Manifold Gasket Set: 18-0604  
**\*For Exploded View - See Pages 558-559**



**18-1898  
MANIFOLD**

Port & Starboard  
Replaces: Barr CHVA-1-84, Marine Power  
0991-110

Fits 454 cu. in. GM big block V8 engines

Use with:  
Exhaust Manifold Gasket: 18-0418  
Riser: 18-1939, 18-1999  
**\*For Exploded View - See Pages 556-557**



**18-1951-1\*  
MANIFOLD**

Supplied with Mounting Package  
Replaces: 77235A2, 77235A8  
STARBOARD SIDE

Fits most Mercruiser (GM) small blocks with end riser

Use with:  
Exhaust Manifold Gasket: 18-2949  
Mounting Kit: 18-8548

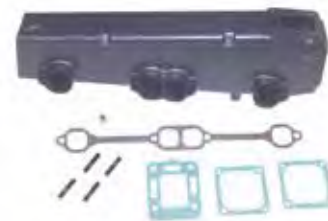

**18-1950-1\*  
MANIFOLD**

Supplied with Mounting Package  
Replaces: 77234A2  
PORT SIDE  
Fits most Mercruiser (GM) small blocks with end riser

Use with:  
Exhaust Manifold Gasket: 18-2949  
Mounting Kit: 18-8548



**18-1952-1\*  
MANIFOLD**

Port & Starboard  
Replaces: 99746A8, A17  
Fits most 4.3L (262 CID) V-6 application

Supplied with Mounting Package  
Use with:  
Mounting Kit: 18-8533



**18-1953-2  
MANIFOLD**

Port & Starboard  
Supplied with Mounting Package  
Replaces: 87114A19,86024A10

Will fit either side - Fits most Mercruiser(GM) small blocks with center riser.

Supplied with gaskets  
Use with:  
Mounting Kit: 18-8520



**18-1954-1\*  
MANIFOLD**

Supplied with Mounting Package  
Replaces: 95862A5  
Fits most late Model 2.5L 153 CID & 3.0L 181 CID with Rochester Carb  
5 BOLT PATTERN (1983-89)

Use with:  
Exhaust Manifold Gasket: 18-1204  
End Plate: 18-4009





**18-1958-1-1\***  
**MANIFOLD**  
 Replaces: 65604A4, A12 PORT SIDE ONLY  
 Fits most Mercruiser (Ford) V-8 small blocks  
 Supplied with Mounting Package  
 Use with:  
 Mounting Kit: 18-8509



**18-1955-1\***  
**MANIFOLD**  
**New Style**  
 Supplied with Mounting Package  
 Replaces: 96705A1  
 Fits most early Model 3.0L 181 CID with Rochester Carb. 5 bolt pattern and 2.5L, 153CID (1968-82)  
 Use with:  
 Exhaust Manifold Gasket: 18-1203  
 End Plate: 18-4009



**18-1956-1\***  
**MANIFOLD**  
 Supplied with Mounting Package  
 Replaces: 99798A18, 806867A8  
 Fits most late Model 2.5L 153 CID and 3.0L 181 CID with MerCarb 5 bolt pattern with electric choke (1983-95)  
 Use with:  
 Exhaust Manifold Gasket: 18-1204  
 End Plate: 18-4009



**18-1957-1\***  
**MANIFOLD**  
 Port & Starboard  
 Replaces: 89011A8, 807078A6  
 WILL FIT EITHER SIDE  
 Fits most Mercruiser (GM) V-8 big blocks with center riser  
 Use with:  
 Exhaust Manifold Gasket: 18-0418  
 Mounting Kit: 18-8532



**18-1987-1**  
**MANIFOLD**  
**CONVERSION KIT**  
 Not for use on engines with high mounted power steering pumps

**KIT INCLUDES:**  
 2 Center rise manifolds  
 2 Exhaust elbows  
 1 Thermostat housing  
 1 Thermostat cover  
 1 Thermostat  
 All hoses, hardware, gaskets plus complete instructions to do the job right!

**This Manifold Kit is designed to convert all Mercruiser Stern Drive Engines with GM 305 & 350 CID Blocks that have Log Style Exhaust Manifolds and Raw Water Cooling to the Newer More Efficient Center Rise Manifolds**



**18-1960-1\***  
**MANIFOLD**  
 Replaces: 58759A10, A14  
 Fits most Mercruiser (GM) Inline 6 Cyl. Engines  
 Supplied with Mounting Package  
 Use with:  
 Mounting Kit: 18-8531



**18-1962-1-1\***  
**MANIFOLD**  
 Starboard  
 Replaces: 65603A4, 65603A12  
 Fits most Mercruiser Engines (Ford) V-8 Small blocks  
 Supplied with Mounting Package  
 Use with:  
 Mounting Kit: 18-8509



**18-1999  
ELBOW**  
Replaces: Barr 20-0082  
Comes with 18-4364 open Mounting Package -  
Use with:  
Manifold: 18-1997-1 or 18-1998-1  
or 18-1898  
Riser Gasket: 18-2854 open or  
18-0476 blocked  
Mounting Kit: 18-4364 open or  
18-8535 blocked



**18-1970-1\*  
ELBOW**  
Replaces: 98504A3  
Fits V-6 & V-8 applications, 15° (3" O.D. Riser) Comes  
with 18-0897 & brass plugs  
Use with:  
Manifold: 18-1952-1, 18-1953-2, 18-1957-1  
Elbow Gasket: 18-0897 restrictor, 18-2849  
open, 18-0672 blocked  
Mounting Kit: 18-8529



**18-1971\*  
ELBOW**  
Replaces: 76351A2  
Fits most early model Mercruiser 140 HP (4 cyl)  
applications  
Replaces: Barr MC20-60426P  
Use with:  
Manifold: 18-1960-1, 18-1958-1, 18-1950-1  
Elbow Gasket: 18-2833  
Mounting Kit: 18-4362



**18-1992-1  
EXHAUST ADAPTER**  
For 3" I.D. Exhaust Hose  
(As used in 18-1987 Exhaust Manifold Conversion Kit)  
80°



**18-1972\*  
ELBOW**  
Replaces: 76325A2  
Fits most late Model 120, 140 HP Mercruiser applications  
Use with:  
Manifold: 18-1955-1, 18-1954-1,  
18-1956-1, 18-1901  
Elbow Gasket: 18-2833  
Mounting Kit: 18-8552



**18-1973\*  
ELBOW**  
Replaces: 55538A2  
Fits most early Model 120 HP Mercruiser applications



**18-1991  
ELBOW ADAPTER**  
For use with 3" I.D. Exhaust Hose  
Use with:  
Manifold Riser: 18-1999  
30°



**18-1978  
ELBOW**  
Replaces: 76771A3, A2  
V-8 Inboard Applications Only  
Use with:  
Manifold: 18-1950-1, 18-1951-1,  
18-1958-1, 18-1962-1  
Elbow Gasket: 18-2833  
Mounting Kit: 18-4362



**18-1905  
ELBOW**  
Replaces: 90880  
Mercruiser 4 Cylinder 224cu. in. 3.7L  
(Models: 165, 170, 180, 190).  
Use with:  
Manifold: Mercruiser 99908  
Exhaust Elbow Mounting Gasket: 18-0113  
Mounting Kit: 18-8500



**18-1937  
ELBOW**  
Replaces: 98562A6  
Mercruiser 4 Cylinder 224cu. in. 3.7L (Models: 165, 170, 180, 190).  
Use with:  
Exhaust Elbow Mounting Gasket: 18-0881  
Mounting Kit: 18-8530



**18-1974-1\*  
ELBOW**  
Replaces: 98502A2  
Fits V-6 & V-8 applications 0° (3" O.D. Riser)  
Comes with 18-0897 gasket & brass plugs

\* SEE APPLICATION CHART ON PAGE 671-675 FOR SPECIFIC MODELS



**18-1975-1-1\*  
RISER**

Replaces: 12076A2  
Fits late Model Mercruiser 4 cyl. Engines  
Use with:  
Manifold: 18-1955-1, 18-1954-1, 18-1956-1, 18-1901  
Riser Gasket: 18-2833  
Mounting Kit: 18-8551  
Bellow: 18-2748



**18-1976-1\*  
ELBOW**

Replaces: 44354A3, 807914A1  
Fits most Mercruiser V-6 & V-8 applications 7" (4" O.D. Riser) Comes with 18-0897, 18-4263 & 18-4258  
Use with:  
Manifold: 18-1952-1, 18-1953-2, 18-1957-1  
Riser Gasket: 18-0897 restrictor, 18-2849 open, 18-0672 blocked  
Mounting Kit: 18-8505



**18-1939  
RISER**

Replaces: Barr 20-0100, Marine Power 0992-593 Barr, Indmar and Marine Power Ford Small Block V8 302-351cu. in. GM Small Block V8 305-350cu. in., GM Big Block V8 454cu in.  
Use with:  
Manifold: 18-1997-1, 18-1998-1, 18-1898  
Riser Gasket: 18-2854 open or 18-0476 blocked  
Mounting Kit: 18-4364 open or 18-8535 blocked



**18-1907  
RISER**

Replaces: Barr 20-0102, Indmar 53-2009 and 53-2018 Barr, Indmar Ford Small Block V8 302-351cu. in.  
Use with:  
Manifold: 18-1997-1, 18-1998-1  
Riser Gasket: 18-2854 open or 18-0476 blocked  
Mounting Kit: 18-4364 open or 18-8535 blocked



**18-1908K  
MANIFOLD RISER SPACER KIT**

Replaces: 807476A6, 93320A5  
Alpha/Bravo/Gen+/GenIV GM Small Block V-8 305, 350, 4.3L, 454, 5.0, 5.7L, 502, 7.4L, 8.2L, (3" Riser Kit)  
Complete with Mounting Hardware. Center Rise 3" PACKAGED AS SET  
Use with:  
Manifold: 18-1952-1  
3"



**18-1906  
MANIFOLD SPACER**

Replaces: 61851A1  
3" Spacer for 18-1950, 18-1951, 18-1958-1 & 18-1962-1 manifolds



**18-1908  
MANIFOLD RISER SPACER - 3"**

Mercruiser GM V6 229 and 262cu.in. (Models: 185 and 205), GM Small Block V8 305-350cu.in. (Models: 200, 228, 230, 260 and 898), GM Big Block V8 454cu.in. (Models: 330, 340 and 7.4L)  
Used with:  
Manifolds: 18-1952-1, 18-1953-2, 18-1957-1



**18-1985  
MANIFOLD SPACER - 6"**

Replaces: 93322  
For: 229 and 262 V6, 305-350 Small Block V8, 454 Big Block V8  
Used with:  
Manifold: 18-1952-1, 18-1957-1, 18-1953-2



**18-1949  
MANIFOLD SPACER**

Barr, Indmar and Marine Power Ford Small Block V8 302-351cu.in., GM Small Block V8 305-350cu.in., GM Big Block V8 454cu.in.  
Used with:  
Manifold: 18-1998-1, 18-1997-1 and 18-1898



**18-1990  
MANIFOLD BLOCK OFF PLATE**

Replaces: 73813A1



**18-5021  
END PLATE**  
Replaces: Mercuriser 805629  
Use with:  
Manifold: 18-1954-1,  
18-1955-1, 18-1956-1



**18-1995  
MANIFOLD END PLATE**  
Replaces: 47638  
GM 4 cyl. 153 cu. in. For model  
110/120 where carb. linkage  
mounts to the rear of the engine



**18-4008  
BLOCK-OFF PLATE**  
Replaces: 60207  
Use with:  
Riser: 18-1971, 18-1978



**18-4009  
MANIFOLD END PLATE**  
Replaces: 60252A2  
Use with:  
Manifold: 18-1960-1, 18-1958-1,  
18-1950-1, 18-1951-1  
End Plate Gasket: 18-2832  
Mounting Kit: 18-8512



**PIPE PLUGS**

Part #	Replaces	Thread Size	Description
18-4257	—	1/4"	Blacksteel Plug
18-4263	22-32802, 22-328022	1/8" - 27 NPT	Pipe Plug
18-4264	22-32803	3/8" - 18 NPT	Pipe Plug
18-4265	22-428611	3/4" - 14 NPT	Pipe Plug
18-8111①	22-36392	1/4 - 18 NPT	Pipe Plug
18-4258	22-33198A1 22-41622	3/4 - 14 NPT	Pipe Plug

56507 Pipe Sealant with Teflon® is recommended for use on plug threads.



**RISER BOLTS**

Part #	Replaces	Thread Size	Description
18-8410	10-43749	3/8"-16 x 5 3/4"	Use Without Remote Oil Filter
18-8411	10-44387	3/8"-16 x 6 3/4"	Use With Remote Oil Filter



**18-4362  
EXHAUST ELBOW MOUNTING KIT**  
Replaces: Barr MC20-60426P  
Use with:  
Elbow: 18-1971



**18-4363  
EXHAUST ELBOW MOUNTING KIT**  
Replaces: Barr FM-1-83-P  
Use with:  
Manifold: 18-1998-1



**18-4364 (Open)  
EXHAUST ELBOW MOUNTING KIT**  
Replaces:  
Barr 20-0082-P  
Use with:  
Riser: 18-1999, 18-1907, 18-1939



**18-8500  
EXHAUST ELBOW MOUNTING KIT**  
Mercuriser 4 Cylinder 224cu.in. 3.7L  
(Models: 165, 170, 180, 190)  
Used with:  
Elbow/Reservoir: 18-1905



**18-8505  
EXHAUST ELBOW MOUNTING KIT**  
Mercuriser GM V6 229 and 262cu.in.  
(Models 185 and 205), GM Small Block  
V8 305-350cu.in. (Models: 200, 228, 230,  
260, 898), GM Big Block V8 454cu.in.  
(Models: 330, 340 and 7.4L)  
Used with:  
Riser: 18-1976-1



**18-8508  
EXHAUST MANIFOLD MOUNTING KIT**  
Mercuriser GM 4 Cylinder 153cu.in.  
(Early models 110/120), GM Inline  
Cylinder 250cu.in.(Model: 160)  
Used with:  
Riser: 18-1973

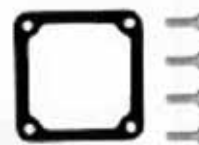

**18-8512  
EXHAUST ELBOW  
MOUNTING KIT**  
Mercuriser GM 4 Cylinder 181cu.in. (Models:  
120,140, 2.5L,3.0L), GM Inline 6 Cylinder  
250-292cu.in. (Models: 165 and 200), Ford  
Small Block V8 302-351cu.in. (Models:  
215,225,233, 255,888), GM Small Block V8  
305, 350cu.in.(Models: 198,228,898)  
Used with:  
Front Plate: 18-4009

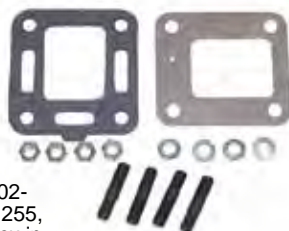

**18-8514  
EXHAUST ELBOW  
MOUNTING KIT**  
Mercuriser Ford Small Block V8 302-  
351cu.in. (Models: 215, 225, 233, 255,  
888), GM Small Block V8 305-351cu.in.  
(Models: 198,228,898)  
Used with:  
Riser: 18-1971 & 18-1978  
(Not for Fresh Water/Closed Cooling  
Systems)

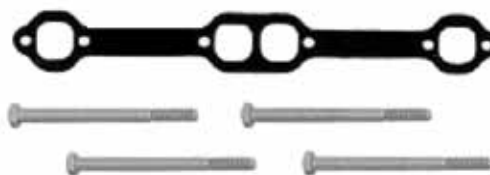

**18-8520  
EXHAUST MANIFOLD MOUNTING KIT**  
Mercuriser GM Small Block V8 305-350cu.  
in. (Models: 198, 200, 228, 230, 260, 898)  
Used with:  
Manifold: 18-1950-1,18-1951-1, 18-1953-2

① This product is priced per piece. To order priced per package, please add -9 to the part number





**18-8529  
EXHAUST ELBOW  
MOUNTING KIT**  
Mer cruiser GM V6 229 and 262cu.in.  
(Models 185 and 205), GM Small  
Block V8 305-350cu.in. (Models: 200,  
228, 230, 260, 898), GM Big Block V8  
454cu.in. (Models: 330, 340 and 7.4L)  
Used with:  
Riser: 18-1970-1



**18-8530  
EXHAUST ELBOW MOUNTING KIT**  
Mer cruiser 4 Cylinder 224cu.in. 3.7L  
(Models: 165, 170, 180, 190)  
Used with:  
Elbow/Reservoir: 18-1937



**18-8531  
EXHAUST MANIFOLD MOUNTING KIT**  
Mer cruiser GM Inline 6 Cylinder 250cu.in.  
(Models: 165 and 200)  
Used with :  
Manifold: 18-1960-1



**18-8532  
EXHAUST MANIFOLD MOUNTING KIT**  
Mer cruiser GM Big Block V8 454cu.in.  
(Models: 330, 340 and 7.4L)  
Used with:  
Manifold: 18-1957-1



**18-8533  
EXHAUST MANIFOLD MOUNTING KIT**  
Mer cruiser GM V6 229 and 262cu.in.  
(Models 185 and 205)  
Used with:  
Manifold: 18-1952-1



**18-8535 (Blocked)  
EXHAUST ELBOW  
MOUNTING KIT**  
Barr, Indmar and Marine Power  
Ford Small Block V8 302-351cu.in., GM  
Small Block V8 305-350cu.in., GM Big Block  
V8 454cu.in.  
Used with:  
Risers: 18-1939, 18-1999, and 18-1907



**18-8536  
EXHAUST ELBOW MOUNTING KIT**  
Barr, Indmar and Marine Power GM  
Small Block V8 305-350cu.in.  
Used with:  
Manifold: 18-1997-1



**18-8538  
EXHAUST MANIFOLD MOUNTING KIT**  
Barr and Indmar Ford Small Block V8  
302-351cu.in.  
Used with:  
Manifold: 18-1998-1



**18-8554  
EXHAUST ELBOW MOUNTING KIT**  
For: 229 and 262 ci V6, 305 and 350  
SB V8, 454 Big Block V8.  
Used with:  
Riser Kit: 18-1908K and 18-1908 Spacer  
Riser: 18-1970-1  
Manifold: 18-1952-1



**18-8555  
EXHAUST ELBOW MOUNTING KIT**  
For: 229 and 262 ci V6, 305 and  
350 SB V8, 454 Big Block V8.  
Used with:  
Riser Kit: 18-1908K and 18-1908 Spacer  
Riser: 18-1976-1  
Manifolds: 18-1952-1



**18-8556  
EXHAUST ELBOW MOUNTING KIT**  
For: 229 and 262 ci V6, 305 and 350  
SB V8, 454 Big Block V8. Used to mount  
Spacer 18-1985 to 18-1953-2,  
18-1957-1 and 18-1952-1 Manifolds



**HARDWARE KITS**

Part #	Fits
18-8548	18-1950-1 & 18-1951-1 Manifold
18-8549	18-1955-1 Manifold
18-8551	18-1975-1 Exhaust Elbow









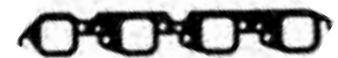









**18-0183  
EXHAUST MANIFOLD GASKET**  
Replaces: Mercruiser 27-73866  
Volvo 3853742, 3852455, OMC 908717  
Used with:  
Manifold: 18-1962-1, 18-1938, 18-1998-1,  
18-1996, 18-1979

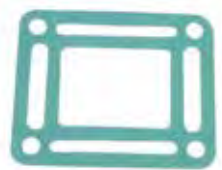

**18-0353  
CARB MOUNTING GASKET**  
Replaces: 27-58764  
Used with:  
Manifold: 18-1960-1

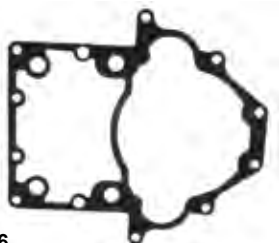

**18-0418  
EXHAUST MANIFOLD GASKET**  
Replaces: 27-46820  
Use with :  
Manifolds: 18-1957-1, 18-1982,  
18-1929, 18-1933, 18-1898

 <p><b>18-0476</b> <b>RISER BLOCK OFF GASKET</b> Barr, Indmar &amp; Marine Power Ford Small Block V8 302-351cu.in. Used with: Risers: 18-1939, 18-1999, 18-1907</p>	<p>PKG OF 2</p>  <p><b>18-0672</b> <b>18-0672-9①</b> <b>EXHAUST ELBOW GASKET</b> Replaces: 27-860231,8637251 Used with: Riser: 18-1970-1, 18-1976-1</p>	 <p><b>18-0872</b> <b>EXHAUST MANIFOLD GASKET</b> Replaces: Mercuriser 27-33395 GM 5.0L &amp; 5.7L Use with: Manifold: 18-1950-1, 18-1951-1</p>	 <p><b>18-0881</b> <b>EXHAUST ELBOW GASKET</b> Replaces: 27-18272 Included in 18-8530 mounting kit Used with: Elbow: 18-1937</p>
<p>PKG. OF 2</p>  <p><b>18-0885</b> <b>18-0885-9①</b> <b>EXHAUST ELBOW GASKET</b> Replaces: 27-48042</p>	<p>PKG. OF 2</p>  <p><b>18-0897 (Restrictor)</b> <b>EXHAUST ELBOW GASKET</b> Replaces: 27-41813 Used with: Riser: 18-1976-1, 18-1970-1</p>	<p>PKG. OF 2</p>  <p><b>18-1204</b> <b>18-1204-9①</b> <b>EXHAUST MANIFOLD GASKET</b> Replaces: 27-96429</p>	<p>PKG. OF 2</p>  <p><b>18-1210</b> <b>18-1210-9①</b> <b>END CAP GASKET</b> Replaces: 27-39923</p>
<p>PKG OF 2</p>  <p><b>18-2819</b> <b>18-2819-9①</b> <b>EXHAUST ELBOW GASKET</b> Replaces: 27-39915</p>	<p>PKG OF 2</p>  <p><b>18-2830</b> <b>EXHAUST MANIFOLD GASKET</b> <b>6 cyl.</b> Replaces: 27-46401</p>	<p>PKG OF 2</p>  <p><b>18-2832</b> <b>18-2832-9①</b> <b>MANIFOLD END CAP GASKET</b> Replaces: 27-480431 Use with: Manifolds: 18-1951-1, 18-1950-1, 18-1954-1, 18-1958-1, 18-1955-1, 18-1956-1, 18-1960-1, 18-1962-1 End Plate: 18-4009</p>	
<p>PKG OF 2</p>  <p><b>18-2833</b> <b>18-2833-9①</b> <b>EXHAUST ELBOW GASKET</b> Replaces: 27-997772</p>	<p>PKG OF 2</p>  <p><b>18-2849 (Open)</b> <b>18-2849-9①</b> <b>EXHAUST ELBOW GASKET</b> Replaces: 27-87105-1, 27-818832, 27-863726 Use with: Elbow: 18-1976-1, 18-1970-1</p>	<p>PKG. OF 2</p>  <p><b>18-2854 (Open)</b> <b>18-2854-9①</b> <b>EXHAUST ELBOW GASKET</b> Replaces: Barr 01-0107 Use with : Riser: 18-1999, 18-1939, 18-1907</p>	
 <p><b>18-2896</b> <b>EXHAUST MANIFOLD GASKET</b> Replaces: 27-52546 GM 4 cyl. 153 cu. in. For model 110/120 where carb. linkage mounts to the rear of the engine</p>	<p>PKG. OF 2</p>  <p><b>18-2909</b> <b>18-2909-9①</b> <b>EXHAUST MANIFOLD GASKET</b> For: GM V-6 Used with: Manifold: 18-1952-1</p>	 <p><b>18-2912</b> <b>EXHAUST MANIFOLD GASKET</b> Replaces: 27-53354</p>	

① Priced per Package

PKG. OF 2



**18-2949**  
**18-2949-9②**  
**EXHAUST MANIFOLD GASKET**  
Replaces: Barr CHV-47-000  
Use with:  
Manifold: 18-1997-1



**18-0603**  
**EXHAUST MANIFOLD GASKET SET**  
For: Ford 302/351 CID Engines  
For use with **18-1998-1**



**18-0604**  
**EXHAUST MANIFOLD GASKET SET**  
For: GM 305/350 CID Engines  
For use with **18-1997-1**



①**18-4218D** Display Package

**18-4218**  
**DRAIN TAP**  
Replaces: 22-87238, 22-16951A1,  
22-16951T1, Q1 1/4" NPT  
**18-3223-9②**  
Bulk pack of 12



①**18-4224D** Display Package

**18-4224**  
**DRAIN ELBOW ASSEMBLY**  
Replaces: 22-806926A1



**18-4226**  
**DRAIN PLUG**  
Replaces: 22-806608A1



**18-4227**  
**DRAIN ELBOW**  
Replaces: 22-806926



**18-4461**  
**HOSE BARB**  
Replaces: 22-807155  
3/4" - 14 NPT x 1" Hose  
Corrosion Resistant Brass Fitting



**18-8216**  
**HOSE BARB**  
Replaces: 22-36305  
Fits: Mercruiser- V6 (229 and 262ci), Small Block V8 (305-350ci), Big Block V8 (454ci)

① Items ending in "D" are Display Packaged - Regular number is Non-Display  
② Priced per Package

**MANIFOLD/MANIFOLD GASKET APPLICATION**

Liter	Model	Note	CID	# Cyl	Stroke	Year Range	Serial Number Range	Exh Manifold Port	Exh Manifold Starboard	Exh Elbow	End Cap Front	End Cap Rear	Manifold Gasket	Exh Elbow Gasket
2.5L	120		153	4	4	1966-1982	2046625 - 6229717						27-52546	18-2819
2.5L	120		153	4	4		2324347 - 3377340					18-1995	18-2896	18-2819
2.5L	120		153	4	4		3377341 - 5192408					18-1995	18-2896	18-2819
2.5L	120		153	4	4		5192049 - 6229717					18-1995	18-2896	18-2819
2.5	120		153	4	4	1983-1986	6229718 - B5311853				18-4009		18-1204	18-2833
2.5L	2.5L		153	4	4	1987-1989	B531854 - C853255	18-1956-1			18-4009	18-4009	18-1204	18-2833
3.0L	140		181	4	4	1968-1982	2508261 - 6229717	18-1955-1		18-1971	18-4009	18-1990	18-2912	18-2833
3.0L	140		181	4	4		3332138 - 5157668	18-1955-1				18-4009	18-1203	18-2833
3.0L	140		181	4	4		5157669 - 6229717	18-1955-1				18-4009	18-1203	18-2833
3.0L	140		181	4	4	1983-1986	6229718 - B450800			18-1975-1	18-4009		18-1204	18-2833
3.0L	3.0L		181	4	4	1990-1994	C856559 & UP	18-1956-1		18-1975-1	18-4009		18-1204	18-2833
3.0L	3.0L		181	4	4	1987-1989	B450801 - C856558			18-1975-1	18-4009		18-1204	18-2833
3.0L	3.0L		181	4	4	1998-2003	L010042 - M679999	18-1956-1		18-1975-1	18-1990		18-1204	18-2833
3.0L	3.0L		181	4	4	2003-2010	M680000 & UP	18-1956-1		18-1975-1			18-0680	18-2833
3.0L	3.0LX		181	4	4	1990-1997	C856559 - K999999	18-1956-1		18-1975-1	18-1990		18-0680	18-2833
3.0L	3.0L MPI / 3.0L EC		181	4	4	2008-2010	A072812 & UP						18-0680	
	150			4	4		1666495 - 2048046						18-2830	
	160			4	4		2048022 - 2770031						18-2830	
3.7L	165		224	4	4	1987	B434941 - B774251		Ⓢ	18-1937			18-0956	18-0881
3.7L	165		224	4	4	1987	B434941 - B774251		Ⓢ				18-0956	
3.7L	165		224	4	4		2770032 & up	18-1960-1				18-4009	18-2830	18-2833
3.7L	170		224	4	4	1985-1986	6916779 - B434940		Ⓢ	18-1937			18-0956	18-0881
3.7L	170		224	4	4	1985-1986	6916779 - B434940		Ⓢ				18-0956	18-0113
3.7L	180		224	4	4	1987	B436391 - B775248		Ⓢ	18-1937			18-0956	18-0881
3.7L	180		224	4	4	1987	B436391 - B775248		Ⓢ				18-0956	18-0113
3.7L	190		224	4	4	1985-1986	6916779 - B436390		Ⓢ	18-1937			18-0956	18-0881
3.7L	190		224	4	4	1985-1986	6916779 - B436390		Ⓢ				18-0956	18-0113
3.7L	3.7L		224	4	4	1988-1989	B774252 & UP		Ⓢ	18-1937			18-0956	18-0881
3.7L	3.7L		224	4	4	1988-1989	B774252 & UP		Ⓢ				18-0956	
3.7L	3.7LX		224	4	4	1988-1989	B775249 & UP		Ⓢ	18-1937			18-0956	18-0881
3.7L	3.7LX		224	4	4	1988-1989	B775249 & UP		Ⓢ				18-0956	18-0113
	470		224	4	4	1976-1977	4208730 - 4625579						18-0956	18-2833
	470 MCM / 470 MIE		224	4	4	1977-1982	4625580 - 6218036						18-0956	18-2833
	470		224	4	4	1983-1984	6218037 - 6916778						18-0956	18-0113
	485		224	4	4	1980-1982	5685394 - 6218036						18-0956	
	488		224	4	4	1983-1984	6170297 - 6916778						18-0956	18-0113
	140		194	6	4	1963	1538930 - 1725960						18-2830	
	150		230	6	4	1964-1966	1666495 - 2048046						18-2830	
	160		250	6	4	1967-1969	2048022 - 2770031						18-2830	
	165		250	6	4	1970-1981	2770032 - 5813433	18-1960-1		18-1971	18-4009	18-1990	18-2830	18-2833
	200		292	6	4	1969	2453769 - 2712072	18-1960-1		18-1971		18-1990	18-2830	18-2833
	185	4bb1	229	6	4	1983-1984	6330183 - 6919655	18-1952-1		18-1970-1			18-2909	18-0897
	175		262	6	4	1987	B527955 - B773242	18-1952-1		18-1952-1			18-2909	18-0897

- Ⓢ For engines with aluminum exhaust manifolds
- Ⓢ For engines with cast iron exhaust manifolds
- Ⓢ 3" (76mm) O.D. & 0 degree down angle
- Ⓢ 3" (76mm) O.D. & 15 degree down angle
- Ⓢ 4" (102mm) O.D.
- Ⓢ 2 piece exhaust manifold
- Ⓢ 1 piece exhaust manifold
- Ⓢ Has a rectangular elbow mounting bolt pattern
- Ⓢ Has a square elbow mounting bolt pattern
- Ⓢ In-line applications
- Ⓢ V-drive applications
- Ⓢ Standard rise
- Ⓢ 2" (51mm) rise
- Ⓢ 3" (76mm) rise
- Ⓢ 6" (152mm) rise
- Ⓢ Port
- Ⓢ Starboard
- Ⓢ Engines with risers or closed cooling may require a different gasket than listed
- Ⓢ Exhaust manifold with external water rail
- Ⓢ Exhaust manifold w/o external water rail
- Ⓢ 1 piece exhaust manifold is n/a. Engine must be converted to the 2 piece exhaust system
- Ⓢ Engines with easy drain system
- Ⓢ Engines with multi-point drain system
- Ⓢ Intermediate collector housing

MANIFOLD/MANIFOLD GASKET APPLICATION (Cont.)

Table with columns: Liter, Model, Note, CID, # Cyl, Stroke, Year Range, Serial Number Range, Exh Manifold Port, Exh Manifold Starboard, Exh Elbow, End Cap Front, End Cap Rear, Manifold Gasket, Exh Elbow Gasket. Rows list various engine models and their corresponding gasket applications.

- Ⓚ For engines with aluminum exhaust manifolds
Ⓚ For engines with cast iron exhaust manifolds
Ⓚ 3" (76mm) O.D. & 0 degree down angle
Ⓚ 3" (76mm) O.D. & 15 degree down angle
Ⓚ 4" (102mm) O.D.
Ⓚ 2 piece exhaust manifold
Ⓚ 1 piece exhaust manifold
Ⓚ Has a rectangular elbow mounting bolt pattern
Ⓚ Has a square elbow mounting bolt pattern
Ⓚ In-line applications
Ⓚ V-drive applications
Ⓚ Standard rise
Ⓚ 2" (51mm) rise
Ⓚ 3" (76mm) rise
Ⓚ 6" (152mm) rise
Ⓚ Port
Ⓚ Starboard
Ⓚ Engines with risers or closed cooling may require a different gasket than listed
Ⓚ Exhaust manifold with external water rail
Ⓚ Exhaust manifold w/o external water rail
Ⓚ 1 piece exhaust manifold is in-line. Engine must be converted to the 2 piece exhaust system
Ⓚ Engines with easy drain system
Ⓚ Engines with multi-point drain system
Ⓚ Intermediate collector housing

MANIFOLD/MANIFOLD GASKET APPLICATION (Cont.)

Liter	Model	Note	CID	# Cyl	Stroke	Year Range	Serial Number Range	Exh Manifold Port	Exh Manifold Starboard	Exh Elbow	End Cap Front	End Cap Rear	Manifold Gasket	Exh Elbow Gasket
5.7L	350 MAG BRAVO / 350 MAG MPI		350	8	4	1995	F415189 - F601999	18-1953-2	18-1953-2	18-1976-1			18-0872	18-0897
5.7L	350 MAG BRAVO GEN + / 350 MAG MPI GEN +		350	8	4	1996-1997	F602000 - K999999	18-1953-2	18-1953-2	18-1976-1			18-0872	18-0897
5.7L	350 MAG EFI / 350 MAG SKI		350	8	4	1994-1996	F215561 - F820706	18-1953-2	18-1953-2	18-1976-1			18-0872	18-0897
5.7L	350 MAG EFI GEN + / 350 MAG SKI GEN +		350	8	4	1996-1997	F820707 - K999999	18-1953-2	18-1953-2	18-1976-1			18-0872	18-0897
5.7L	350 MAG MPI		350	8	4	1998-2001	L010019 - M299999	18-1953-2	18-1953-2	18-1976-1			18-0872	18-2849
5.7L	350 MAG MPI		350	8	4	2002	M300000 - M599999	18-1953-2	18-1953-2	18-1976-1			18-0872	18-0897
5.7L	350 MAG MPI		350	8	4	2002-2004	M600000 - W309999						18-0872	
5.7L	350 MAG MPI		350	8	4	2004-2010	W310000 & UP						18-0872	
5.7L	350 MAG MPI / 350 MAG HORIZON		350	8	4	2002	M300000 - M599999	18-1953-2	18-1953-2	18-1976-1			18-0872	18-2849
5.7L	350 MAG MPI / 350 MAG HORIZON		350	8	4	2002-2004	M600000 - W309999						18-0872	
5.7L	350 MAG MPI / 350 MAG HORIZON		350	8	4	2004-2007	W310000 - A299999						18-0872	
5.7L	350 MAG MPI / 350 MAG HORIZON / 350 MAG MIE		350	8	4	1999-2001	L304700 - M299999	18-1953-2	18-1953-2	18-1976-1			18-0872	18-2849
5.7L	350 MAG MPI / 350 MAG HORIZON / 350 MAG MIE		350	8	4	2002	M300000 - M316999	18-1953-2	18-1953-2	18-1976-1			18-0872	18-2849
5.7L	350 MAG MPI / 350 MAG HORIZON / 350 MAG MIE		350	8	4	2002-2007	M317000 - A089999						18-0872	
5.7L	350 MAG MPI / 350 MAG MIE		350	8	4	1998-2001	L002008 - M299999	18-1953-2	18-1953-2	18-1976-1			18-0872	18-2849
5.7L	350 MAG MPI / 350 MAG MIE		350	8	4	2002	M300000 - M316999	18-1953-2	18-1953-2	18-1976-1			18-0872	18-0897
5.7L	350 MAG MPI / 350 MAG MIE		350	8	4	2002-2007	M317000 - A089999						18-0872	
5.7L	350 MAG MPI / 350 MAG SKI		350	8	4	1995-1996	F350583 - F799999	18-1953-2	18-1953-2	18-1976-1			18-0872	
5.7L	350 MAG MPI GEN + / 350 MAG SKI GEN +		350	8	4	1998-2001	L002600 - M299999	18-1953-2	18-1953-2	18-1976-1			18-0872	18-2849
5.7L	350 MAG MPI GEN + / 350 MAG SKI GEN +		350	8	4	2002	M300000 - M316999	18-1953-2	18-1953-2	18-1976-1			18-0872	18-0897
5.7L	350 MAG MPI GEN + / 350 MAG SKI GEN +		350	8	4	2002-2007	M317000 - A089999				Ⓢ		18-0872	18-0897
5.7L	350 MAG MPI GEN + / 350 MAG SKI GEN +		350	8	4	2002-2007	M317000 - A089999				Ⓣ		18-0872	
5.7L	350 MAG SKI		350	8	4	1991-1997	D505450 - K999999	18-1953-2	18-1953-2	18-1976-1			18-0872	18-0897
5.7L	5.7L		350	8	4	1988-1997	B773305 - K999999	18-1953-2	18-1953-2	18-1976-1			18-0872	18-0897
5.7L	5.7L GEN +		350	8	4	1998-2002	L010037 - M599999	18-1953-2	18-1953-2	18-1976-1			18-0872	18-2849
5.7L	5.7L GEN +		350	8	4	2002-2004	M600000 - W309999						18-0872	
5.7L	5.7L GEN +		350	8	4	2004-2010	W310000 & UP						18-0872	
5.7L	5.7L EFI		350	8	4	1995-1997	F225560 - K999999	18-1953-2	18-1953-2	18-1976-1			18-0872	18-0897
5.7L	5.7L EFI GEN +		350	8	4	1998-2001	L010035 - M299999	18-1953-2	18-1953-2	18-1976-1			18-0872	18-2849
5.7L	5.7L EFI / 5.7L MIE		350	8	4	1997	K040300 - K999999	18-1953-2	18-1953-2	18-1976-1			18-0872	18-0897
5.7L	5.7L MIE		350	8	4	1988-1997	B788152 - K999999	18-1953-2	18-1953-2	18-1976-1			18-0872	18-0897
5.7L	5.7L MIE GEN +		350	8	4	1998-2002	L002003 - M316999	18-1953-2	18-1953-2	18-1976-1			18-0872	18-2849
5.7L	5.7L MIE GEN +		350	8	4	2002-2010	M317000 & UP						18-0872	
5.7L	5.7L MPI / 5.7L MIE		350	8	4	2008-2010	A090000 & UP						18-0872	
5.7L	5.7L MPI / 5.7L SKI		350	8	4	2008-2010	A090000 & UP					Ⓢ	18-0872	
5.7L	5.7L MPI / 5.7L SKI		350	8	4	2008-2010	A090000 & UP					Ⓣ	18-0872	
5.7L	5.7L SKI		350	8	4	1985-1995	A338553 - F775199	18-1953-2	18-1953-2	18-1970-1			18-0872	18-0897
5.7L	5.7L SKI		350	8	4	1985-1995	A338553 - F775199	18-1953-2	18-1953-2	18-1976-1			18-0872	18-0897
5.7L	5.7L SKI		350	8	4	1996-1997	F775200 - K999999	18-1953-2	18-1953-2	18-1976-1			18-0872	18-0897
5.7L	5.7L SKI		350	8	4	1998-2002	L002005 - M316999	18-1953-2	18-1953-2	18-1976-1			18-0872	18-2849
5.7L	5.7L SKI		350	8	4	2002-2010	M317000 & UP						18-0872	
5.7L	5.7LX		350	8	4	1996-1997	F601000 - K999999	18-1953-2	18-1953-2	18-1976-1			18-0872	18-0897
5.7L	5.7LX BRAVO EFI		350	8	4	1996-1997	F800300 - K999999	18-1953-2	18-1953-2	18-1976-1			18-0872	18-0897
5.7L	5.7LX EFI		350	8	4	1996-1997	F752400 - K999999	18-1953-2	18-1953-2	18-1976-1			18-0872	18-0897
5.7L	BLACK SCORPION SKI		350	8	4	1996-1997	F800000 - K999999	18-1953-2	18-1953-2	18-1976-1			18-0872	18-0897
5.7L	BLACK SCORPION SKI		350	8	4	2003-2007	M391600 - W698432						Ⓢ	18-0872
5.7L	BLACK SCORPION SKI		350	8	4	2003-2007	M391600 - W698432						Ⓣ	18-0872
5.7L	SCORPION 350		350	8	4	2008-2010	W698433 & UP						Ⓢ	18-0872
5.7L	SCORPION 350		350	8	4	2008-2010	W698433 & UP						Ⓣ	18-0872
6.2L	233		351	8	4	1975-1977	4173000 - 4902304	18-1958-1	18-1962-1	18-1971	18-4009	18-4009	18-0183	18-2833
6.2L	233 MIE		351	8	4	1975-1977	4173000 - 4902304	18-1958-1	18-1962-1	N.L.A.	18-4009	18-4009	18-0183	18-2833
6.2L	233 MIE		351	8	4	1975-1977	4173000 - 4902304	18-1958-1	18-1962-1	N.L.A.	18-1990	18-4009	18-0183	18-2833
6.2L	255	FORD	351	8	4	1973-1974	3258728 - 4175499	18-1958-1	18-1962-1	18-1971	18-4009	18-4009	18-0183	18-2833
6.2L	255 MIE	FORD	351	8	4	1973-1974	3258728 - 4175499	18-1958-1	18-1962-1	18-1971	18-4009	18-4009	18-0183	18-2833
6.2L	225 MIE	FORD	351	8	4	1973-1974	3258728 - 4175499	18-1958-1	18-1962-1	18-1971	18-1990	18-4009	18-0183	18-2833
6.2L	377 MAG		377	8	4	2008-2010	A300000 & UP						18-0872	
6.2L	377 SCORPION MCM		377	8	4	1999-2005	L416146 - M907201	18-1953-2	18-1953-2	18-1976-1			18-0872	18-2849
6.2L	377 SCORPION SKI		377	8	4	1997-1998	K000656 - L600314	18-1953-2	18-1953-2	18-1976-1			18-0872	18-0897
6.2L	MX 6.2L MPI		377	8	4	2000-2001	L680003 - M299999	18-1953-2	18-1953-2	18-1976-1			18-0872	18-2849
6.2L	MX 6.2L MPI		377	8	4	2002	M300000 - M599999	18-1953-2	18-1953-2	18-1976-1			18-0872	18-0897
6.2L	MX 6.2L MPI		377	8	4	2002-2004	M600000 - W309999						18-0872	
6.2L	MX 6.2L MPI		377	8	4	2004-2007	W310000 - A299999						18-0872	
6.2L	MX 6.2L MPI / MX 6.2L HORIZON		377	8	4	2002	M300000 - M599999	18-1953-2	18-1953-2	18-1976-1			18-0872	18-2849
6.2L	MX 6.2L MPI / MX 6.2L HORIZON		377	8	4	2002-2004	M600000 - W309999						18-0872	
6.2L	MX 6.2L MPI / MX 6.2L HORIZON		377	8	4	2004-2007	W310000 - A299999						18-0872	
6.2L	MX 6.2L MPI / MX 6.2L HORIZON / MX 6.2L MIE		377	8	4	2002	M300000 - M316999	18-1953-2	18-1953-2	18-1976-1			18-0872	18-2849
6.2L	MX 6.2L MPI / MX 6.2L HORIZON / MX 6.2L MIE		377	8	4	2002-2007	M317000 - A089999						18-0872	
6.2L	MX 6.2L MPI / MX 6.2L MIE		377	8	4	1999-2001	L670000 - M299999	18-1953-2	18-1953-2	18-1976-1			18-0872	18-2849
6.2L	MX 6.2L MPI / MX 6.2L MIE		377	8	4	2002	M300000 - M316999	18-1953-2	18-1953-2	18-1976-1			18-0872	18-0897
6.2L	MX 6.2L MPI / MX 6.2L MIE		377	8	4	2002-2010	M317000 & UP						18-0872	

- Ⓛ For engines with aluminum exhaust manifolds
- Ⓛ For engines with cast iron exhaust manifolds
- Ⓢ 3" (76mm) O.D. & 0 degree down angle
- Ⓣ 3" (76mm) O.D. & 15 degree down angle
- Ⓛ 4" (102mm) O.D.
- Ⓢ 2 piece exhaust manifold
- Ⓣ 1 piece exhaust manifold
- Ⓢ Has a rectangular elbow mounting bolt pattern
- Ⓣ Has a square elbow mounting bolt pattern

- Ⓛ In-line applications
- Ⓣ V-drive applications
- Ⓢ Standard rise
- Ⓣ 2" (51mm) rise
- Ⓢ 3" (76mm) rise
- Ⓣ 6" (152mm) rise
- Ⓛ Port
- Ⓣ Starboard
- Ⓢ Engines with risers or closed cooling may require a different gasket than listed

- Ⓢ Exhaust manifold with external water rail
- Ⓣ Exhaust manifold w/o external water rail
- Ⓢ 1 piece exhaust manifold is nla. Engine must be converted to the 2 piece exhaust system
- Ⓛ Engines with easy drain system
- Ⓢ Engines with multi-point drain system
- Ⓣ Intermediate collector housing

MANIFOLD/MANIFOLD GASKET APPLICATION (Cont.)

Table with columns: Liter, Model, Note, CID, # Cyl, Stroke, Year Range, Serial Number Range, Exh Manifold Port, Exh Manifold Starboard, Exh Elbow, End Cap Front, End Cap Rear, Manifold Gasket, Exh Elbow Gasket. Rows list various engine models and their corresponding gasket part numbers.

- For engines with aluminum exhaust manifolds
● For engines with cast iron exhaust manifolds
● 3" (76mm) O.D. & 0 degree down angle
● 3" (76mm) O.D. & 15 degree down angle
● 4" (102mm) O.D.
● 2 piece exhaust manifold
● 1 piece exhaust manifold
● Has a rectangular elbow mounting bolt pattern
● Has a square elbow mounting bolt pattern

- In-line applications
● V-drive applications
● Standard rise
● 2" (51mm) rise
● 3" (76mm) rise
● 6" (152mm) rise
● Port
● Starboard
● Engines with risers or closed cooling may require a different gasket than listed

- Exhaust manifold with external water rail
● Exhaust manifold w/o external water rail
● 1 piece exhaust manifold is n/a. Engine must be converted to the 2 piece exhaust system
▲ Engines with easy drain system
▲ Engines with multi-point drain system
▼ Intermediate collector housing

## Features...

- Manufactured to meet or exceed OEM specifications.
- High Efficiency Filter
- Field-tested and approved.
- Anti-drainback valves where required.



### OIL FILTERS

- ① Do not use on V-6 engines equipped with remote oil filter kit
- Display Packaged

SEE PAGES 152-154 FOR ADDITIONAL INFORMATION

Part #	O.E. #	Application
18-7824-1*	54111, 14957, 32716, 35-802885Q, 35-866340K01, 35-866340Q03	GM Engines ① (Short Filter)
18-7871	35-805809, T	D7.3L Diesel
18-7875*	60565, 35-802886Q	Ford Engines (Long Filter)
18-7876*	52731, 35-16595T, T1, Q, 32-802885Q, 14957	GM Engines (Long Filter)
18-7878-1*	803470, Q	60 & 80 HP Engines (Renault) (Short Filter)
18-7879*	41815, 35-802884Q, 35-883702Q, K	GM V-6 Engines

## OIL PANS AND GASKET



**18-1232**  
**OIL PAN GASKET**  
Replaces: 27-811566



Part No.	OE	OE No.	Application
18-0612	MerCruiser	809910	1 piece rear main seal; GM Small Block V8 (Right Handed Dipstick)
18-0613	MerCruiser	93476	2 piece rear main seal; GM Small Block V8 (Right Handed Dipstick)
18-0614	MerCruiser	845668T	1 piece rear main seal; GM Big Block V8 (Right Handed Dipstick)
18-0615	MerCruiser	93477T	2 piece rear main seal; GM Big Block V8 (Right Handed Dipstick)
18-0616	MerCruiser	14244T	1 piece rear main seal; GM V6 (Right Handed Dipstick)

## CYLINDER HEAD ASSEMBLIES

All cylinder heads are new castings and complete assemblies with new- stainless steel valves, hardened steel exhaust seats, valve springs, valve locks, and retainers.  
All GM cylinder heads utilize high performance screw-in rocker arm studs in place of factory press in rocker arm studs.



**18-4484**  
**CYLINDER HEAD ASSEMBLY**  
Fits: 5.7L V-8 GM (1969-86) with 12 intake manifold mounting bolts, perimeter mount valve cover



**18-4485**  
**CYLINDER HEAD ASSEMBLY**  
Replaces: 938-883490 1  
Fits: 5.7L V-8 GM (1987-95) with press in rocker arm studs with 12 intake manifold mounting bolts- (4 inside intake manifold bolts at 23 degrees), center mount valve covers



**18-4486**  
**CYLINDER HEAD ASSEMBLY**  
Replaces: 938-883297 1, 938-803860T  
Fits: 5.7L V-8 GM Vortec (1996-Up) with press in rocker arm studs with 8 intake manifold mounting bolts, composite valve cover



**18-4489**  
**CYLINDER HEAD ASSEMBLY**  
Replaces: 936-5544, 936-810840  
Fits: 2.5L/3.0L GM (1968-95) (non MerCruiser LX models) (1968-95)



**18-4491**  
**CYLINDER HEAD ASSEMBLY**  
Replaces: 938-827178 1  
Replaces 4.3L Vortec V-6 (1996-Up) with screw in rocker arm studs (non-adjustable valve train), 8 intake manifold mounting bolts, center mount valve cover. NOTE: not for use with engines using factory roller rocker arms.



**18-4495**  
**CYLINDER HEAD ASSEMBLY**  
Replaces: 949-4057, 949-5798  
Fits: (1980& Up) 5.0L Ford with D-shape 58 cc combustion chamber



**18-4501**  
**CYLINDER HEAD**  
Fits: 5.0L Vortec



**18-4502**  
**CYLINDER HEAD**  
**High Performance**  
Aluminum cylinder head sold in pairs only. This utilizes a 185cc intake runner/62cc exhaust runner and 2.02/1.60 stainless valves placed in a 72cc combustion chamber.  
Fits: 5.7, 6.2L GM small block V-8



**18-4492  
ROCKER ARM ASSEMBLY**  
Replaces: 35329  
Fits: MCM/MIE Gm V6 & V8(283, 305 & 350 cid) engines



**18-7508  
POWER STEERING PUMP**  
Replaces: 16792A39



**18-8227  
POWER STEERING PUMP PULLEY**  
Replaces: 73873A1  
For: Sterndrives with v-belt



**18-8297  
POWER STEERING PUMP PULLEY**  
Replaces: 861578  
For: Sterndrives with serpentine belt



**18-1400  
HYDRAULIC LIFTER**  
Replaces: 17340  
GM 4.3L/V-6 Late/5.0L/5.7L



**18-1401  
HYDRAULIC LIFTER**  
Replaces: 56153  
Ford 302/351  
Ford 5.0L & 5.8L



**18-1402  
HYDRAULIC LIFTER**  
Replaces: 72638  
GM 2.5L/120  
For: Mercruiser 140 (S/N 2508261-6229717),  
140/3.0L (S/N 6229718-up), 3.0L/3.0LX (S/N C856559-up)

**ALL PISTONS  
ARE SUPPLIED COMPLETE WITH PISTON RINGS AND WRIST PIN.**



**PISTONS**

STD	REPLACES MERCUISER
18-4180	736-2343
18-4161	733-3819 733-803850T
18-4109	778-9441A3 759-80661A7
18-4173	735-6370 735-9686 735-808674 735-850097
<b>.020</b>	
18-4160	733-3818
<b>.030</b>	
18-4134	778-9441A5 759-80661A8
18-4164	735-6371 735-9687 735-850098
18-4178	735-9715

**RINGS**

STD	REPLACES MERCUISER
18-3928	39-74381A1
18-3937	39-17464
18-3940	39-67127
18-3942	39-67132
18-3944	39-75609
<b>.020</b>	
18-3939	39-66217
<b>.030</b>	
18-3938	39-17465



## PISTON/ RING APPLICATION

Liter	Model	Note	CID	# Cyl	Stroke	Year	Serial Number	PISTONS			RINGS			Qty. Eng.
								Std.	0.02	0.03	Note	Std.	0.02	
1.6L	100 VASER		98	4	4	2007-2010	W995000 & UP	-	-	-	-	-	-	
2.5L	120		153	4	4	1964-1986	1666601 - B531853	18-4180	-	-	-	-	-	
2.5L	153		153	4	4	1987-1989	B531854 - C853255	18-4180	-	-	-	-	-	
3.0L	140		181	4	4	1968-1986	2508261 - B450800	18-4161	18-4160	18-4191	18-3937	18-3939	18-3938	4
3.0L	140						3332138 - 5157668	18-4161	18-4160	18-4191	18-3937	18-3939	18-3938	4
3.0L	140						5157669 - 6229717	18-4161	18-4160	18-4191	18-3937	18-3939	18-3938	4
3.0L	140 / 3.0L						6229718 - C856558	18-4161	18-4160	18-4191	18-3937	18-3939	18-3938	4
3.0L	3.0L		181	4	4	1987-1989	B450801 - C856558	18-4161	18-4160	-	-	-	-	
3.0L	3.0L		181	4	4	1990-1994	C856559 - F603999	-	-	-	18-3937	18-3939	18-3938	6
3.0L	3.0L		181	4	4	1998-2010	L010042 & UP	-	-	-	-	-	-	
3.0L	3.0L MPI		181	4	4	2008-2010	A072812 & UP	-	-	-	-	-	-	
3.0L	3.0LX		181	4	4	1990-1997	C856559 - K999999	-	-	-	-	-	-	
3.7L	165 / 3.7L		224	4	4	1987-1989	B434941 - C762299	-	-	(11)	18-4134	-	-	
3.7L	170		224	4	4	1985-1986	6916779 - B434940	18-4109	18-4118	-	18-4134	18-3928	18-3929	4
3.7L	180 / 3.7LX		224	4	4	1987-1989	B436391 - C762299	18-4109	-	(11)	18-4134	-	-	
3.7L	190 / 3.7L		224	4	4	1985-1986	6916779 - B436390	18-4109	-	(11)	18-4134	-	-	
3.7L	470		224	4	4	1976-1984	4208730 - 6916779	18-4109	18-4118	-	18-4134	18-3928	18-3929	4
3.7L	485		224	4	4	1980-1982	5685394 - 6218036	18-4109	-	(11)	18-4134	-	-	
3.7L	488		224	4	4	1983-1984	6170297 - 6916778	18-4109	-	(11)	18-4134	-	-	
	150						1666495 - 2048046	18-4180	18-4183	-	-	18-3942	-	6
4.1L	160		250	6	4	1987-1989	2048022 - 2770031	-	-	-	18-3942	-	-	
4.1L	165		250	6	4	1970-1981	2770032 - 5813433	-	-	-	18-3942	-	-	
4.3L	175 / 4.3L						B527955 - & Up	18-4173	18-4188	18-4164	18-3937	18-3939	18-3938	6
3.8L	185	2bb1					6330183 - 6919655	-	-	-	18-3944	-	-	
4.3L	175 / 4.3L		262	6	4	1987-1992	B527955 - D714106	-	-	-	-	-	-	
4.3L	185	2bb1	262	6	4	1985-1986	A331455 - B527954	-	-	18-4164	18-3937	18-3939	-	
4.3L	205 / 4.3LX		262	6	4	1985-1986	A331455 - B527954	-	-	18-4164	18-3937	18-3939	18-3938	
4.3L	262 MAG EFI GEN +		262	6	4	1987-1991	B527955 - D714369	18-4173	-	-	-	-	-	
4.3L	262 MAG EFI GEN +		262	6	4	1996-1997	F803800 - K999999	-	-	-	-	-	-	
4.3L	4.3L GEN II		262	6	4	1992-1996	D714107 - F802999	18-4173	18-4188	-	-	-	18-3938	6
4.3L	4.3L GEN +		262	6	4	1998-2010	L010044 & UP	-	-	-	-	-	-	
4.3L	4.3L EFI GEN +		262	6	4	1998-2001	L012009 - M299999	-	-	-	-	-	-	
4.3L	4.3L MPI		262	6	4	2002-2010	M322761 & UP	-	-	-	-	-	-	
4.3L	4.3LH GEN +		262	6	4	1998-2002	L010044 - M614999	-	-	-	-	-	-	
4.3L	4.3LX GEN II		262	6	4	1992-1996	D7141370 - F802999	-	-	18-4164	18-3937	18-3939	18-3938	6
4.3L	4.3LX GEN +		262	6	4	1996-1997	F803000 - K999999	-	-	-	-	-	-	
4.3L	4.3LXH GEN +		262	6	4	1996-1997	F803114 - K999999	-	-	-	-	-	-	
4.9L	215	FORD	302	8	4	1970-1972	2781153 - 3395720	-	-	-	18-3937	18-3939	18-3938	8
4.9L	215	FORD					3385721 - 4166999	-	-	-	18-3937	18-3939	18-3938	8
	225	GM					1536920 - & Up	-	-	-	18-3937	18-3939	18-3938	8
4.6L	190	GM	283	8	4	1963-1964	1564539 - 1730903	18-4180	18-4183	-	18-3942	-	-	6
5.0L	198 MIE		305	8	4	1977	4776402 - 4931099	-	-	-	-	-	-	
5.0L	200		305	8	4	1985-1987	6899058 - B525981	-	-	-	-	-	-	
5.0L	200 / 5.0L	GM	305	8	4	1987	B525982 - B774444	-	-	18-4178	18-3944	-	-	8
	200	GM					6218462 - & Up	-	-	-	18-3944	-	-	8
5.0L	228	GM	305	8	4	1977-1984	4765100 - 6899268	-	-	-	18-3944	-	-	8
5.0L	228 MIE		305	8	4	1977-1980	5170009 - 5907057	-	-	-	-	-	-	
5.0L	230		305	8	4	1985-1987	6899269 - B525981	-	-	-	-	-	-	
5.0L	230		305	8	4	1987-1995	B525982 - B773739	-	-	18-4178	18-3944	-	-	8
5.0L	230 MIE	GM	305	8	4	1981-1987	5907058 - B522505	-	-	-	18-3944	-	-	8
5.0L	230 MIE		305	8	4	1987	B522506 - B788151	-	18-4530	18-4178	18-3944	-	-	8
5.0L	230 GM						6218462 - & Up	-	-	-	18-3944	-	-	8
5.0L	5.0L		305	8	4	1988-1995	B774445 - F600999	-	-	-	-	-	-	
5.0L	5.0L GEN +		305	8	4	1998-2010	L015751 & UP	-	-	-	-	-	-	
5.0L	5.0L EFI GEN +		305	8	4	1998-2001	L012052 - M299999	-	-	-	-	-	-	
5.0L	5.0L MIE		305	8	4	1988	B788152 - C396832	-	-	-	-	-	-	
5.0L	5.0L MPI		305	8	4	2002-2010	M300000 & UP	-	-	-	-	-	-	
5.0L	5.0LX		305	8	4	1988-1995	B773740 - F600999	-	-	-	-	-	-	
5.0L	898 / 198	GM	305	8	4	1977-1984	4762210 - 6899057	-	-	-	18-3944	-	-	8
5.4L	225 MCM / 225 MIE	GM	327	8	4	1963-1969	1539620 - 2694014	-	-	-	-	-	-	
5.4L	250 MCM - 250 MIE	GM	327	8	4	1968-1969	2314301 - 2639854	-	-	-	18-3937	18-3939	18-3938	8
5.7L	250	GM	350	8	4	1977	4768000 - 4908849	18-4173	18-4188	18-4164	18-3937	18-3939	18-3938	8
5.7L	255	GM	350	8	4	1975-1976	4175500 - 4767999	18-4173	18-4188	18-4164	18-3937	18-3939	18-3938	8
5.7L	255 MIE	GM	350	8	4	1975-1980	4175500 - 5907057	18-4173	-	-	-	-	-	8
5.7L	260	GM	350	8	4	1978-1987	4908850 - B773304	18-4173	18-4188	18-4164	18-3937	18-3939	18-3938	8
5.7L	260 MIE	GM	350	8	4	1981-1987	5907058 - B788151	18-4173	18-4188	18-4164	18-3937	18-3939	18-3938	8
5.7L	260 / 5.7L	GM	350	8	4		B525982 - & Up	18-4173	18-4188	18-4164	18-3937	18-3939	18-3938	8
5.7L	270 MCM / 270 MIE		350	8	4	1969-1972	2851074 - 3077735	-	-	-	18-3937	18-3939	18-3938	8
5.7L	280		350	8	4	1975-1976	4176250 - 4770199	-	-	-	-	-	-	8
5.7L	300		350	8	4	1985-1988	6668677 - B430367	-	-	-	18-3937	18-3939	18-3938	8
5.7L	320 EFI		350	8	4	1987-1989	A543604 - C622418	-	-	-	18-3937	18-3939	18-3938	8
5.7L	320 GM EFI BRAVO						B157603 - & Up	-	-	-	18-3937	18-3939	18-3938	8
	325	GM					2278747 - & Up	-	-	-	18-3940	18-3950	18-3941	8
	330	GM					4623115 - & Up	-	18-4189	-	18-3940	18-3950	18-3941	8
	330 W/B.W.	GM					6083145 - & Up	-	18-4189	-	18-3940	18-3950	18-3941	8
5.7L	350 MAG ALPHA		350	8	4	1986-1997	A635178 - K999999	18-4173	18-4188	18-4164	18-3937	18-3939	18-3938	8
5.7L	350 MAG ALPHA EFI GEN +		350	8	4	1996-1997	F800300 - K999999	-	-	-	-	-	-	8
5.7L	350 MAG BRAVO MPI		350	8	4	1995	F415189 - F601999	18-4173	-	18-4164	-	-	-	8
5.7L	350 MAG BRAVO MPI GEN +		350	8	4	1996-1997	F602000 - K999999	-	-	-	-	-	-	8
5.7L	350 MAG SKI		350	8	4	1994-1996	F215561 - F820706	18-4173	-	18-4164	-	-	-	8

- (1) Cast Aluminum (Use with GM Engine Code 1XW)
- (2) Cast aluminum (Use with GM Engine Code 4XW)
- (3) Forged Aluminum (Use with GM Engine Code 3UB)
- (4) Cast Aluminum (Use with GM Engine Code 4XX)
- (5) Cast Aluminum (Use with GM Engine Code 2XY)
- (6) Cast Aluminum (Use with GM Engine Code 4XY)

- (7) Flat Head
  - (8) Forged Aluminum, Recessed Head
  - (9) Starboard
  - (10) Port
  - (11) .010 (25mm)Oversize
- N.L.A. No longer available from O.E. source

## PISTON/ RING APPLICATION

Liter	Model	Note	CID	# Cyl	Stroke	Year	Serial Number	PISTONS			RINGS			Qty. Eng.	
								Std.	Note	0.02	0.03	Note	Std.		0.02
5.7L	350 MAG EFI SKI GEN +		350	8	4	1996-1997	F820707 - K999999	-	-	-	-	-	-	8	
5.7L	350 MAG MPI GEN +		350	8	4	1998-2010	L010019 & UP	-	-	-	-	-	-	8	
5.7L	350 MAG MPI / 350 MAG HORIZON		350	8	4	2002-2007	M300000 - A299999	-	-	-	-	-	-	8	
5.7L	350 MAG MPI / 350 MAG HORIZON / 350 MAG MIE		350	8	4	1998-2007	L304700 - A89999	-	-	-	-	-	-	8	
5.7L	350 MAG / 350 MAG MIE / 350 MAG MPI GEN +		350	8	4	1998-2007	L002008 - A089999	-	-	-	-	-	-	8	
5.7L	350 MAG MPI SKI		350	8	4	1995-1996	F350583 - F799999	18-4173	-	-	18-4164	-	-	-	8
5.7L	350 MAG MPI SKI GEN +		350	8	4	1998-2007	L002600 - A089999	-	-	-	-	-	-	-	8
5.7L	350 MAG SKI		350	8	4	1991-1997	D505450 - K999999	18-4173	18-4188	18-4164	18-3937	18-3939	18-3938	8	
5.7L	350	GM	350	8	4		3780450 - & Up	-	-	-	18-3940	18-3950	18-3941	8	
5.7L	350 MAG	GM	350	8	4		B525982 - & Up	18-4173	18-4188	18-4164	18-3937	18-3939	18-3938	8	
5.7L	5.7L		350	8	4	1988-1995	B773305 - F600999	18-4173	-	18-4164	-	-	-	8	
5.7L	5.7L	2bb1	350	8	4	1996-1997	F601000 - K999999	18-4173	-	-	-	-	-	8	
5.7L	5.7L GEN +		350	8	4	1998-2010	L010037 & UP	-	-	-	-	-	-	8	
5.7L	5.7L EFI		350	8	4	1995-1997	F225560 - K999999	18-4173	-	18-4164	-	-	-	8	
5.7L	5.7L EFI GEN +		350	8	4	1998-2001	L010035 - M299999	-	-	-	-	-	-	8	
5.7L	5.7L EFI MIE GEN +		350	8	4	1997	K040300 - K999999	-	-	-	-	-	-	8	
5.7L	5.7L MIE		350	8	4	1988-1997	B788152 - K999999	18-4173	-	18-4164	-	-	-	8	
5.7L	5.7L MIE GEN +		350	8	4	1998-2010	L002003 & UP	-	-	-	-	-	-	8	
5.7L	5.7L MPI / 5.7L HORIZON / 5.7L MIE		350	8	4	2008-2010	A090000 & UP	-	-	-	-	-	-	8	
5.7L	5.7L MPI / 5.7L MIE		350	8	4	2008-2010	A090000 & UP	-	-	-	-	-	-	8	
5.7L	5.7L MPI / 5.7L SKI		350	8	4	2008-2010	A090000 & UP	-	-	-	-	-	-	8	
5.7L	5.7L SKI		350	8	4	1985-1997	A338553 - K999999	18-4173	-	18-4164	-	-	-	8	
5.7L	5.7L SKI GEN +		350	8	4	1998-2010	L002005 & UP	-	-	-	-	-	-	8	
5.7L	5.7L X		350	8	4	1996-1997	F601000 - K999999	18-4173	-	18-4164	-	-	-	8	
5.7L	5.7LX BRAVO EFI GEN +		350	8	4	1996-1997	F800300 - K999999	-	-	-	-	-	-	8	
5.7L	5.7LX EFI		350	8	4	1996-1997	F752400 - K999999	18-4173	-	18-4164	-	-	-	8	
5.7L	BLACK SCORPION SKI GEN +		350	8	4	1998-2007	F800000 - W6988432	-	-	-	-	-	-	8	
5.7L	SCORPION 350		350	8	4	2008-2010	W698432 & UP	-	-	-	-	-	-	8	
5.8L	233	FORD	351	8	4	1975-1977	4173000 - 4902304	-	-	-	-	-	-	8	
5.8L	255	FORD	351	8	4	1973-1974	3258728 - 4175499	-	-	-	-	-	-	8	
6.2L	377 MAG		377	8	4	2008-2009	A000000 - A345479	-	-	-	-	-	-	8	
6.2L	377 MAG		377	8	4	2009	A345480 - A345492	-	-	-	-	-	-	8	
6.2L	377 MAG		377	8	4	2009	A345493 - A345765	-	-	-	-	-	-	8	
6.2L	377 MAG		377	8	4	2009	A345766 - A345767	-	-	-	-	-	-	8	
6.2L	377 MAG		377	8	4	2009	A345768 - A346789	-	-	-	-	-	-	8	
6.2L	377 MAG		377	8	4	2009-2010	A346790 & UP	-	-	-	-	-	-	8	
6.2L	377 SCORPION STERNDRIIVE		377	8	4	2000-2010	L416146 & UP	-	-	-	-	-	-	8	
6.2L	377 SCORPION SKI		377	8	4	1997-1998	K000656 - L600314	-	-	-	-	-	-	8	
6.2L	MX 6.2L MPI		377	8	4	2000-2007	L680003 - A299999	-	-	-	-	-	-	8	
6.2L	MX 6.2L MPI / MX 6.2L MIE		377	8	4	2002-2009	M300000 - A091825	-	-	-	-	-	-	8	
6.2L	MX 6.2L MPI / MX 6.2L MIE		377	8	4	2009-2010	A091826 & UP	-	-	-	-	-	-	8	
6.2L	MX 6.2L MPI / MX 6.2L SKI		377	8	4	2002-2007	M317000 - W689999	-	-	-	-	-	-	8	
6.2L	MX 6.2L BLACK SCORPION SKI		377	8	4	2001-2007	L670015 - W698432	-	-	-	-	-	-	8	
6.2L	SCORPION 377		377	8	4	2008-2009	W698826 & UP	-	-	-	-	-	-	8	
6.2L	SCORPION 377 HO / SCORPION 377 EC		377	8	4	2009-2010	A091488 - A092170	-	-	-	-	-	-	8	
7.4L	325 MCM / 325 MIE		454	8	4	1969-1972	2278747 - 3780449	-	-	-	-	-	-	8	
7.4L	330		454	8	4	1977-1987	4623115 - B816540	-	-	-	-	-	-	8	
7.4L	330 MIE		454	8	4	1977-1980	4623115 - 5779913	-	-	-	-	-	-	8	
7.4L	340 MIE		454	8	4	1981-1987	5889914 - B788365	-	18-4189	-	18-3940	18-3950	18-3941	8	
7.4L	350 MIE		454	8	4	1974-1976	3780450 - 4623109	-	-	-	-	-	-	8	
7.4L	370 TRS		454	8	4	1978-1987	4179554 - B714596	-	-	-	18-3940	18-3950	18-3941	8	
7.4L	390	GM	454	8	4		2781129 - 2825059	-	-	-	18-3940	18-3950	18-3941	8	
7.4L	400 TRS		454	8	4	1980-1986	4179554 - B457644	-	-	-	18-3940	18-3950	18-3941	8	
7.4L	420		454	8	4	1987-1989	A398941 - B6222418	-	-	-	18-3940	18-3950	18-3941	8	
7.4L	425		454	8	4	1990-1992	B622419 - D725499	-	-	-	18-3940	18-3950	18-3941	8	
7.4L	425 GEN V		454	8	4	1992-1993	D725500 - D937011	-	-	-	-	-	-	8	
7.4L	440 TRS		454	8	4	1983-1986	4179554 - B485220	-	-	-	18-3940	18-3950	18-3941	8	
7.4L	450 GEN V		454	8	4	1995-1996	F347100 - F347277	-	-	-	-	-	-	8	
7.4L	454 MAG ALPHA		454	8	4	1986-1988	A631894 - B785148	-	18-4189	-	18-3940	18-3950	18-3941	8	
7.4L	454 MAG BRAVO		454	8	4	1988-1992	D721206 - D805068	-	-	-	-	-	-	8	
7.4L	454 MAG BRAVO GEN V		454	8	4	1992-1996	D805069 - F801699	-	-	-	-	-	-	8	
7.4L	454 MAG BRAVO GEN VI		454	8	4	1996-1997	F801700 - K999999	-	-	-	-	-	-	8	
7.4L	454 MAG EFI GEN V		454	8	4	1994-1996	F115700 - F802349	-	-	-	-	-	-	8	
7.4L	454 MAG EFI SKI GEN V		454	8	4	1995-1996	F215800 - F820099	-	-	-	-	-	-	8	
7.4L	454 MAG MPI GEN VI		454	8	4	1996-2001	F802350 - M0224999	-	-	-	-	-	-	8	
7.4L	454 MAG MPI / 454 MAG HORIZON / 454 MAG MIE		454	8	4	1998-2001	L002200 - L674000	-	-	-	-	-	-	8	
7.4L	454 MAG MPI SKI GEN VI		454	8	4	1996-1997	F820100 - K999999	-	-	-	-	-	-	8	
7.4L	454 MAG BRAVO		454	8	4		B840126 - & Up	-	-	-	18-3940	18-3950	18-3941	8	
	470		454	8	4		4208730 - & Up	18-4109	18-4118	18-4134	18-3928	18-3929	-	4	
	485		454	8	4		5685394 - & Up	18-4109	18-4118	18-4134	18-3928	18-3929	-	4	
	488		454	8	4		6170297 - & Up	18-4109	18-4118	18-4134	18-3928	18-3929	-	4	
	525 SC		454	8	4	1991-1992	D456000 - D725808	-	-	-	-	-	-	8	
7.4L	525 SC GEN V		454	8	4	1992-1996	D763746 - F348963	-	-	-	-	-	-	8	
7.4L	525 SC GEN V		454	8	4	1996-1999	F615814 - L415623	-	-	-	-	-	-	8	

- (1) Cast Aluminum (Use with GM Engine Code 1XW)  
(2) Cast aluminum (Use with GM Engine Code 4XW)  
(3) Forged Aluminum (Use with GM Engine Code 3UB)  
(4) Cast Aluminum (Use with GM Engine Code 4XX)  
(5) Cast Aluminum (Use with GM Engine Code 2XY)  
(6) Cast Aluminum (Use with GM Engine Code 4XY)

- (7) Flat Head  
(8) Forged Aluminum, Recessed Head  
(9) Starboard  
(10) Port  
(11) .010 (25mm) Oversize

N.L.A. No longer available from O.E. source



# PISTON/RING APPLICATION

Liter	Model	Note	CID	# Cyl	Stroke	Year	Serial Number	PISTONS			RINGS			Qty. Eng.	
								Std.	Note	0.02	0.03	Note	Std.		0.02
7.4L	7.4L BRAVO		454	8	4	1988-1991	B771113 - D603117	-	-	-	-	-	-	8	
7.4L	7.4L BRAVO I GEN V / 7.4L BRAVO II GEN V		454	8	4	1992-1995	D603118 - F800699	-	1	-	-	-	-	8	
7.4L	7.4L BRAVO I GEN V / 7.4L BRAVO II GEN V		454	8	4	1992-1996	D603118 - F800699	-	2	-	-	-	-	8	
7.4L	7.4L BRAVO III GEN V		454	8	4	1992-1995	D603118 - F800699	-	3	-	-	-	-	8	
7.4L	7.4L BRAVO III GEN V		454	8	4	1992-1996	D603118 - F800699	-	4	-	-	-	-	8	
7.4L	7.4L BRAVO GEN VI		454	8	4	1996-1997	F800700 - K999999	-	-	-	-	-	-	8	
7.4L	7.4L EFI GEN VI / 7.4L MIE GEN VI / 7.4L GEN VI MIE		454	8	4	1996-1997	F874815 - K999999	-	-	-	-	-	-	8	
7.4L	7.4L MIE W/HURTH		454	8	4	1988-1992	B788366 - D715493	-	-	-	-	-	-	8	
7.4L	7.4L W/HURTH		454	8	4		C391564 - & Up	-	-	18-4189	-	18-3940	18-3950	18-3941	8
7.4L	7.4L MIE GEN V		454	8	4	1992-1995	D715494 - F820141	-	5	-	-	-	-	8	
7.4L	7.4L MIE GEN V		454	8	4	1992-1996	D715494 - F820141	-	5	-	-	-	-	8	
7.4L	7.4L MIE GEN VI		454	8	4	1996-1997	F820142 - K999999	-	-	-	-	-	-	8	
7.4L	7.4L MPI GEN VI		454	8	4	1998-2001	L010003 - M024330	-	-	-	-	-	-	8	
7.4L	7.4L MPI GEN V / 7.4L MIE GEN V		454	8	4	1995-1996	F563052 - F820103	-	-	-	-	-	-	8	
7.4L	7.4L MPI GEN VI / 7.4L MIE GEN VI / 7.4LH GEN VI		454	8	4	1996-1997	F820104 - K999999	-	-	-	-	-	-	8	
7.4L	7.4L MPI L-29 GEN VI / 7.4L MIE L-29 GEN VI		454	8	4	1998-2001	L002006 - M025999	-	-	-	-	-	-	8	
7.4L	7.4LX BRAVO GEN VI / 7.4L BRAVO EFI		454	8	4	1996-1997	F802000 - K999999	-	-	-	-	-	-	8	
7.4L	7.4LX BRAVO GEN V / 7.4L MPI GEN V		454	8	4	1996	F802010 - F801999	-	-	-	-	-	-	8	
7.4L	7.4LX BRAVO GEN VI / 7.4L MPI GEN VI		454	8	4	1996-1997	F802000 - K999999	-	-	-	-	-	-	8	
7.9L	390		482	8	4	1969-1970	2781129 - 2825059	-	-	-	-	-	-	8	
7.9L	460 TRS		482	8	4	1983-1986	4179554 - 6181046	-	-	-	-	-	-	8	
8.1L	496		482	8	4	2001-2010	M025000 & UP	-	9	-	-	-	-	8	
8.1L	496		496	8	4	2001-2010	M025000 & UP	-	10	-	-	-	-	8	
8.2L	465		502	8	4	1990-1992	C849992 - D725646	-	-	-	-	-	-	8	
8.2L	465 GEN V		502	8	4	1992-1994	D725647 - F213244	-	-	-	-	-	-	8	
8.2L	500 GEN V		502	8	4	1994-1996	F213293 - F745159	-	-	-	-	-	-	8	
8.2L	500 GEN VI		502	8	4	1997-1999	K745195 - L601036	-	-	-	-	-	-	8	
8.2L	500 EFI		502	8	4	1999-2005	L001477 - M907127	-	-	-	-	-	-	8	
8.2L	502 MAG BRAVO		502	8	4	1990-1992	C878221 - D824588	-	-	-	-	-	-	8	
8.2L	502 MAG BRAVO GEN V		502	8	4	1992-1993	D824589 - F114528	-	-	-	-	-	-	8	
8.2L	502 MAG EFI		502	8	4	1993-1996	D640650 - F802599	-	-	-	-	-	-	8	
8.2L	502 MAG MPI GEN VI		502	8	4	1996-2001	F802600 - M024999	-	-	-	-	-	-	8	
8.2L	525 EFI		502	8	4	2003-2010	M900146 & UP	-	-	-	-	-	-	8	
8.2L	575 Sci		502	8	4	2001-2005	L306696 - M950526	-	-	-	-	-	-	8	
8.2L	600 SC		502	8	4	1991-1992	D456489 - D456768	-	-	-	-	-	-	8	
8.2L	600 SC GEN V		502	8	4	1992-1996	D725676 - F877642	-	-	-	-	-	-	8	
8.2L	600 SC GEN VI		502	8	4	1997-2000	K000227 - L601186	-	-	-	-	-	-	8	
8.2L	8.2L MAG EC		502	8	4	2010	A350340 & UP	-	-	-	-	-	-	8	
8.2L	8.2L MIE / 8.2L EC		502	8	4	2010	A350802 & UP	-	-	-	-	-	-	8	
8.2L	8.2L MIE W/HURTH		502	8	4	1990-1992	C878221 - D857199	-	-	-	-	-	-	8	
8.2L	8.2L MIE GEN V		502	8	4	1993-1995	D857200 - F819619	-	-	-	-	-	-	8	
8.2L	8.2L MPI GEN VI / 8.2L MIE GEN VI / 8.2LH GEN VI		502	8	4	1996-2001	F819620 - L674200	-	-	-	-	-	-	8	
8.9L	500 BULLDOG		540	8	4	1990-2001	C577254 - M050281	-	-	-	-	-	-	8	
8.9L	575		540	8	4	1986-1992	A677429 - D763716	-	7	-	-	18-3937	18-3939	18-3938	8

- (1) Cast Aluminum (Use with GM Engine Code 1XW)
- (2) Cast aluminum (Use with GM Engine Code 4XW)
- (3) Forged Aluminum (Use with GM Engine Code 3UB)
- (4) Cast Aluminum (Use with GM Engine Code 4XX)
- (5) Cast Aluminum (Use with GM Engine Code 2XY)
- (6) Cast Aluminum (Use with GM Engine Code 4XY)
- (7) Flat Head
- (8) Forged Aluminum, Recessed Head
- (9) Starboard
- (10) Port
- (11) .010 (25mm) Oversize

N.L.A. No longer available from O.E. source

N.L.A. No longer available from O.E. source

 <p><b>ROD BEARINGS</b></p> <table border="1" style="width: 100%; border-collapse: collapse;"> <thead> <tr> <th>Part #</th> <th>Size</th> <th>Replaces Mercuriser:</th> </tr> </thead> <tbody> <tr><td>18-1148</td><td>Std.</td><td>68704A1</td></tr> <tr><td>18-1308</td><td>Std.</td><td>23-85701</td></tr> <tr><td>18-1309</td><td>.010</td><td>23-85704</td></tr> <tr><td>18-1327</td><td>Std.</td><td>23-11992</td></tr> <tr><td>18-1329</td><td>Std.</td><td>23-85677</td></tr> <tr><td>18-1333</td><td>.010</td><td>23-85691</td></tr> <tr><td>18-1334</td><td>Std.</td><td>23-85726</td></tr> <tr><td>18-1337</td><td>.010</td><td>23-811858</td></tr> <tr><td>18-1341</td><td>.020</td><td>23-85705</td></tr> </tbody> </table>	Part #	Size	Replaces Mercuriser:	18-1148	Std.	68704A1	18-1308	Std.	23-85701	18-1309	.010	23-85704	18-1327	Std.	23-11992	18-1329	Std.	23-85677	18-1333	.010	23-85691	18-1334	Std.	23-85726	18-1337	.010	23-811858	18-1341	.020	23-85705	 <p><b>MAIN BEARINGS</b></p> <table border="1" style="width: 100%; border-collapse: collapse;"> <thead> <tr> <th>Part #</th> <th>Per Eng.</th> <th>Size</th> <th>Replaces Mercuriser:</th> <th>Part #</th> <th>Per Eng.</th> <th>Size</th> <th>Replaces Mercuriser:</th> </tr> </thead> <tbody> <tr> <td>18-1300</td> <td>①</td> <td>Std.</td> <td>23-818465</td> <td>18-1316</td> <td>①</td> <td>.010</td> <td>23-818471</td> </tr> <tr> <td>18-1311</td> <td>①</td> <td>Std.</td> <td>23-801793</td> <td>18-1317</td> <td>①</td> <td>Std.</td> <td>23-818469</td> </tr> <tr> <td>18-1315</td> <td>①</td> <td>Std.</td> <td>23-818473</td> <td></td> <td></td> <td></td> <td></td> </tr> </tbody> </table>	Part #	Per Eng.	Size	Replaces Mercuriser:	Part #	Per Eng.	Size	Replaces Mercuriser:	18-1300	①	Std.	23-818465	18-1316	①	.010	23-818471	18-1311	①	Std.	23-801793	18-1317	①	Std.	23-818469	18-1315	①	Std.	23-818473					 <p><b>CAM BEARINGS</b></p> <table border="1" style="width: 100%; border-collapse: collapse;"> <thead> <tr> <th>Part #</th> <th>Per Eng.</th> <th>Replaces Mercuriser:</th> </tr> </thead> <tbody> <tr> <td>18-1339</td> <td>1 ①</td> <td>23-43293</td> </tr> </tbody> </table>	Part #	Per Eng.	Replaces Mercuriser:	18-1339	1 ①	23-43293
Part #	Size	Replaces Mercuriser:																																																																				
18-1148	Std.	68704A1																																																																				
18-1308	Std.	23-85701																																																																				
18-1309	.010	23-85704																																																																				
18-1327	Std.	23-11992																																																																				
18-1329	Std.	23-85677																																																																				
18-1333	.010	23-85691																																																																				
18-1334	Std.	23-85726																																																																				
18-1337	.010	23-811858																																																																				
18-1341	.020	23-85705																																																																				
Part #	Per Eng.	Size	Replaces Mercuriser:	Part #	Per Eng.	Size	Replaces Mercuriser:																																																															
18-1300	①	Std.	23-818465	18-1316	①	.010	23-818471																																																															
18-1311	①	Std.	23-801793	18-1317	①	Std.	23-818469																																																															
18-1315	①	Std.	23-818473																																																																			
Part #	Per Eng.	Replaces Mercuriser:																																																																				
18-1339	1 ①	23-43293																																																																				
<p>① Complete engine set</p>																																																																						

HP	Liter	Model	Note	CID	# Cyl	Stroke	Year	Serial Number	ROD BEARING			MAIN BEARING			CAM BEARING
									Std.	0.01	0.02	Std.	0.01	0.02	
100		100 VASER		98	4	4	2007-2010	W995000 & UP	-	-	-	-	-	-	-
120		120		153	4	4	1964-1986	1666601 - B531853	18-1329	-	-	-	-	-	-
120	2.5L	120/2.5L		153	4	4	1987-1989	B531854 - C853255	18-1329	18-1330	-	18-1317	18-1316	-	18-1339
140		140		181	4	4	1968-1986	2508261 - B450800	18-1308	18-1309	18-1341	18-1317	18-1316	-	18-1331
140		140		181	4	4		3462608 - 5157668	18-1308	18-1309	18-1341	18-1317	18-1316	-	18-1339
140		140		181	4	4		5157669 - 6229717	18-1308	18-1309	18-1341	18-1317	18-1316	-	18-1339
140	3.0L	140 / 3.0L		181	4	4		6229718 & Up	18-1308	18-1309	18-1341	18-1317	18-1316	-	18-1339
	3.0L	3.0L		181	4	4	1987-1989	B450801 - C856558	18-1308	-	-	-	-	-	-
	3.0L	3.0L		181	4	4	1990-1994	C856559 - F603999	18-1308	18-1309	18-1341	18-1317	18-1316	-	18-1339
	3.0L	3.0L		181	4	4	1998-1999	L010042 - L605541	18-1308	-	-	-	-	-	-
	3.0L	3.0L		181	4	4	2000-2010	L605542 & UP	-	-	-	-	-	-	-
	3.0L	3.0L MPI		181	4	4	2008-2010	A07282 & UP	-	-	-	-	-	-	-
	3.0L	3.0LX		181	4	4	1990-1997	C856559 - K999999	18-1308	-	18-1341	-	-	-	-
		165		224	4	4	1987	B434941 - B774251	-	-	-	-	-	-	-
		170		224	4	4	1985-1986	6916779 - B434940	-	-	-	-	-	-	-
		180		224	4	4	1987	B436391 - B775248	-	-	-	-	-	-	-
		190		224	4	4	1985-1986	6916779 - B436390	-	-	-	-	-	-	-
	3.7L	3.7L		224	4	4	1988-1989	B774252 - C762299	-	-	-	-	-	-	-
	3.7L	3.7LX		224	4	4	1988-1989	B775249 - C762299	-	-	-	-	-	-	-
		470		224	4	4	1976-1984	4208730 - 6916778	-	-	-	-	-	-	-
		485		224	4	4	1980-1982	5685394 - 6218036	-	-	-	-	-	-	-
		488		224	4	4	1983-1984	6170297 - 6916778	-	-	-	-	-	-	-
		140		6	4			1538930 - 1725960	18-1329	18-1330	-	-	-	-	-
		150			4			1666495 - 2048046	18-1329	18-1330	-	-	-	-	-
		160		250	6	4	1967-1969	2048022 - 2770031	18-1329	18-1330	-	-	18-1320	-	-
		165		250	6	4	1970-1981	2770032 - 5813433	18-1329	18-1330	-	-	18-1320	-	-
	4.3L	175 / 4.3L		262	6	4		B527955 & Up	18-1327	18-1337	18-1338	18-1311	-	-	-
		185	4bbl	229	6	4	1983-1984	6330183 - 6919655	-	-	-	-	-	-	-
		175		262	6	4	1987	B527955 - B773242	-	-	-	-	-	-	-
		185	2bbl	262	6	4	1985-1986	A331455 - B527954	-	-	-	-	-	-	-
		205		262	6	4	1985-1986	A331455 - B527954	-	-	-	18-1300	-	-	-
	4.3L	262 MAG / 262 EFI / 262 GEN +		262	6	4	1996-1997	F803800 - K999999	-	-	-	-	-	-	-
	4.3L	4.3L GEN II		262	6	4	1992-1996	D714107 - F802999	18-1327	18-1337	18-1338	18-1311	-	-	-
	4.3L	4.3L GEN +		262	6	4	1998-2010	L010044 & UP	-	-	-	-	-	-	-
	4.3L	4.3L EFI / 4.3L GEN +		262	6	4	1998-2001	L012009 - M299999	-	-	-	-	-	-	-
	4.3L	4.3L MPI		262	6	4	2002-2010	M3000000 & UP	-	-	-	-	-	-	-
	4.3L	4.3LH GEN +		262	6	4	1998-2002	L010044 - M614999	-	-	-	-	-	-	-
	4.3L	4.3LX		262	6	4	1988-1991	B775130 - D714369	-	-	-	-	-	-	-
	4.3L	4.3LX GEN II		262	6	4	1992-1996	D714370 - F802999	-	-	-	-	-	-	-
	4.3L	4.3LX GEN +		262	6	4	1996-1997	F803000 - K999999	-	-	-	-	-	-	-
	4.3L	4.3LXH GEN +		262	6	4	1996-1997	F803114 - K999999	-	-	-	-	-	-	-
		185		262	6	4		A331455 & Up	18-1327	18-1337	18-1338	18-1311	-	-	-
		205		262	6	4		A331455 & Up	18-1327	18-1337	18-1338	18-1311	-	-	-
	4.3L	205 / 4.3L / 4.3LX LX		262	6	4		B527955 & Up	18-1327	18-1337	18-1338	18-1311	-	-	-
		4.3LX GEN II		262	6	4		D714370 & Up	18-1327	18-1337	18-1338	18-1311	-	-	-
		190	GM	283	8	4	1963-1964	1564539 - 1730903	18-1329	18-1330	-	-	-	-	-
		200						2453769 - 2712072	18-1308	18-1309	18-1341	18-1317	18-1316	-	-
		200	GM			4		6218462 & Up	18-1308	18-1309	18-1341	18-1300	-	-	-
	5.0L	500			8	4		B525982 & Up	18-1308	18-1309	18-1341	18-1300	-	-	-
	5.0L	215	FORD	302	8	4		2781153 - 3395720	18-1336	-	-	-	-	-	-
	5.0L	225	FORD	302	8	4	1973-1974	3385721 - 4166999	18-1329	18-1330	-	-	-	-	-
	5.0L	225 S	FORD	302	8	4	1973-1974	3385721 - 4166999	-	-	-	-	-	-	-
	5.0L	225	GM		8	4		1536920 - 2278646	18-1329	18-1330	-	-	-	-	-
	5.0L	225	GM		8	4		2278647 - 2399397	18-1329	18-1330	-	18-1317	18-1316	-	-
	5.0L	225	GM		8	4		2399398 & Up	18-1308	18-1309	18-1341	18-1300	-	-	-
	5.0L	225	GM		8	4		4765100 & Up	18-1308	18-1309	18-1341	18-1300	-	-	-
	5.0L	888		302	8	4	1971-1977	3108723 - 4887829	-	-	-	-	-	-	-
		190		283	8	4	1963-1964	1564539 - 1730903	18-1329	-	-	-	-	-	-
	5.0L	198 MIE		305	8	4	1977	4776402 - 4931099	18-1308	-	-	-	-	-	-
	5.0L	200		305	8	4	1985-1987	6899058 - B774444	18-1308	-	-	-	-	-	-
	5.0L	228		305	8	4	1977-1984	4765100 - 6899268	18-1308	-	-	-	-	-	-
	5.0L	228 MIE		305	8	4	1977-1980	4765100 - 5907057	18-1308	-	-	-	-	-	-
	5.0L	230		305	8	4	1985-1987	6899269 - B773739	18-1308	-	-	-	-	-	-
	5.0L	230	GM	305	8	4	1981-1987	5907058 - B788151	18-1308	18-1309	18-1341	18-1300	-	-	-
	5.0L	5.0L		305	8	4	1988-1995	B774445 - F600999	18-1308	-	-	-	-	-	-
	5.0L	5.0L GEN +		305	8	4	1998-2010	L015751 & UP	18-1308	-	-	-	-	-	-
	5.0L	5.0L EFI GEN +		305	8	4	1998-2001	L012052 - M299999	18-1308	-	-	-	-	-	-
	5.0L	5.0L MIE		305	8	4	1988	B788152 - C396832	18-1308	-	-	-	-	-	-
	5.0L	5.0L MPI		305	8	4	2002-2010	M3000000 & UP	18-1308	-	-	-	-	-	-
	5.0L	5.0LX		305	8	4	1988-1995	B773740 - F600999	18-1308	-	-	-	-	-	-
	5.0L	230 / 5.0L	GM	305	8	4		B522506 & Up	18-1308	18-1309	18-1341	18-1300	-	-	-
		230	GM		8	4		6218462 & Up	18-1308	18-1309	18-1341	18-1300	-	-	-
	5.0L	230 / 5.0L / 5.0LX	GM	305	8	4		B525982 & Up	18-1308	18-1309	18-1341	18-1300	-	-	-
	5.0L	898		305	8	4	1977-1984	4762210 - 6899057	18-1308	-	-	-	-	-	-
		225	GM	327	8	4	1963-1967	1539620 - 2399397	18-1329	-	-	-	-	-	-
		225	GM	327	8	4	1968-1969	2399398 - 2694014	18-1308	-	-	-	-	-	-

HP	Liter	Model	Note	CID	# Cyl	Stroke	Year	Serial Number	ROD BEARING			MAIN BEARING			CAM BEARING
									Std.	0.01	0.02	Std.	0.01	0.02	
		250		327	8	4	1968-1969	2314301 - 2639854	18-1308	18-1309	18-1341	18-1300	-	-	-
	5.7L	250		350	8	4	1977	4768000 - 4908849	18-1308	18-1309	18-1341	18-1300	-	-	-
	5.7L	255	GM	350	8	4	1975-1976	4175500 - 4767999	18-1308	18-1309	18-1341	18-1300	-	-	-
	5.7L	255 MIE		350	8	4	1975-1980	4175500 - 5907057	18-1308	-	-	-	-	-	-
	5.7L	260	GM	350	8	4	1978-1987	4908850 - B773304	18-1308	18-1309	18-1341	18-1300	-	-	-
	5.7L	260 MIE		350	8	4	1981-1987	5907058 - B788151	18-1308	18-1309	18-1341	-	-	-	-
	5.7L	260 / 5.7L	GM	350	8	4		B525982 & Up	18-1308	18-1309	18-1341	18-1300	-	-	-
	5.7L	260 / 5.7L	GM	350	8	4		B522506 & Up	18-1308	18-1309	18-1341	18-1300	-	-	-
	5.7L	270	GM	350	8	4	1969-1972	2851074 - 3077735	18-1308	18-1309	18-1341	18-1300	-	-	-
	5.7L	280	GM	350	8	4	1975-1976	4176250 - 4770199	18-1308	18-1309	18-1341	18-1300	-	-	-
	5.7L	300	GM	350	8	4	1985-1986	6668677 - B430367	18-1308	18-1309	18-1341	18-1300	-	-	-
	5.7L	320 EFI	GM	350	8	4	1987-1989	A543604 - C622418	18-1308	18-1309	18-1341	18-1300	-	-	-
	5.7L	320 EFI BRAVO	GM	350	8	4		B157603 & Up	18-1308	18-1309	18-1341	18-1300	-	-	-
		325 GM			8	4		2278747 & Up	18-1334	18-1333	18-1332	18-1315	-	-	-
		330 GM			8	4		4623115 & Up	18-1334	18-1333	18-1332	18-1315	-	-	-
		330 W.B.W.	GM		8	4		6083045 & Up	18-1334	18-1333	18-1332	18-1315	-	-	-
	7.4L	340 / 7.4L	GM		8	4		5889914 & Up	18-1334	18-1333	18-1332	18-1315	-	-	-
	5.7L	350 MAG ALPHA		350	8	4	1986-1997	A635178 - K999999	18-1308	18-1309	18-1341	18-1300	-	-	-
	5.7L	350	GM	350	8	4		3780450 & Up	18-1334	18-1333	18-1332	18-1315	-	-	-
	5.7L	350 MAG / 350 ALPHA / 350 EFI / 350 GEN +		350	8	4	1996-1997	F800300 - K999999	18-1308	-	-	-	-	-	-
	5.7L	350 MAG / 350 BRAVO / 350 MPI		350	8	4	1995	F415189 - F601999	18-1308	-	-	-	-	-	-
	5.7L	350 MAG / 350 BRAVO / 350MPI / 350 GEN +		350	8	4	1996-1997	F602000 - K999999	18-1308	-	-	-	-	-	-
	5.7L	350 MAG SKI		350	8	4	1994-1996	F215561 - F820706	18-1308	-	-	-	-	-	-
	5.7L	350 MAG EFI SKI GEN +		350	8	4	1996-1997	F820707 - K999999	18-1308	-	-	-	-	-	-
	5.7L	350 MAG MPI GEN +		350	8	4	1988-2010	L010019 & UP	18-1308	-	-	-	-	-	-
	5.7L	350 MAG MPI / 350 MAG MIE GEN +		350	8	4	1998-2007	L002008 - A089999	18-1308	-	-	-	-	-	-
	5.7L	350MG / 350 MPI / 350 SKI		350	8	4	1995-1996	F350583 - F799999	18-1308	-	-	-	-	-	-
	5.7L	350 MAG / 350 MPI / 350 SKI / 350 GEN +		350	8	4	1998-2007	L002600 - A089999	18-1308	-	-	-	-	-	-
	5.7L	350 MAG SKI		350	8	4	1991-1997	D505450 - K999999	18-1308	-	-	-	-	-	-
	5.7L	5.7L		350	8	4	1988-1997	4908850 - F600999	18-1308	-	-	-	-	-	-
	5.7L	5.7L GEN +		350	8	4	1998-2010	L010037 & UP	18-1308	-	-	-	-	-	-
	5.7L	5.7L EFI		350	8	4	1995-1997	F225560 - K999999	18-1308	-	-	-	-	-	-
	5.7L	5.7L EFI GEN +		350	8	4	1998-2001	L010035 - M2999999	18-1308	-	-	-	-	-	-
	5.7L	5.7L EFI MIE GEN +		350	8	8	1997	K040300 - K999999	18-1308	-	-	-	-	-	-
	5.7L	5.7L MIE		350	8	4	1988-1997	B788152 - K999999	18-1308	-	-	-	-	-	-
	5.7L	5.7L MIE GEN +		350	8	4	1998-2010	L002003 & UP	18-1308	-	-	-	-	-	-
	5.7L	5.7L MPI / 5.7L MIE		350	8	4	2008-2010	A090000 & UP	18-1308	-	-	-	-	-	-
	5.7L	5.7L MPI SKI		350	8	4	2008-2010	A090000 & UP	18-1308	-	-	-	-	-	-
	5.7L	5.7L SKI		350	8	4	1985-1987	A338553 - K999999	18-1308	-	-	-	-	-	-
	5.7L	5.7L SKI GEN +		350	8	4	1998-2010	L002005 & UP	18-1308	-	-	-	-	-	-
	5.7L	5.7LX		350	8	4	1996-1997	F601000 - F600999	18-1308	-	-	-	-	-	-
	5.7L	5.7LX / 5.7LX BRAVO / 5.7LX EFI / 5.7LX GEN +		350	8	4	1996-1997	F800300 - K999999	18-1308	-	-	-	-	-	-
	5.7L	5.7L EFI		350	8	4	1996-1997	F752400 - K999999	18-1308	-	-	-	-	-	-
	5.7L	BLACK SCORPION SKI GEN +		350	8	4	1996-2006	F800000 - W689999	18-1308	-	-	-	-	-	-
	5.7L	BLACK SCORPION SKI GEN +		350	8	4	2003-2007	W690000 - W698432	-	<b>1</b>	<b>1</b>	-	-	-	-
	5.7L	SCORPION 350		350	8	4	2008-2010	W698433 & UP	-	<b>1</b>	<b>1</b>	-	-	-	-
		233			351	8	4	1975-1974	4173000 - 4902304	-	-	-	-	-	-
		255	FORD	351	8	4	1973-1974	3258728 - 4175499	-	-	-	-	-	-	-
		TOURNEY SKI			8	4		D505450 & Up	18-1308	18-1309	18-1341	18-1300	-	-	-
		370 TRS	GM		8	4		6721528 & Up	18-1334	18-1333	18-1332	18-1315	-	-	-
		377 MAG		377	8	4	2008-2010	A3000000 & UP	-	<b>1</b>	<b>1</b>	-	-	-	-
		377 SCORPION MCM		377	8	4	1999-2005	L416145 - M907201	-	<b>1</b>	<b>1</b>	-	-	-	-
		377 SCORPION SKI GEN +		377	8	4	1997-1998	K000656 - L600314	-	<b>1</b>	<b>1</b>	-	-	-	-
	6.2L	MX 6.2L MPI		377	8	4	2000-2007	L680003 - A299999	-	<b>1</b>	<b>1</b>	-	-	-	-
	6.2L	MX 6.2L MPI / MX 6.2L HORIZON		377	8	4	2002-2007	M3000000 - A299999	-	<b>1</b>	<b>1</b>	-	-	-	-
	6.2L	MX 6.2L MPI / MX 6.2L HORIZON / MX 6.2L MIE		377	8	4	2002-2010	M3000000 & UP	-	<b>1</b>	<b>1</b>	-	-	-	-
	6.2L	MX 6.2L MPI / MX 6.2L MIE		377	8	4	2002-2010	M3000000 & UP	-	<b>1</b>	<b>1</b>	-	-	-	-
	6.2L	MX 6.2L BLACK SCORPION SKI		377	8	4	2002-2007	M3000000 - W698432	-	<b>1</b>	<b>1</b>	-	-	-	-
	6.2L	SCORPION 377		377	8	4	2008-2010	W698433 & UP	-	<b>1</b>	<b>1</b>	-	-	-	-
	7.4L	325		454	8	4	1969-1972	2278747 - 3780449	-	-	-	-	-	-	-
	7.4L	330		454	8	4	1977-1987	4623115 - B816540	-	-	-	-	-	-	-
	7.4L	330 MIE		454	8	4	1977-1980	4623115 - 5889913	-	-	-	-	-	-	-
	7.4L	340 MIE W/B-W		454	8	4	1981-1987	5889914 - B788365	-	-	-	-	-	-	-
	7.4L	350 MIE		454	8	4	1974-1976	3780450 - 4623109	-	-	-	-	-	-	-
	7.4L	370 TRS		454	8	4	1978-1987	4179554 - B714586	-	-	-	-	-	-	-
		390	GM		8	4		2781129 - 2825059	18-1334	18-1333	18-1332	18-1315	-	-	-
	7.4L	400 TRS		454	8	4	1980-1986	4179554 - B457644	-	-	-	-	-	-	-
	7.4L	420	GM	454	8	4	1987-1989	A398941 - B622418	18-1334	18-1333	18-1332	18-1315	-	-	-
	7.4L	425	GM	454	8	4	1990-1992	B622419 - D725499	-	-	-	18-1315	-	-	-
	7.4L	425 GEN V		454	8	4	1992-1993	D725500 - D937011	-	-	-	-	-	-	-
	7.4L	440 TRS		454	8	4	1983-1986	4179554 - B485220	-	-	-	-	-	-	-
	7.4L	450 GEN V		454	8	4	1995-1996	F347100 - F347277	-	-	-	-	-	-	-
	7.4L	454 MAG ALPHA	GM	454	8	4	1986-1988	A631894 - B785148	18-1334	18-1333	18-1332	18-1315	-	-	-
	7.4L	454 MAG BRAVO		454	8	4	1988-1992	B721206 - D805068	-	-	-	-	-	-	-
	7.4L	454 MAG BRAVO	GM	454	8	4		B840126 & UP	18-1334	18-1333	18-1332	18-1315	-	-	-

**1** 8 PAIR BEARING SET

HP	Liter	Model	Note	CID	# Cyl	Stroke	Year	Serial Number	ROD BEARING			MAIN BEARING			
									Std.	0.01	0.02	Std.	0.01	0.02	CAM BEARING
7.4L	454	MAG BRAVO GEN V		454	8	4	1992-1996	D805069 - M801699	18-1334	18-1333	18-1332	18-1315	-	-	-
7.4L	454	MAG BRAVO GEN VI		454	8	4	1996-1997	F801700 - K999999	-	-	-	-	-	-	-
7.4L	454	MAG EFI GEN V		454	8	4	1994-1996	F115700 - F802349	-	-	-	-	-	-	-
7.4L	454	MAG EFI SKI GEN V		454	8	4	1995-1996	F215800 - F820099	-	-	-	-	-	-	-
7.4L	454	MAG MPI GEN VI		454	8	4	1996-2001	F802350 - M024999	-	-	-	-	-	-	-
7.4L	454	MAG MPI / 454 MAG HORIZON / 454 MAG MIE		454	8	4	1998-2001	L002200 - L674000	-	-	-	-	-	-	-
7.4L	454	MAG MPI / 454 MAG SKI GEN VI		454	8	4	1996-1997	F820100 - K999999	-	-	-	-	-	-	-
7.4L	454	EFI		454	8	4		F115700 & UP	18-1334	18-1333	18-1332	18-1315	-	-	-
	502	MAG	GM		8	4		C878221 & Up	18-1334	18-1333	18-1332	18-1315	-	-	-
	502	MAG BRAVO GEN V			8	4		D824589 & Up	18-1334	18-1333	18-1332	18-1315	-	-	-
	502	MAG BRAVO GEN V			8	4		D840650 & Up	18-1334	18-1333	18-1332	18-1315	-	-	-
	502	EFI			8	4		3108723 & Up	18-1336	-	-	-	-	-	-
	525	SC		454	8	4	1991-1992	D456000 - D725808	-	-	-	-	-	-	-
	525	SC GEN V		454	8	4	1992-1996	D763746 - F745215	-	-	-	-	-	-	-
	525	SC GEN V		454	8	4	1996-1999	F745260 - L415623	-	-	-	-	-	-	-
7.4L	7.4L	BRAVO		454	8	4	1988-1991	B771113 - D603117	-	-	-	-	-	-	-
7.4L	7.4L	BRAVO GEN V		454	8	4	1992-1996	D603118 - F800699	-	-	-	-	-	-	-
7.4L	7.4L	BRAVO GEN VI		454	8	4	1996-1997	F800700 - K299999	-	-	-	-	-	-	-
7.4L	7.4L	EFI / 7.4L MIE GEN VI		454	8	4	1996-1997	F874815 - K999999	-	-	-	-	-	-	-
7.4L	7.4L	MIE		454	8	4	1988-1992	B788366 - D715493	-	-	-	-	-	-	-
7.4L	7.4L	MIE GEN V		454	8	4	1992-1996	D715494 - F820141	-	-	-	-	-	-	-
7.4L	7.4L	LH / 7.4L MIE GEN VI		454	8	4	1996-1997	F820142 - K999999	-	-	-	-	-	-	-
7.4L	7.4L	MPI GEN V		454	8	4	1998-2001	L010003 - M024330	-	-	-	-	-	-	-
7.4L	7.4L	MPI GEN V / 7.4L MIE GEN V		454	8	4	1995-1996	F563052 - F820103	-	-	-	-	-	-	-
7.4L	7.4L	MPI GEN VI / 7.4L MIE GEN VI		454	8	4	1996-1997	F820104 - K999999	-	-	-	-	-	-	-
7.4L	7.4L	MPI GEN VI L29 / 7.4L MIE GEN VI L29		454	8	4	1998-2001	L002006 - M025999	-	-	-	-	-	-	-
7.4L	7.4L	X BRAVO TBI GEN VI		454	8	4	1988-2001	F802000 - K999999	-	-	-	-	-	-	-
7.4L	7.4L	X BRAVO MPI GEN V		454	8	4	1996	F602010 - F801999	-	-	-	-	-	-	-
7.4L	7.4L	X BRAVO MPI GEN VI		454	8	4	1996-1997	F802000 - K999999	-	-	-	-	-	-	-
7.4L	7.4L	BRAVO	GM					D603118 & Up	18-1334	18-1333	18-1332	18-1315	-	-	-
7.4L	7.4L	BRAVO GEN V						C391564 & Up	18-1334	18-1333	18-1332	18-1315	-	-	-
7.4L	7.4L	W/HURTH						D715494 & Up	18-1334	18-1333	18-1332	18-1315	-	-	-
7.4L	7.4L	HURTH						C878221 & Up	18-1334	18-1333	18-1332	18-1315	-	-	-
	390			482	8	4	1969-1970	2781129 - 2825059	-	-	-	-	-	-	-
	460	TRS		482	8	4	1983-1986	4179554 - 6181046	-	1	1	-	-	-	-
	496	MAG / 496 HO		496	8	4	2001-2010	M025000 & UP	-	-	-	-	-	-	-
	8.1S	MPI / 8.1S MIE / 8.1S HO		496	8	4	2001-2010	M025000 & UP	-	-	-	-	-	-	-
8.2L	465			502	8	4	1990-1992	C849992 - D725646	-	-	-	-	-	-	-
8.2L	465	GEN V		502	8	4	1992-1994	D725647 - F213244	-	-	-	-	-	-	-
8.2L	500	GEN V		502	8	4	1994-1996	F213293 - F745159	-	-	-	-	-	-	-
8.2L	500	GEN VI		502	8	4	1997-1999	K745195 - L601036	-	-	-	-	-	-	-
8.2L	500	EFI		502	8	4	1999-2000	L001477 - L306499	-	-	-	-	-	-	-
8.2L	500	EFI		502	8	4	2000-2005	L306500 - M907127	-	-	-	-	-	-	-
8.2L	502	MAG BRAVO		502	8	4	1990-1992	C876221 - D824588	-	-	-	-	-	-	-
8.2L	502	MAG BRAVO GEN V		502	8	4	1992-1993	D824589 - F114528	-	-	-	-	-	-	-
8.2L	502	MAG EFI		502	8	4	1993-1996	D840650 - F802599	-	-	-	-	-	-	-
8.2L	502	MAG MPI GEN VI		502	8	4	1996-2001	F802600 - M024999	-	-	-	-	-	-	-
8.2L	525	EFI		502	8	4	2003-2007	M900146 - M958499	-	-	-	-	-	-	-
8.2L	525	EFI		502	8	4	2007-2010	M958500 & UP	-	-	-	-	-	-	-
8.2L	575	SCi		502	8	4	20071-2005	L306696 - M950526	-	-	-	-	-	-	-
8.2L	600	SC		502	8	4	1991-1992	D456489 - D456768	-	-	-	-	-	-	-
8.2L	600	SC GEN V		502	8	4	1992-1996	D725676 - F877642	-	-	-	-	-	-	-
8.2L	600	SC GEN VI		502	8	4	1997-2000	K000227 - L601186	-	-	-	-	-	-	-
8.2L	8.2L	MAG		502	8	4	2010	A350340 & UP	-	-	-	-	-	-	-
8.2L	8.2L	MIE		502	8	4	2010	A350802 & UP	-	-	-	-	-	-	-
8.2L	8.2L	MIE W/HURTH		502	8	4	1990-1992	C878221 - D857199	-	-	-	-	-	-	-
8.2L	8.2L	W/HURTH (IB)		502	8	4		D857200 & Up	18-1334	18-1333	18-1332	18-1315	-	-	-
8.2L	8.2L	MIE GEN V		502	8	4		D857200 - F819619	-	-	-	-	-	-	-
8.2L	8.2L	MPI GEN VI / 8.2L MIE GEN VI / 8.2LH GEN VI		502	8	4	1996-2001	F819620 - L674200	-	-	-	-	-	-	-
	500	BULLDOG		540	8	4	1990-1996	C577254 - F745405	-	1	1	-	-	-	-
	500	BULLDOG		540	8	4	1997-2001	K000248 - M050281	-	1	1	-	-	-	-
	575			540	8	4	1986-1992	A677429 - D763716	-	1	1	-	-	-	-
	800	SC GEN V		540	8	4	1993-1998	D763836 & UP	-	1	-	-	-	-	-
	888		FORD		8	4		4762210 & Up	18-1308	18-1309	18-1341	18-1300	-	-	-
	898 / 198		GM					A338553 & Up	18-1308	18-1309	18-1341	18-1300	-	-	-

1 8 PAIR BEARING SET

MERCURISER 3.7L BEARING APPLICATION

Model	Serial Number	ROD BEARINGS			MAIN BEARINGS			MAIN (THRUST BEARINGS)		
		Std.	.010	.020	Std.	.010	.020	Std.	.010	.020
165\3.7 (4cyl)	6916779 & Up	18-1148	-	-	-	18-1131	-	18-1149	-	-
170 (4cyl)	6916779 & Up	18-1148	-	-	-	18-1131	-	18-1149	-	-
180\3.7L (4cyl)	6916779 & Up	18-1148	-	-	-	18-1131	-	18-1149	-	-
190 (4cyl)	6916779 & Up	18-1148	-	-	-	18-1131	-	18-1149	-	-
470	4208730 & Up	18-1148	-	-	-	18-1131	-	18-1149	-	-
485	5685394 & Up	18-1148	-	-	-	18-1131	-	18-1149	-	-
488	6170297 & Up	18-1148	-	-	-	18-1131	-	18-1149	-	-

 <p><b>18-0518</b> <b>VALVE STEM SEAL</b> Replaces: 26-34217</p>	 <p><b>18-4023</b> <b>VALVE STEM SEAL</b> Replaces: 26-75413 For: 165, 170, 180, 190 4 cyl. (224 CID) SN 6916779 &amp; later</p>	 <p><b>18-4022</b> <b>VALVE STEM SEAL</b> Replaces: 26-75988 For: 330 (SN 4623115 &amp; later), 340 (1B) (SN 5889914 &amp; later), 454 Mag (SN A631894 &amp; later)</p>	<p>PKG. OF 8</p>  <p><b>18-4024</b> <b>18-4024-9<sup>②</sup></b> <b>VALVE STEM SEAL</b> Replaces: 26-97664</p>
 <p><b>One Piece Rear Main Seals</b></p> <p><b>18-1234</b> Replaces: 26-811554 For: 7.4L, GL, GI, GSI: 8.2L, GL</p> <p><b>18-0519</b> Replaces: 26-14240 4.3L/3.0L/5.0L 5.7L</p> <p><b>18-0864</b> Replaces: 26-90925</p>	 <p><b>Two Piece Rear Main Seals</b></p> <p><b>18-0528</b> Replaces: 26-56868</p> <p><b>18-1211</b> Replaces: 26-58203</p>	 <p><b>Timing Cover Seals</b></p> <p><b>18-1213</b> Replaces: 26-79223, 26-97335, 26-59341</p> <p><b>18-1233</b> Replaces: 26-8219471</p> <p><b>18-0578</b> Replaces: 26-67388</p>	

**MERCURUISER SEAL APPLICATION**

Model	Serial No.	Rear Main Crankshaft Seal	Timing Cover Seal
120/2.5L	1666601 & UP	—	18-1213
120/2.5L	2786857 & UP	18-1211	18-1213
140/3.0L & LX	2508261 & UP	—	18-1213
140/3.0L & LX	6229718 & UP	18-1211	18-1213
150/160/165/200 (I/L-6)	1666495 & UP	—	18-1213
150/160/165/200 (I/L-6)	2770032 & UP	18-1211	18-1213
175/185/205/262/4.3L (V-6)	6330183 & UP	18-1211	18-1213
200/228/225/230/250/255/260/270			
280/300/320/5.0L/5.7L/898(V-8)	2453769 & UP	18-1211 <sup>①</sup>	18-1213
215	2781153 & UP	18-0528	—
224I/L4	ALL	18-0864	18-0578
225 FORD	3885721 & UP	18-0528	—
5.0L/5.7L, 4.3L, 3.0L Std. Rotation	"All" one piece seal	18-0519	18-1213
340 (7.4L)	4623115 & UP	—	18-1233
370 TRS	5889914 & UP	—	18-1233
400 TRS	4179554 & UP	—	18-1233
420	A398941 & UP	—	18-1233
440 TRS	4179554 & UP	—	18-1233
454 MAGNUM	A631894 & UP	—	18-1233
460 TRS	4179554 & UP	—	18-1233
7.4L/8.2L/454/502 Std. Rotation	"All" one piece seal	18-1234	18-1233
7.4 BRAVO	B771113 & UP	—	18-1233
888 (188)	3108723 & UP	18-0528	—

① Lrg. Journal Crankshaft GM Engines

② Priced per Package



MANIFOLD & EXHAUST MANIFOLD GASKET SETS



**18-0403**  
**INTAKE GASKET KIT**  
 Replaces: 27-805722A1  
 For: MCM 370, 400, 325, 454, 502 Mag, 7.4L Bravo II & MIE 8.2L1978-1997



**18-0404**  
**INTAKE GASKET KIT**  
 Replaces: 27-805403A1  
 For: MCM/MIE 454 Mag MPI, 7.4L/LX MPI & 8.2L MPI 1993-UP



**18-0603**  
**EXHAUST MANIFOLD GASKET SET**  
 For: Ford 302/351 CID Engines  
 For use with 18-1998-1

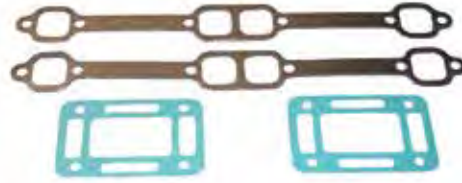

**18-0604**  
**EXHAUST MANIFOLD GASKET SET**  
 For: GM 305/350 CID Engines  
 For use with 18-1997-1



**18-4347-1**  
**EXHAUST MANIFOLD GASKET SET**  
 For: GM 175, 185, 205 (229 & 262 CID)

— CONTAINS —

Part #	Description	O.E. #	Qty.
18-0897	Exhaust Elbow Mounting Gasket	27-41813-1	2
18-2909	Exhaust Manifold to Cyl. Head Gasket	27-99757	2



**18-4348**  
**EXHAUST MANIFOLD GASKET SET**  
 For: GM 454, 525 (7.4L & 8.2L)

— CONTAINS —

Part #	Description	O.E. #	Qty.
18-0418	Manifold to Cylinder Head Gasket	27-46820	2
18-0897	Exhaust Elbow Mounting Gasket	27-41813-1	2

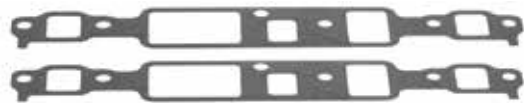

**18-4408**  
**INTAKE MANIFOLD GASKET SET**  
 Replaces: 27-11977  
 For: GM 262 CID Engines 175, 185 and 205 HP

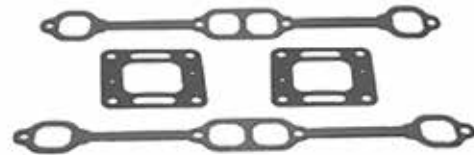

**18-4349**  
**EXHAUST MANIFOLD GASKET SET**  
 For: GM 200, 228, 230, 260, 898 (5.0 & 5.7L)

— CONTAINS —

Part #	Description	O.E. #	Qty.
18-0872	Exhaust Manifold Gasket	27-33395	2
18-0897	Exhaust Elbow Mounting Gasket	27-41813-1	2



**18-4367**  
**EXHAUST MANIFOLD GASKET SET**  
 Replaces: 27-99777A1  
 For: GM 153 & 181 (2.5 & 3.0L) CID Eng's; 120 & 140 HP S/N 6229718 & UP  
 (With Siamese Port Cylinder Heads)

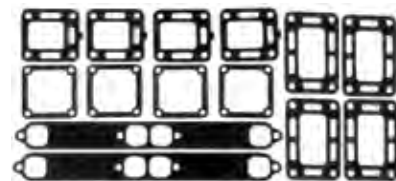

**18-4394**  
**EXHAUST MANIFOLD GASKET SET**  
 Replaces: 27-33395A2  
 For: GM 350 (5.7L) CID Eng; 250 HP S/N 4768000-4908849 255 HP S/N 5195909 & UP

— CONTAINS —

Part #	Description	O.E. #	Qty.
18-2832	Manifold End Cap Gasket	27-48043	4
18-2833	Exhaust Elbow Gasket	27-99777-2	4
18-0872	Exhaust Manifold Gasket	27-33395	2
18-0885	Exhaust Elbow Gasket	27-48042	4



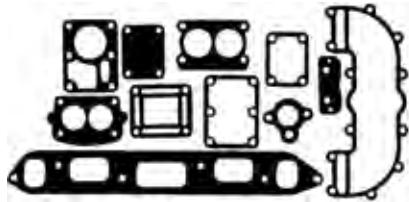

**18-4395**  
**EXHAUST MANIFOLD GASKET SET**  
 Replaces: 27-35898A-4  
 For: GM 153 (2.5L) CID Eng;  
 120 HP S/N 2046625-6229717

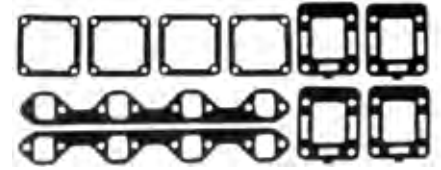

**18-4399**  
**EXHAUST MANIFOLD GASKET SET**  
 Replaces: 27-54566A1  
 For: Ford 302/351 (5.0L & 5.8L) CID Eng; All 888 (188 HP)  
 & 233 HP, 255 HP S/N 3258728-4175498  
 — CONTAINS —

Part #	Description	O.E. #	Qty.
18-0183	Exhaust Mounting Gasket	27-46820	2
18-2832	Manifold End Cap Gasket	27-48043-1	4
18-2833	Exhaust Elbow to Gasket	27-99777-2	4



**18-4397**  
**EXHAUST MANIFOLD GASKET SET**  
 Replaces: 27-46820A1  
 For: GM 454 (7.4L) CID Eng; All 325, 350, 400 HP Jet Drives 330 HP S/N 6083144 & BELOW  
 — CONTAINS —

Part #	Description	O.E. #	Qty.
18-0418	Exhaust Mounting Gasket	27-46820	2
18-0885	Exhaust Elbow Mounting Gasket	27-48042	4
18-2832	Manifold End Cap Gasket	27-48043-1	4

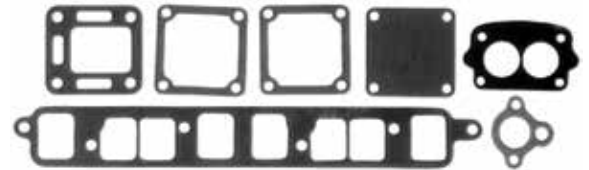

**18-4398**  
**EXHAUST MANIFOLD GASKET SET**  
 Replaces: 27-53354A1  
 For: GM 181 (3.0L) CID Eng; 140 HP S/N 3332137-6229717  
 (Without Siamese Port Cylinder)

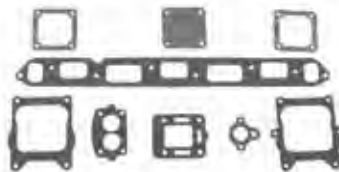

**18-4396**  
**EXHAUST MANIFOLD GASKET SET**  
 Replaces: 27-46401A1  
 For: 250 (4.1L) CID Eng; 165 HP S/N 2770032 & UP  
 — CONTAINS —

Part #	Description	O.E. #	Qty.
18-2830	Intake Exhaust Gasket	27-46401	1
18-2831	Thermostat Gasket	27-47590-1	1
18-2832	Manifold End Cap Gasket	27-48083-1	2
18-2833	Exhaust Elbow Gasket	27-99777-2	1
18-0353	Carb. Mounting Gasket	27-58764	1
18-0356	Carb. Mounting Gasket	27-64692	1
18-0928	Exhaust End Cap Gasket	27-73814	1



**18-4376**  
**TIMING CHAIN GASKET SET**  
 Replaces: 27-34895A2  
 For: GM 305 & 350 CID Engs. 200, 225,  
 228, 230, 250, 255, 260, 270, 280 HP 898  
 (198 HP) & 5.7L (SKI)  
 — CONTAINS —

Part #	Description	O.E. #	Qty.
18-0976	Seal Retainer Cover Gasket	27-14250	1
18-0889	Fuel Pump Mounting Gasket	27-34213	1
18-0891	Water Pump Mounting Gasket	27-34897	2
18-0876	Fuel Pump Mounting Gasket	27-34898	1
18-0893	Water Pump Back. Plate Gasket	27-35380	1
18-0185	Oil Filter & Adapter Seal	27-91892	1
18-0331	Vent Adapter Screw Gasket	27-35593	1

**CYLINDER HEAD AND INTAKE MANIFOLD GASKET SETS**

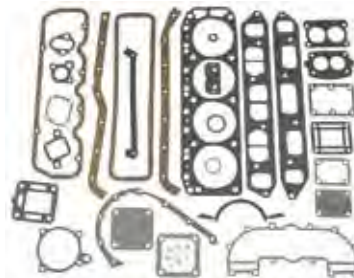

**18-4383**  
 For: GM 153 (2.5L) CID Eng;  
 S/N 2324347 & UP Includes 18-3880 Head Gasket

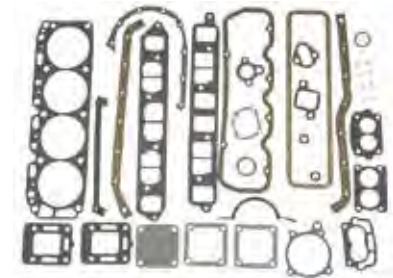

**18-4384**  
 For: GM 181 (3.0L) CID Eng;  
 S/N 2508261-6229717 (Except 3.0LX)

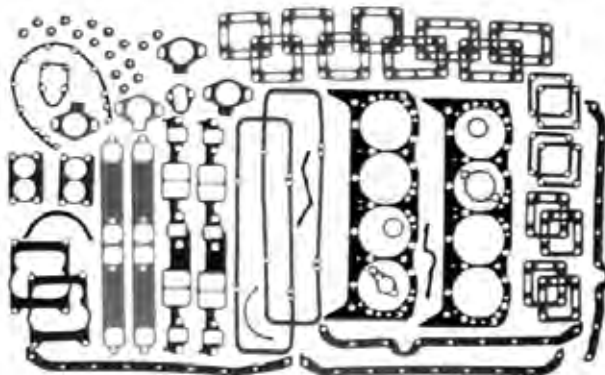

**18-4386**  
 For: GM 305 & 350 (5.0L & 5.7L) CID Eng; With Heads (1987 & Earlier)

— CONTAINS —

Part #	Description	O.E. #	Qty.
18-0976	Timing Chain Cover Gasket	27-14250	1
18-0868	Intake Manifold Gasket	27-17145	1
18-0872	Exhaust Manifold Gasket	27-33395	2
18-0897	Exhaust Elbow Mounting Gasket	27-41813	2
18-0885	Exhaust Elbow Mounting Gasket	27-48042	4
18-2917	Lower Thermostat Housing Gasket	27-53045-1	1
18-0153	Port Dip Gasket	27-85817A1	1
18-2848	Quadrajel Base Gasket	27-58457-2	2
18-2849	Exhaust Elbow To Manifold Gasket	27-87105-1, 27-818832	4
18-3876	Head Gasket	27-75611	2
18-2554	Thermostat Gasket	27-41812	1
18-2832	Manifold End Cap Gasket	27-48043-1	4
18-2553	Thermostat Gasket	27-47510	1
18-2833	Exhaust Elbow To Manifold Gasket	27-99777-2	4
18-2844	Thermostat Cover Gasket	27-48818-1	1
18-0889	Fuel Pump Housing Gasket	27-34213	1
18-0891	Water Pump Mounting Gasket	27-34897	1
18-0905	Oil Pan Drain Plug Gasket	27-49955	1
18-0876	Water Pump Mounting Gasket	27-34898	1
18-0994	Carb. Mounting Gasket	27-70143-1	2
18-0518	Seal	26-34217	16
18-2845	Valve Cover Gasket	121-122	2

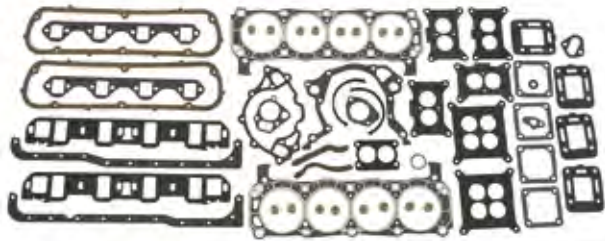

**18-4385**  
 For: Ford 302 (5.0L) CID Eng; 215, 225 & 888 (188 HP)  
 Includes 18-3883 Head Gasket

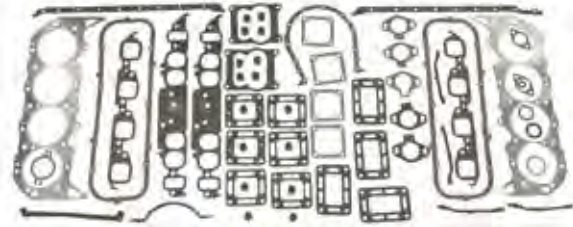

**18-4387**  
 Replaces: 27-801853  
 For: GM 454 (7.4L) CID Eng; Production Models  
 Oval Port  
 Includes 18-3877 Head Gasket



**18-0465**  
**INTAKE MANIFOLD GASKET SET**  
 Replaces: 27-65184  
 For: GM 454 CID Engines, 325, 330, 340, 350 HP  
 and 454 Magnums, 7.4L

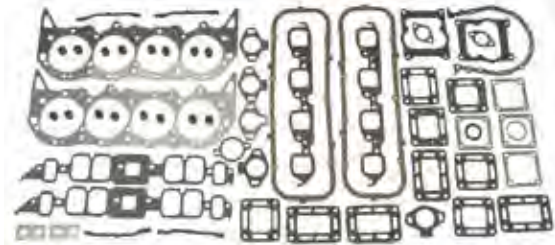

**18-4365**  
**EXHAUST MANIFOLD GASKET SET**  
 Replaces: 27-801855  
 For: GM 454 (7.4L) CID Eng; Production Models  
 Rectangular Port  
 Includes 18-3877 Head Gasket



**18-4388**  
**INTAKE MANIFOLD GASKET SET**  
 Replaces: 27-11977A88, A92  
 For: GM 262 CID Eng; 175, 185 & 205 HP, 4.3L  
 Includes 18-3879 Head Gasket

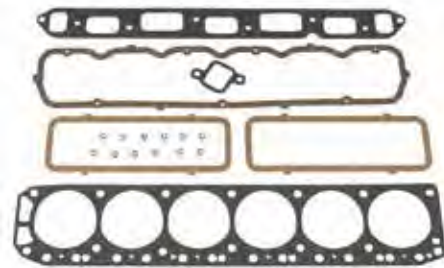

**18-4389**  
**INTAKE MANIFOLD GASKET SET**  
 Replaces: 27-47453A1  
 For: All GM 165 HP (S/N 270032 & UP) & Inline 6 cyl.  
 250 CID

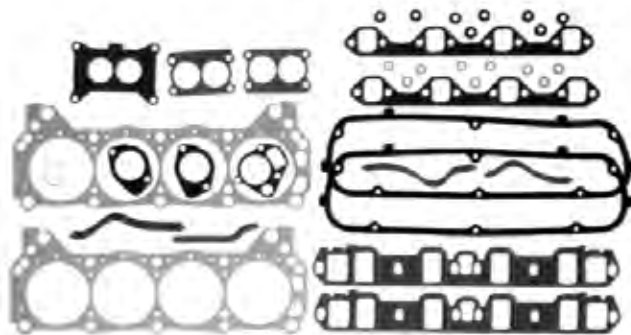

**18-4391**  
**INTAKE MANIFOLD GASKET SET**  
 Replaces: 27-64763A2  
 For: Ford 351 CID Eng; 233 HP S/N 4173000-4500860, 5.8L  
 Includes 18-3883 Head Gasket

**18-4392**  
**INTAKE MANIFOLD GASKET SET**  
 Replaces: 27-75611A2  
 For: GM 305 & 350 CID Eng, 898 (198 HP) 200, 228,  
 230/260 (Inboard) 230, 250, 255, 260, 280 & 5.7L Ski

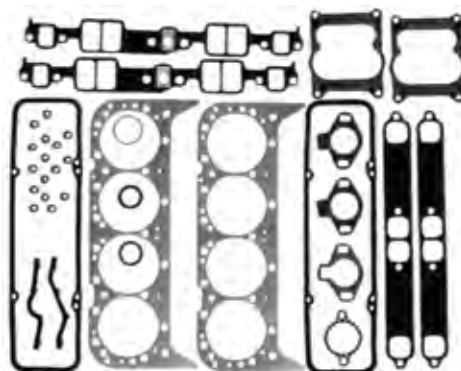

— CONTAINS —

Part #	Description	O.E. #	Qty.
18-0868	Intake Manifold Gasket	27-17145	1
18-0872	Exhaust Manifold Gasket	27-33395	2
18-2848	Quadrajel Base Gasket	27-52457-2	2
18-3876	Head Gasket	27-75611	2
18-2553	Thermostat Gasket	27-47510	1
18-2844	Thermostat Cover Gasket	27-48818-1	1
18-2554	Thermostat Gasket	27-41812	2
18-2917	Lower Thermostat Housing Gasket	27-53045-1	1
18-2845	Valve Cover Gasket	27-11999	2
18-0518	Seal	26-34217	16

**OVERHAUL GASKET SETS**

(Sets do not include Front and Rear Crankshaft Seals)

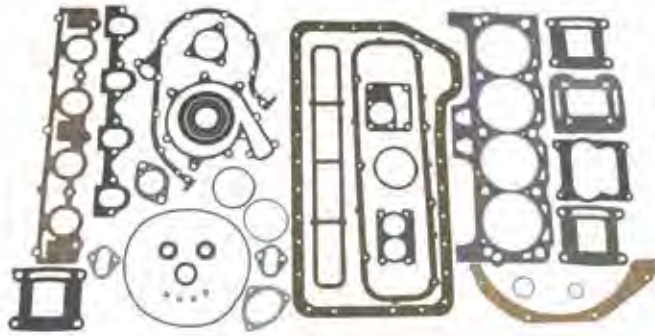

**18-4381**

Replaces: 27-43186A1

For: 224 (3.7L) CID Eng; 165, 170, 180, 190 HP  
S/N 6916779 & UP

— CONTAINS —

Part #	Description	O.E. #	Qty.
18-0175	O-Ring	25-26543	4
18-0860	O-Ring	25-62700	1
18-0864	Seal	26-90925	1
18-0881	Exhaust Elbow Mounting Gasket	27-18272	1
18-0992	Exhaust Manifold Mounting Gasket	27-68715	1
18-0994	Carburetor Mounting Gasket	27-70143-1	1
18-0158	Intake Manifold Gasket	27-70905	1
18-0111	Exhaust Elbow Mounting Gasket	27-89657	2
18-0160	Lower Exhaust to Intake Manifold Gasket	27-94136	1
18-0113	Exhaust Elbow Mounting Gasket	27-97542	1
18-2843	Thermostat Cover Gasket	27-74830	1
18-2848	QuadraJet Base Gasket	27-52457-2	1
18-3878	Head Gasket	27-13709T	1
18-7121	O-Ring	25-35027	1
18-0874	Distributor Gasket	27-34486	1
18-0185	Seal	27-91892	1
18-2555	Thermostat Gasket	27-89656-1	1
18-0889	Fuel Pump Mounting Gasket	27-34213	1
18-4366	Oil Pan Gasket Set	27-72479A5	1
18-0387	Flywheel Cover Gasket	27-94976	1
18-0172	Oil Seal	26-97530	2

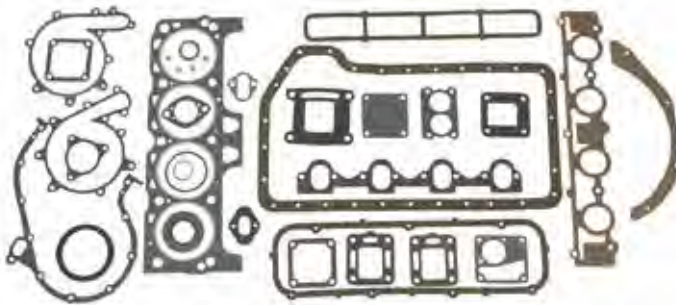

**18-4382**

Replaces: 27-74830A3

For: 224 (3.7L) CID Eng; 470 S/N 4208730 & UP

— CONTAINS —

Part #	Description	O.E. #	Qty.
18-0864	Seal	26-90925	1
18-0992	Exhaust Manifold Mounting Gasket	27-68715	1
18-0158	Intake Manifold Gasket	27-70905	1
18-0950	Impeller Cover Gasket	27-88046	1
18-0954	Exhaust Mounting Gasket	27-92720	1
18-0113	Exhaust Elbow Mounting Gasket	27-97542	1
18-2832	Manifold End Cap Gasket	27-48043-1	2
18-2833	Exhaust Elbow To Manifold Gasket	27-99777-2	2
18-2843	Thermostat Cover Gasket	27-74830	1
18-3878	Head Gasket	27-13709T	1
18-0175	O-Ring	25-26543	4
18-0889	Fuel Pump Mounting Gasket	27-34213	1
18-7121	O-Ring	25-35029	1
18-0874	Distributor Gasket	27-34486-3	1
18-0928	Manifold End Cap Gasket	27-73814	1
18-0994	Carb. Mounting Gasket	27-70143-1	1
18-2555	Thermostat Cover Gasket	27-89656-1	1
18-4366	Oil Pan Gasket Set	27-72479A5	1
18-0387	Flywheel Cover Gasket	27-94976	1

**MISCELLANEOUS GASKET SETS**

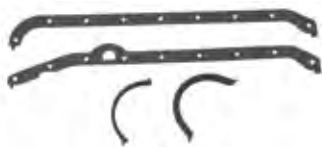

**18-0153**

**OIL PAN GASKET SET**

Replaces: 27-85817A1

For: Mercruiser GM 350 CID (5.7L)



**18-0340**

**OIL PAN GASKET SET**

Replaces: 27-49949

For: Mercruiser 160/165 (6 cyl.)



**18-1239**

**OIL PAN GASKET**

Replaces: 27-810846T

For: Mercruiser 3.0L GM 181



**18-0348**

**OIL PAN GASKET SET**

Replaces: 27-52550

For: Mercruiser GM 454/502 CID Eng; (7.4L and 8.2L)



**18-1237**

**OIL PAN GASKET**

Replaces: 27-138651



**18-0466**

**OIL PAN GASKET SET**

Replaces: 27-14901A1

For: Mercruiser GM 153/181 (2.5L & 3.0L)



**18-1238**

**INTAKE GASKET SET**

Replaces: 24-824326

For: Mercruiser 4.3L/LX models, pre SN F802999



**18-1231**

**INTAKE GASKET**

Replaces: 27-818188-1

For: Rectangular port high performance big block Chevy



**18-0405**

**OIL PAN GASKET**

Replaces:

27-14247-1, 27-883964

For: Mercruiser GM 262 CID Eng. (4.3L)



**18-0407**  
**OIL PAN GASKET SET**  
 Replaces: 27-64798  
 For: Mercruiser: 215, 225, 888



**18-0410**  
**INTAKE MANIFOLD GASKET SET**  
 Replaces: 27-75648  
 For: Ford 5.0L/302, 5.8L/351 CID Engine; (233HP)  
 S/N 3108723 & UP



**18-0411**  
**OIL PAN GASKET SET**  
 Replaces: 27-90458A1  
 For: Mercruiser GM 350 CID (5.7L)  
 Starboard Dipstick



**18-0611**  
**OIL PAN GASKET SET**  
 Replaces: 27-75483  
 For: Mercruiser Ford 351 CID Eng.

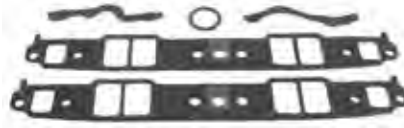

**18-0868**  
**INTAKE MANIFOLD GASKET SET**  
 Replaces: 27-17145  
 For: Mercruiser 305, 350

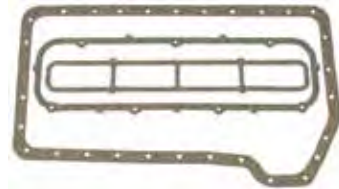

**18-4366**  
**OIL PAN GASKET SET**  
 Replaces: 27-72479A5  
 For: Mercruiser 224 CID (3.7L)

**18-4375**  
**TIMING CHAIN GASKET SET**  
 Replaces: 27-34213A2  
 For: Mercruiser GM 153 & 181 CID Eng's: 110, 120, 130, 140, 150, 160 & 165 HP; 2.5L & 3.0L



— CONTAINS —

Part #	Description	O.E. #	Qty.
18-0889	Fuel Pump Mounting Gasket	27-34213	1
18-0887	Timing Cover Gasket	27-49953	1
18-0948	Distributor Gasket	27-87707	1
18-0327	Water Pump Gasket	27-33956	1



**18-4377**  
**TIMING CHAIN GASKET SET**  
 Replaces: 27-42457A1  
 For: GM 262 CID Eng: 175, 185 & 205 HP

**18-4378**  
**TIMING CHAIN GASKET SET**  
 Replaces: 27-54529A1  
 For: GM 454 CID Eng. 325, 330, 340 & 350 Inboards & 300TRS



— CONTAINS —

Part #	Description	O.E. #	Qty.
18-0889	Fuel Pump Mounting Gasket	27-34213	1
18-0903	Water Pump Gasket	27-49110	2
18-0980	Timing Chain Gasket	27-54529	1



**18-4380**  
**TIMING CHAIN GASKET SET**  
 Replaces: 27-68714A6  
 For: Mercruiser 224 CID Eng.  
 165, 170, 180, 190, 470, 485 & 488 HP

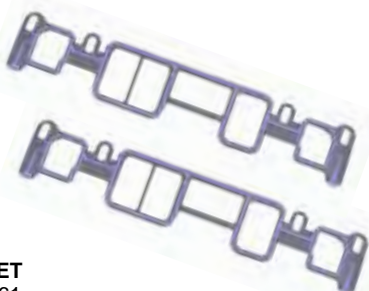

**18-0487**  
**INTAKE GASKET SET**  
 Replaces: 27-8243261  
 Fits: MCM 262 Mag & 4.3L/LX/LH/LXH Gen II (1996-up)

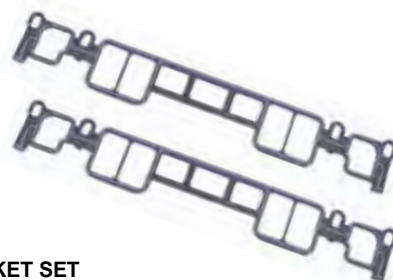

**18-0488**  
**INTAKE GASKET SET**  
 Replaces: 27-807473A1  
 Fits: MCM 350 Mag, 5.0L & 5.7L/LX Gen II (1996-up)



**18-2946**  
**HEAD GASKET**  
 Replaces: 27-52364, 27-81084  
 For: GM 181 (3.0L) CID Eng.



**18-3874**  
**HEAD GASKET**  
 Replaces: 27-811546  
 For: (8.2L) 502 CID



**18-3876**  
**HEAD GASKET**  
 Replaces: 27-75611  
 For: GM 305 (5.0L)/350 (5.7L) CID Eng.



**18-3877**  
**HEAD GASKET**  
 Replaces: 27-13687  
 For: GM 454 (7.4L) CID Eng.



**18-3878**  
**HEAD GASKET**  
 Replaces: 27-13709T  
 For: Mercruiser 224 (3.7L) CID Eng. Model 470



**18-3879**  
**HEAD GASKET**  
 Replaces: 27-11986, 27-816460  
 For: GM 262 (4.3L) CID Eng.



**18-3880**  
**HEAD GASKET**  
 Replaces: 27-34273, 27-810841  
 For: GM 153 (2.5L), (3.0L) CID Eng.



**18-3881**  
**HEAD GASKET**  
 Replaces: 27-47453  
 For: GM 250 (4.1L) CID (6 cyl) Eng.



**18-3883**  
**HEAD GASKET**  
 Replaces: 27-75647  
 For: Ford 302 (5.0L) 351 (5.8L) CID Eng.



**18-3887**  
**HEAD GASKET**  
 Replaces: 27-850470  
 For: (7.4L) 454 CID GEN V and IV (1992-up)



**18-0353**  
**CARB MOUNTING GASKET**  
 Replaces: 27-58764



**18-0354**  
**CARB MOUNTING GASKET**  
 Replaces: 27-60715



**18-0685**  
**VALVE COVER GASKET**  
 Replaces: 27-73666  
 224 CID (3.7L)



**18-0356**  
**CARB MOUNTING GASKET**  
 (For Rochester)  
 Replaces: 27-64692



**18-0357**  
**CARB MOUNTING GASKET**  
 Replaces: 27-65577

PKG. OF 2



**18-0876**  
**18-0876-9①**  
**FUEL PUMP GASKET**  
 For GM 4.3L, 5.0L & 5.7L  
 Replaces: 27-34898

PKG. OF 2



**18-0889**  
**18-0889-9①**  
**FUEL PUMP GASKET**  
 For GM 4.3L, 5.0L & 5.7L  
 Replaces: 27-34213

SEE PAGES 166-167 FOR OUR COMPLETE LINE OF GASKET SEALANTS

① Priced per Package



**18-0360**  
**CARB MOUNTING GASKET**  
 Replaces: 27-70142



**18-0462**  
**CARB MOUNTING GASKET**  
 Replaces: 27-48399

Model	Year	S/N
250	1968-69	2314301-2639854
270	1969-72	2851074-3385720
325	1969-70	2278747-3042730
390	1969-70	2781129-3042731



**18-0463**  
**CARB MOUNTING GASKET**  
 (For Weber)  
 Replaces: 27-814210



**18-0467**  
**CARB MOUNTING GASKET**  
 (For Weber)  
 Replaces: 27-41610

PKG OF 2



**18-0994**  
**18-0994-9<sup>①</sup>**  
**CARB MOUNTING GASKET**  
 Replaces: 27-70143-1

PKG OF 2



**18-2848**  
**18-2848-9<sup>①</sup>**  
**CARB BASE GASKET**  
 Replaces: 27-524572

PKG. OF 2



**18-0874**  
**18-0874-9<sup>①</sup>**  
**DISTRIBUTOR GASKET**  
 For GM V6 & V8  
 Replaces: 27-344863  
 For: 2.6L (1989), 3.5L (1989), 4.3L (1987-93), 5.0L (1987-88), 5.7L (1987-92), 7.4L (1988-93), 8.2L (1992-93)

PKG OF 2



**18-0948**  
**18-0948-9<sup>①</sup>**  
**DISTRIBUTOR GASKET**  
 Replaces: 27-87707  
 4 Cyl.



**18-0349**  
**THERMOSTAT GASKET**  
 Replaces: 27-54506  
 For: Ford V-8

PKG. OF 2



**18-2552**  
**18-2552-9<sup>①</sup>**  
**THERMOSTAT GASKET**  
 Replaces: 27-331792

PKG. OF 2



**18-0667**  
**18-0667-9<sup>①</sup>**  
**CONNECTOR COVER GASKET**  
 Replaces: 27-995061

PKG. OF 2



**18-2553**  
**18-2553-9<sup>①</sup>**  
**THERMOSTAT GASKET**  
 Replaces: 27-47510  
 GM V-6, V-8

PKG. OF 2



**18-2554**  
**18-2554-9<sup>①</sup>**  
**THERMOSTAT GASKET**  
 Replaces: 27-41812,  
 27-90556  
 V-6 & V-8

PKG. OF 2



**18-2555**  
**18-2555-9<sup>①</sup>**  
**THERMOSTAT GASKET**  
 Replaces: 27-896561  
 4 Cyl.

PKG OF 2



**18-2831**  
**18-2831-9<sup>①</sup>**  
**THERMOSTAT GASKET**  
 Replaces: 27-475901  
 4 & 6 Cyl.

PKG OF 2



**18-2834**  
**18-2834-9<sup>①</sup>**  
**THERMOSTAT GASKET**  
 Replaces: 27-60208  
 Ford V-8

PKG OF 2



**18-2843**  
**18-2843-9<sup>①</sup>**  
**THERMOSTAT GASKET**  
 Replaces: 27-74830  
 470

PKG OF 2



**18-2844**  
**18-2844-9<sup>①</sup>**  
**THERMOSTAT GASKET**  
 Replaces: 27-488181  
 V-8

PKG OF 2



**18-2917**  
**18-2917-9<sup>①</sup>**  
**THERMOSTAT GASKET**  
 Replaces: 27-530451

PKG OF 2



**18-0398**  
**18-0398-9<sup>①</sup>**  
**THERMOSTAT GASKET**  
 Replaces: 27-530451

SEE PAGES 166-167 FOR OUR COMPLETE LINE OF GASKET SEALANTS

<sup>①</sup> Priced per Package

 <p><b>18-0111</b> <b>EXHAUST ELBOW GASKET</b> Replaces: 27-89657</p>	 <p><b>18-0113</b> <b>EXHAUST ELBOW GASKET</b> Replaces: 27-97542, 27-856705</p>	<p>PKG OF 2</p>  <p><b>18-0672</b> <b>18-0672-9①</b> <b>EXHAUST ELBOW GASKET</b> Replaces: 27-860231, 8637251</p>	 <p><b>18-0365</b> <b>HEAT EXCHANGER END GASKET</b> Replaces: 27-75450 224 CID</p>
 <p><b>18-0389</b> <b>HEAT EXCHANGER END GASKET</b> Replaces: 27-99960</p>	 <p><b>18-0881</b> <b>EXHAUST ELBOW GASKET</b> Replaces: 27-18272</p>	<p>PKG. OF 2</p>  <p><b>18-0885</b> <b>18-0885-9①</b> <b>EXHAUST ELBOW GASKET</b> Replaces: 27-48042</p>	 <p><b>18-0897</b> <b>EXHAUST ELBOW GASKET</b> Replaces: 27-41813</p>
<p>PKG. OF 2</p>  <p><b>18-0928</b> <b>18-0928-9①</b> <b>MANIFOLD END CAP GASKET</b> Replaces: 27-73814</p>	 <p><b>18-0954</b> <b>EXHAUST ELBOW GASKET</b> Replaces: 27-92720</p>	<p>PKG OF 2</p>  <p><b>18-2819</b> <b>18-2819-9①</b> <b>EXHAUST ELBOW GASKET</b> Replaces: 27-39915</p>	<p>PKG OF 2</p>  <p><b>18-2832</b> <b>18-2832-9①</b> <b>MANIFOLD END CAP GASKET</b> Replaces: 27-480431</p>
<p>PKG OF 2</p>  <p><b>18-2833</b> <b>18-2833-9①</b> <b>EXHAUST ELBOW GASKET</b> Replaces: 27-997772</p>	<p>PKG OF 2</p>  <p><b>18-2849</b> <b>18-2849-9①</b> <b>EXHAUST ELBOW GASKET</b> Replaces: 27-87105-1, 27-818832, 27-863726</p>	 <p><b>18-0158</b> <b>INTAKE MANIFOLD GASKET</b> Replaces: 27-70905 For: 3.7L</p>	 <p><b>18-0183</b> <b>EXHAUST MANIFOLD GASKET</b> Replaces: 27-73866</p>
 <p><b>18-0418</b> <b>EXHAUST MANIFOLD GASKET</b> Replaces: 27-46820</p>	<p>PKG. OF 2</p>  <p><b>18-2830</b> <b>EXHAUST MANIFOLD GASKET</b> Inline 6 cyl. Replaces: 27-46401</p>	 <p><b>18-0680</b> <b>EXHAUST MANIFOLD GASKET</b> Replaces: 27-815528</p>	 <p><b>18-2896</b> <b>EXHAUST MANIFOLD GASKET</b> Replaces: 27-52546</p>

SEE PAGES 166-167 FOR OUR COMPLETE LINE OF GASKET SEALANTS

① Priced per Package

PKG. OF 2



**18-2909**  
**18-2909-9①**  
**EXHAUST MANIFOLD GASKET**  
 Replaces: 27-99757



**18-0872**  
**EXHAUST MANIFOLD GASKET**  
 Replaces: 27-33395  
 GM 5.0L & 5.7L



**18-2912**  
**EXHAUST MANIFOLD GASKET**  
 Replaces: 27-53354



**18-0956**  
**EXHAUST MANIFOLD GASKET**  
 Replaces: 27-68715

PKG. OF 2



**18-1204**  
**18-1204-9①**  
**EXHAUST MANIFOLD GASKET**  
 Replaces: 27-96429



**18-0664**  
**VALVE COVER GASKET**  
 Replaces: 27-17467  
 For: GM 305/350, 5.0 & 5.7L



**18-2845**  
**VALVE COVER GASKET**  
 Replaces: 27-11999  
 V-8 GM 305/350 CID, 5.0 & 5.7L



**18-25001**  
**VALVE COVER GASKET**  
 Replaces: 27-14765  
 Fits: GM 454, 7.4L



**18-25002**  
**VALVE COVER GASKET**  
 Replaces: 27-811588  
 Fits: GM 454, 502, (1992-UP)  
 Recessed Grooved Valve Cover



**18-0311**  
**VALVE COVER GASKET**  
 Replaces: 27-11988  
 For: 4.3 Litre  
 262 CID



**18-0346**  
**VALVE COVER GASKET**  
 Replaces: 27-49936  
 For: GM 250 CID (4.1L), 160/165/200 (6 cyl.)



**18-0347**  
**VALVE COVER GASKET**  
 Replaces: 27-52145  
 For: GM 153 & 181 CID (2.5L & 3.0L)



**18-0352**  
**VALVE COVER GASKET**  
 Replaces: 27-56173  
 For: Ford 302/351 CID (5.0L & 5.8L)

PKG. OF 2



**18-0464**  
**18-0464-9①**  
**VALVE COVER GASKET**  
 Replaces: 27-49121  
 For: GM 454/502 CID (7.4L & 8.2L)

Model	Year	S/N
330	1977-81	4623115-6083144
7.4 Bravo	1988-91	B771113-D603117
454 Mag	1986-92	A631894-D805068
370 TRS	1978-87	4179554-B714586
400 TRS	1980-86	4179554-B457644
400 TRS	1983-86	4179554-B485220
460 TRS	1983-86	4179554-6181046
502 Mag Bravo	1990-92	C878221-D824588



**18-0468**  
**TIMING COVER GASKET**  
 Replaces: 27-811572  
 GM 4.3L, 5.0L & 5.7L

PKG. OF 2



**18-0887**  
**18-0887-9①**  
**TIMING COVER GASKET**  
 Replaces: 27-49953  
 4 & 6 Cyl.

PKG. OF 2



**18-0976**  
**18-0976-9①**  
**TIMING CHAIN COVER GASKET**  
 Replaces: 27-14250



**18-0980**  
**TIMING COVER GASKET**  
 Replaces: 27-54529  
 GM 7.4L

PKG. OF 2

















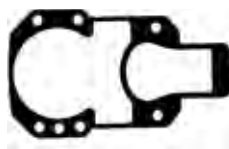



**18-0328**  
**18-0328-9①**  
**PUSH ROD/LIFTER COVER GASKET**  
 Replaces: 27-34208  
 153 & 181 CID, 120/140 (4 Cyl.)

SEE PAGES 166-167 FOR OUR COMPLETE LINE OF GASKET SEALANTS

① Priced per Package



 <p><b>18-0329 PUSH ROD/LIFTER COVER GASKET</b> Replaces: 27-34209 For: 140/150/160/165 (6 cyl.)</p>	 <p><b>18-2815 PUSH ROD COVER GASKET</b> Replaces: 27-814703 For: 3.0L</p>	<p>PKG. OF 2</p>  <p><b>18-1210 18-1210-9① END CAP GASKET</b> Replaces: 27-39923</p>	<p>PKG. OF 2</p>  <p><b>18-0185 18-0185-9① REMOTE OIL SEAL</b> Replaces: 27-91892</p>
 <p><b>18-1240 OUTDRIVE SEAL For Bravo</b> Replaces: 12708</p>	<p>PKG OF 5</p>  <p><b>18-2516 18-2516-9① BRAVO OUTDRIVE SEAL</b> Replaces: 16755</p>	<p>PKG. OF 2</p>  <p><b>18-2556 18-2556-9① DRIVE SHAFT HOUSING TO BELL HOUSING GASKET</b> Replaces: 27-35996, A1</p>	 <p><b>18-2743 OUTDRIVE HOUSING GASKET</b> Replaces: 27-94996-2, Q2</p>
<p>PKG OF 5</p>  <p><b>18-2820 18-2820-9① OUTDRIVE GASKET</b> Replaces: 27-64818, Q4</p>	<p>PKG OF 5</p>  <p><b>18-2840 18-2840-9① BELL HOUSING GASKET</b> Replaces: 27-35982</p>	<p>PKG OF 2</p>  <p><b>18-2847 18-2847-9① OUTDRIVE GASKET</b> Replaces: 27-54014 For: E, H, TR, TRS</p>	 <p><b>18-0386 WATER PUMP BODY GASKET</b> Replaces: 27-94914</p>
<p>PKG. OF 2</p>  <p><b>18-0894 18-0894-9① WATER POCKET COVER GASKET</b> Replaces: 27-55810, 27-55810 -1</p>	 <p><b>18-0916 WATER PUMP GASKET</b> Replaces: 27-8052151</p>	<p>PKG. OF 2</p>  <p><b>18-0903 WATER PUMP GASKET</b> Replaces: 27-49110 454 CID</p>	 <p><b>18-0147 WATER PUMP GASKET For Ford V-8</b> Replaces: 27-56880</p>
 <p><b>18-0327 WATER PUMP GASKET</b> Replaces: 27-33956 4 &amp; 6 Cyl.</p>	<p>PKG. OF 2</p>  <p><b>18-0891 18-0891-9① WATER PUMP MOUNTING GASKET</b> Replaces: 27-34897 For: GM 4.3L, 5.0L &amp; 5.8L</p>	<p>PKG. OF 2</p>  <p><b>18-0893 18-0893-9① WATER PUMP BACK-IN PLATE GASKET</b> Replaces: 27-35380 GM 4.3L, 5.0L &amp; 5.7L</p>	<p>PKG OF 2</p>  <p><b>18-2564 18-2564-9① IMPELLER GASKET Alpha I - Generation 2</b> Replaces: 27-430331</p>

SEE PAGES 166-167 FOR OUR COMPLETE LINE OF GASKET SEALANTS

① Priced per Package

 <p><b>18-0950</b> <b>IMPELLER HOUSING GASKET</b> Replaces: 27-88046 224 CID</p>	<p>PKG OF 2</p>  <p><b>18-2565</b> <b>18-2565-9①</b> <b>IMPELLER GASKET</b> Alpha I - Generation 2 Replaces: 27-430472</p>	<p>PKG OF 2</p>  <p><b>18-2566</b> <b>18-2566-9①</b> <b>IMPELLER GASKET</b> Alpha I - Generation 2 Replaces: 27-817277</p>	<p>PKG OF 2</p>  <p><b>18-2823</b> <b>18-2823-9①</b> <b>LOWER WATER PUMP GASKET</b> Replaces: 27-32769, 27-19553</p>
<p>PKG OF 2</p>  <p><b>18-2824</b> <b>18-2824-9①</b> <b>UPPER WATER PUMP GASKET</b> Replaces: 27-32770, 27-19551</p>	<p>PKG OF 2</p>  <p><b>18-2825</b> <b>18-2825-9①</b> <b>WATER PUMP BASE GASKET</b> Replaces: 27-32771</p>	<p>PKG OF 2</p>  <p><b>18-2826</b> <b>18-2826-9①</b> <b>WATER PUMP BASE GASKET</b> Replaces: 27-85610-1, 27-85670-4</p>	<p>PKG OF 2</p>  <p><b>18-2914</b> <b>18-2914-9①</b> <b>WATER PUMP GASKET</b> Replaces: 27-856081</p>
<p>PKG OF 2</p>  <p><b>18-2915</b> <b>18-2915-9①</b> <b>WATER PUMP GASKET</b> Replaces: 27-856091, 27-858524</p>	<p>PKG OF 2</p>  <p><b>18-2919</b> <b>18-2919-9①</b> <b>WATER PUMP GASKET</b> Replaces: 27-426311</p>	<p>PKG OF 2</p>  <p><b>18-0342</b> <b>POWER TRIM HOSE CONNECTOR PLATE GASKET</b> Replaces: 27-476441</p>	<p>PKG OF 2</p>  <p><b>18-0388</b> <b>POWER TRIM HOSE CONNECTOR GASKET</b> Replaces: 27-988231</p>
<p>PKG. OF 2</p>  <p><b>18-0322</b> <b>18-0322-9①</b> <b>REAR SEAL GASKET</b> Replaces: 27-14247, 27-881715 GM 5.0L &amp; 5.7L</p>	<p>PKG OF 2</p>  <p><b>18-3289</b> <b>DOUBLE LIP SEAL</b> Replaces: 26-864319 For: Gen II Upper Housing</p>	<p>PKG OF 2</p>  <p><b>18-2094</b> <b>OIL SEAL</b> Replaces: 26-88416 Fits: 120/140(1978-82), 165 (1978-81), 260 (1978-82), 470 (1978-82), 485 (1980-82), 898/228 (1978-82), Alpha I/Gen II (1991 &amp; Up), Blackhawk (1994-95), Bravo I/II/III (1988-98), R/MR/Alpha One Sterndrive and Transom (1983-90)</p>	<p>PKG OF 2</p>  <p><b>18-2944</b> <b>18-2944-9①</b> <b>SEAL RING GASKET (Quad Ring)</b> Replaces: 26-45577</p>
<p>PKG OF 2</p>  <p><b>18-2945</b> <b>18-2945-9①</b> <b>18-29451-9①</b> (PKG OF 50) <b>DRAIN SCREW GASKET</b> Replaces: 12-20260, 12-19183, 12-191832 Used in most lower units and sea water pumps</p>	<p>PKG OF 5</p>  <p><b>18-2948</b> <b>18-2948-9①</b> <b>RUBBER WASHER</b> Replaces: 12-49221-1, 12-49221</p>	<p>PKG OF 2</p>  <p><b>18-2349</b> <b>SHIFT SHAFT SLEEVE</b> Replaces: 23-67370 For: Ratios 1.47, 1.62, 1.81 &amp; 1.94. For: Gen II (1998 &amp; up), (0L100040 &amp; up) 1/4" Thick</p>	<p>PKG. OF 2</p>  <p><b>18-0905</b> <b>OIL PAN DRAIN PLUG GASKET</b> Replaces: 27-49955</p>

SEE PAGES 166-167 FOR OUR COMPLETE LINE OF GASKET SEALANTS

① Priced per Package

<p>PKG. OF 2</p>  <p><b>18-4267</b> <b>18-4267-9①</b> <b>SHIFT SHAFT WASHER</b> Replaces: 12-29395</p>	<p>PKG. OF 3</p>  <p><b>18-0681</b> <b>18-0681-9①</b> <b>WASHER</b> Replaces: 12-32834</p>	<p>PKG. OF 5</p>  <p><b>18-0203</b> <b>18-0203-9①</b> <b>BELL HOUSING WASHER</b> Replaces: 12-35935 All Mercruiser Stern drives 1963-1998</p>	<p>PKG. OF 5</p>  <p><b>18-2316</b> <b>18-2316-9①</b> <b>SHIFT SHAFT WASHER</b> Replaces: 12-77674 Used over 18-2349 sleeve For: Ratios 1.47, 1.62, 1.81 &amp; 1.94. For: Gen II (1998 &amp; up), (0L100040 &amp; up) 1/8" Thick</p>																		
 <p><b>18-0318</b> <b>WASHER</b> Replaces: 12-815472</p>	<p>PKG OF 2</p>  <p><b>18-4270</b> <b>18-4270-9①</b> <b>WASHER</b> Replaces: 12-36001</p>	<p>PKG OF 5</p>  <p><b>18-2340</b> <b>18-2340-9①</b> <b>SHIFT SHAFT WASHER</b> Replaces: 12-31266 For: #1R/MR (1/16" Thick)</p>	<p>PKG OF 2</p>  <p><b>18-2343</b> <b>18-2343-9①</b> <b>PINION NUT WASHER</b> Replaces: 12-92721 For: MR/Alpha/Gen II</p>																		
 <p style="text-align: center;"><b>SCREWS</b></p> <table border="1" data-bbox="771 1050 1201 1249"> <thead> <tr> <th>Part #</th> <th>Description</th> <th>O.E. #</th> </tr> </thead> <tbody> <tr> <td><b>18-2361</b></td> <td>(PKG. OF 2)</td> <td></td> </tr> <tr> <td><b>18-2361-9①</b></td> <td>Lower Unit Mounting Screw</td> <td>10-30206</td> </tr> <tr> <td><b>18-3197</b></td> <td>Water Pick-Up Insert Screw</td> <td>10-76156</td> </tr> <tr> <td><b>18-3230</b></td> <td>Gear Housing To Drive Shaft Housing Screw</td> <td>10-816601</td> </tr> <tr> <td><b>18-3231</b></td> <td>Upper Drive Shaft Top Cover Screw</td> <td>10-98794</td> </tr> </tbody> </table>			Part #	Description	O.E. #	<b>18-2361</b>	(PKG. OF 2)		<b>18-2361-9①</b>	Lower Unit Mounting Screw	10-30206	<b>18-3197</b>	Water Pick-Up Insert Screw	10-76156	<b>18-3230</b>	Gear Housing To Drive Shaft Housing Screw	10-816601	<b>18-3231</b>	Upper Drive Shaft Top Cover Screw	10-98794	<p>PKG OF 5</p>  <p><b>18-3721</b> <b>18-3721-9①</b> <b>NUT</b> Replaces: 11-13439-1, 11-859116 For: MR/Alpha</p>
Part #	Description	O.E. #																			
<b>18-2361</b>	(PKG. OF 2)																				
<b>18-2361-9①</b>	Lower Unit Mounting Screw	10-30206																			
<b>18-3197</b>	Water Pick-Up Insert Screw	10-76156																			
<b>18-3230</b>	Gear Housing To Drive Shaft Housing Screw	10-816601																			
<b>18-3231</b>	Upper Drive Shaft Top Cover Screw	10-98794																			
 <p><b>18-3236</b> <b>HOUSING ALIGNMENT BUSHING</b> Replaces: 23-32632 For: #1R/MR/Alpha</p>	 <p><b>18-4272</b> <b>WELCH PLUG</b> Replaces: 19-32652</p>	 <p><b>18-4273</b> <b>WELCH PLUG</b> Replaces: 19-42682</p>	 <p><b>18-2140</b> <b>ENGINE MOUNT BOLT KIT</b> For: Mercruiser I</p>																		
 <p><b>18-2141</b> <b>ENGINE MOUNT BOLT KIT</b> Replaces: 10-97934A1 For: R/MR/Alpha I/ Gen II/Bravo</p>	 <p><b>18-3728</b> <b>LOCK NUT</b> Replaces: 11-99298, 11-863332</p>	 <p><b>18-3729</b> <b>MOTOR MOUNT BOLT</b> Replaces: 10-97934</p>	 <p><b>18-2193</b> <b>REAR ENGINE MOUNT</b> Replaces: 99297A1 For 120/140 HP S/N 6229717 &amp; UP; All 224 CID Blocks; All 898, 200, 228, 230, 260, 300 &amp; 320 HP; All 350-454 Magnums</p>																		

① Priced per Package



**18-2614**  
**OUTDRIVE GASKET SET**  
**1967-1982**  
 Replaces: 27-64818A1, 27-64818T4, 27-64818Q4

—CONTAINS—

Part #	Description	O.E. #	Qty.
18-2820	Drive Shaft Housing to Bell Housing Gasket	27-64818	1
18-2840	Bell Housing Gasket	27-35982	1
18-7153	O-Ring	25-25439	2
18-7170	O-Ring	25-33504	1



**18-2615**  
**OUTDRIVE GASKET SET**  
**(Bravo Unit)**  
 Replaces: 16755A1, 16755Q1, 16755T1  
 For: All Bravo

—CONTAINS—

Part #	Description	O.E. #	Qty.
18-2516	Seal	16755	1
18-7198	O-Ring	25-45710	1
18-7153	O-Ring	25-25439	2
18-7168	O-Ring	25-48171	2
18-7105	O-Ring	25-62705	1
18-7117	O-Ring	25-35027	1

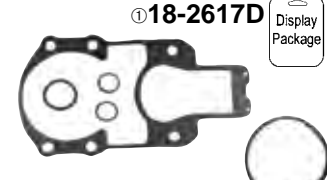

**18-2617**  
**OUTDRIVE GASKET SET**  
**Old Style**  
 Replaces: 27-35996A1  
 For: IA/IB/IC and EZ Shift (1964-1966)

—CONTAINS—

Part #	Description	O.E. #
18-2556	Drive Shaft Housing to Bell Housing Gasket	27-35996
18-2840	Bell Housing Gasket	27-35982
18-7153	O-Ring	25-25439
18-7170	O-Ring	25-33504

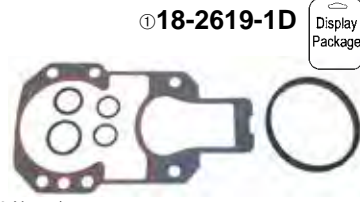

**18-2619-1**  
**OUTDRIVE GASKET SET**  
 Replaces: 27-64818A3, 27-94996Q2, 27-94996T2  
 For: R, MR, Alpha I, Alpha Gen II (1983-Newer)

—CONTAINS—

Part #	Description	O.E. #
18-2743	Drive Shaft Housing to Bell Housing Gasket	27-94996-2
18-2840	Bell Housing Gasket	27-35982
18-7153	O-Ring	25-25439
18-7170	O-Ring	25-33504
18-7117	O-Ring	25-35027



**18-2620**  
**OUTDRIVE GASKET SET**  
 Replaces: 27-54014A1, Q1  
 For: E, H, TR, TRS

—CONTAINS—

Part #	Description	O.E. No.
18-7175	O-Ring	25-62817
18-2847	Drive Shaft Housing to Bell Housing Gasket	27-54014

① Items ending in "D" are Display Packaged - Regular number is Non-Display

Stern Drive Model	Beginning Serial No.	Ending Serial No.	Bell Housing Gasket	Bell Housing O-Ring	Bell Housing Rubber Gasket	U-Joint O-Ring (2 Required)	Gasket Set
I	1534570	1684187	—	18-7170	—	18-7153	—
IA	1684188	2062140	18-2556	18-7170	18-2840	18-7153	18-2617
IB	1684633	2062140	18-2556	18-7170	18-2840	18-7153	18-2617
IC	1685240	2065189	18-2556	18-7170	18-2840	18-7153	18-2617
II TR	3377316	4794899	18-2847	18-7175	—	—	18-2620
120	2062141	6225576	18-2820	18-7170	18-2840	18-7153	18-2614
120	6225577	UP	18-2743	18-7170	18-2840	18-7153	18-2619-1
120	6225577	UP	18-2743 ③	18-7170	18-2840	18-7153	18-2619-1
140	2062141	6225576	18-2820	18-7170	18-2840	18-7153	18-2614
140	6225577	UP	18-2743	18-7170	18-2840	18-7153	18-2619-1
140	6225577	UP	18-2743 ③	18-7170	18-2840	18-7153	18-2619-1
160	2065190	2763441	18-2820	18-7170	18-2840	18-7153	18-2614
165	2763442	UP	18-2820	18-7170	18-2840	18-7153	18-2614
170	6225577	UP	18-2743	18-7170	18-2840	18-7153	18-2619-1
170	6225577	UP	18-2743 ③	18-7170	18-2840	18-7153	18-2619-1
185	6225577	UP	18-2743	18-7170	18-2840	18-7153	18-2619-1
185	6225577	UP	18-2743 ③	18-7170	18-2840	18-7153	18-2619-1
190	6225577	UP	18-2743	18-7170	18-2840	18-7153	18-2619-1
190	6225577	UP	18-2743 ③	18-7170	18-2840	18-7153	18-2619-1
200	6225577	UP	18-2743	18-7170	18-2840	18-7153	18-2619-1
200	6225577	UP	18-2743 ③	18-7170	18-2840	18-7153	18-2619-1
215 E/H	2782203	2915034	18-2847	18-7175	—	18-7153 ①	18-2620
225	3856268	4200499	18-2820	18-7170	18-2840	18-7153	18-2614
228	4782330	6225576	18-2820	18-7170	18-2840	18-7153	18-2614
228	6225577	UP	18-2743	18-7170	18-2840	18-7153	18-2619-1
228	6225577	UP	18-2743 ③	18-7170	18-2840	18-7153	18-2619-1
230	6225577	UP	18-2743	18-7170	18-2840	18-7153	18-2619-1
230	6225577	UP	18-2743 ③	18-7170	18-2840	18-7153	18-2619-1
233	4200500	UP	18-2820	18-7170	18-2840	18-7153	18-2614
250	4791300	4898729	18-2820	18-7170	18-2840	18-7153	18-2614
255 TRS	3377316	4203749	18-2847	18-7175	—	—	18-2620
260	4898730	6225576	18-2820	18-7170	18-2840	18-7153	18-2614
260	6225577	UP	18-2743	18-7170	18-2840	18-7153	18-2619-1
260	6225577	UP	18-2743 ③	18-7170	18-2840	18-7153	18-2619-1
280 TRS	4203750	4895399	18-2847	18-7175	—	—	18-2620
470	4208730	6225576	18-2820	18-7170	18-2840	18-7153	18-2614
470	6225577	UP	18-2743	18-7170	18-2840	18-7153	18-2619-1
470	6225577	UP	18-2743 ③	18-7170	18-2840	18-7153	18-2619-1
485	4893835	UP	18-2820	18-7170	18-2840	18-7153	18-2614
488	6225577	UP	18-2743	18-7170	18-2840	18-7153	18-2619-1
488	6225577	UP	18-2743 ③	18-7170	18-2840	18-7153	18-2619-1
888	3106717	UP	18-2820	18-7170	18-2840	18-7153	18-2614
898	4782330	6225576	18-2820	18-7170	18-2840	18-7153	18-2614
898	6225577	UP	18-2743	18-7170	18-2840	18-7153	18-2619-1
898	6225577	UP	18-2743 ③	18-7170	18-2840	18-7153	18-2619-1
R/MR/Alpha One	6225577	UP	18-2743	18-7170	18-2840	18-7153	18-2619-1
R/MR/Alpha One	6225577	up	18-2743 ③	18-7170	18-2840	18-7153	18-2619-1
Bravo (I/II)	B664190	UP	18-2516	—	—	18-7153	18-2615
TR-TRS	4794900	UP	18-2847	18-7175	18-2847	18-7153 ②	18-2620

① Hydraulic Shift Only

② Borg Warner Transmission Only

③ For housing with oil reservoir check valve

# ENGINE

DIAGNOSTICS = **STATS**

SIERRA TOUCH AND TEST SYSTEM

NEW NEW NEW NEW NEW NEW NEW NEW NEW NEW NEW NEW

00110011110011001100110 10101 01100



00110011110011001100110

10101 01100

00110011110011001100110 10101 01100

011000 0011 011 011 011 011 00

0101 0011 0111 00

## IN+ENSIVE CARE FOR MULTIPLE ENGINES

STATS is a portable tool that provides full diagnostic, service and repair capability on the most popular makes and models of watercraft including, outboard, sterndrive, & inboard engines worldwide. Also includes PWCs.



SEASTAR SOLUTIONS®

[www.sierrastats.com](http://www.sierrastats.com)

Explore

formerly known as Teleflex Marine

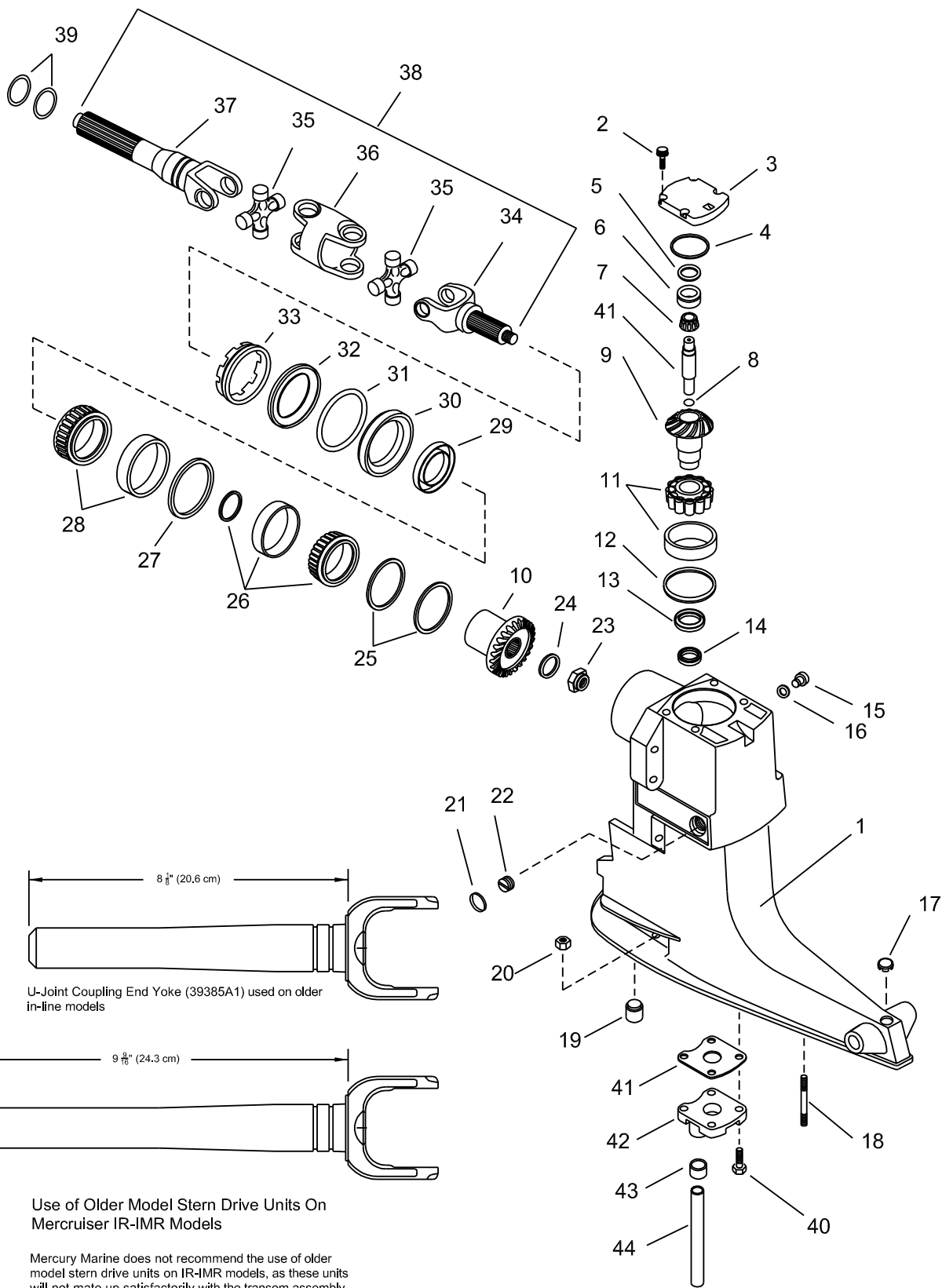

**Use of Older Model Stern Drive Units On Mercruiser IR-IMR Models**

Mercury Marine does not recommend the use of older model stern drive units on IR-IMR models, as these units will not mate up satisfactorily with the transom assembly. In addition, the older model in-line stern drive units are equipped with U-Joint coupling end yoke (39385A1). This yoke is shorter than yoke (59830A1) used on the IR-IMR stern drive units, and therefore, will not fully engage the engine coupler splines. **Use of an older In-Line model stern drive unit on a IR-IMR model will result in a spline failure to coupling and/or yoke.**

Figure #	Description	Part #	O.E.M. #	Qty.
1	Upper Gear Housing	N/A	1547-9412A18	1
2	Screw, Top Cover	18-3231	10-98794	4
3	Top Cover	18-2381	94998A2	1
4	O-Ring, Top Cover	18-7161	25-32546	1
5	Shim, Bearing Cup to Top Cover	18-2283	15-45691A1	1
6	Tapered Roller Bearing	18-1165	31-61100A1	1
7	Upper Drive Shaft	18-2179	45-55796	1
8	O-Ring, Upper Drive Shaft	18-7445	25-55801	1
9./10.	Upper Unit Gear Set			
	1.5:1	18-2201	43-18410A2, 46-18411A2	1
	Rebuild Kit	18-2256	43-803116T1	1
	1.65:1	18-2203	43-45814A5	1
	Rebuild Kit	18-2257	43-803112T1	1
	1.84:1	18-2204	43-75325A3	1
	Rebuild Kit	18-2258	43-803114T1	1
	1.98:1	18-2205	43-55778A3	1
	Rebuild Kit	18-2259	43-803101T1	1
11	Tapered Roller Bearing	18-1161	31-35990A1	1
12	Shim Kit, Bearing Cup to Drive Shaft Housing	18-2293	15-36178A1	1
13	Oil Seal, Upper Drive Shaft Housing	18-2049	26-32511	1
14	Oil Seal, Lower Drive Shaft Housing	18-2056	26-96503	1
15	Vent Screw	18-2244	10-79953A2	1
16	Gasket, Gear Housing Drain Screw	18-2945	12-19183, 12-20260	1
17	Plug, Trim Tab Hole	18-3232	19-47579	1
18	Stud, Drive Shaft Housing	N/A	16-56295	2
19	Bushing, Drive Shaft Housing	18-3236	23-32632	1
20	Nut, Gear Housing Stud	18-2362	11-13439-1	3
21	Welch Plug, Drive Shaft Housing			
	(7/8" OD)	18-4272	19-32652	1
	(1 1/4" OD)	18-4273	19-42682	1
22	Pipe Plug, Water Pocket	18-4265	22-428611	1
23	Nut, Drive Gear to U-Joint	18-3713	11-22339	1
24	Washer, Drive Gear to U-Joint Nut	18-3712	12-45810	1
25	Shim Kit Drive Gear	18-2292	15-35980A1	1
26	Bearing Kit	18-1160	31-35988A2, A12	1
27	Spacer (comes with kit)	18-1160	31-35988A2, A13	1
28	Roller Bearing (comes with kit)	18-1160	31-35988A2, A13	1
29	Oil Seal	18-2003	26-64893	1
30	Carrier Assembly Oil Seal	18-0577	66081A2	1
31	O-Ring	18-7169	25-70937	1
32	Ring, Roller Bearing Retainer	18-4296	35983	1
33	Retaining Nut Drive Shaft Housing	18-3752	816811-1	1
34	Yoke Assembly	18-2125	46020T	1
35	Heavy Duty U-Joint	18-2104	75832A2	1
36	Center Socket	18-2128	39383T	1
37	U-Joint Shaft Coupler	18-2146	59830A1	1
38	Drive Shaft	18-9218	59830A5	1
39	O-Ring	18-7153	25-25439	2
40	Screw, Water Pocket Cover to Drive Shaft Housing	18-3229	10-28668	4
41	Gasket, Water Pocket Cover	18-0894	27-55810	1
42	Water Pocket Cover (Sold as Assembly includes 40-44)	18-3219	42724A3	1
43	Bushing, Water Pump Housing	18-3110	26-38970	1
44	Water Tube	18-3220	32-54236	1

AR As required

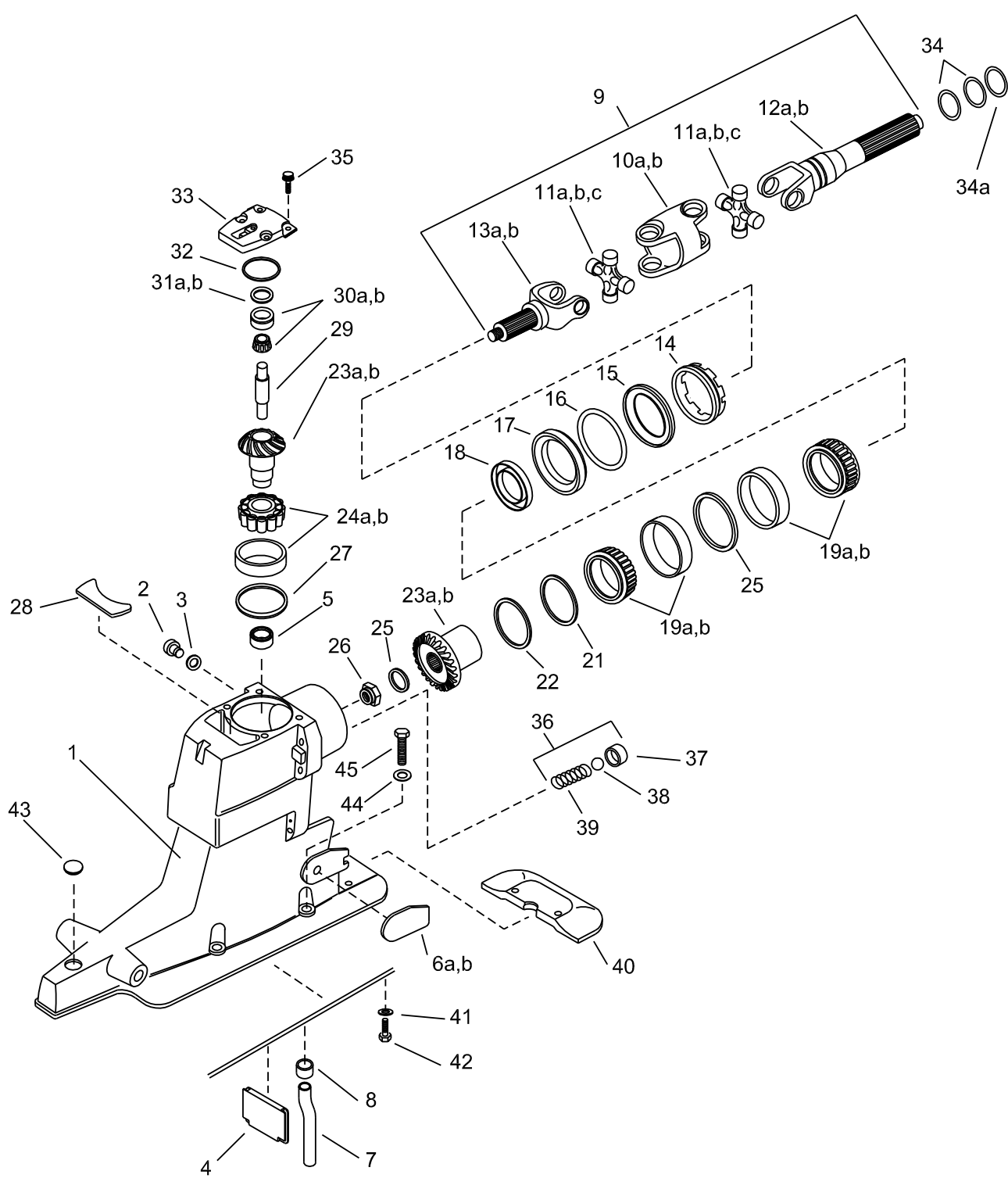

SEE PAGES 708-710 FOR COMPLETE REPLACEMENT HOUSINGS

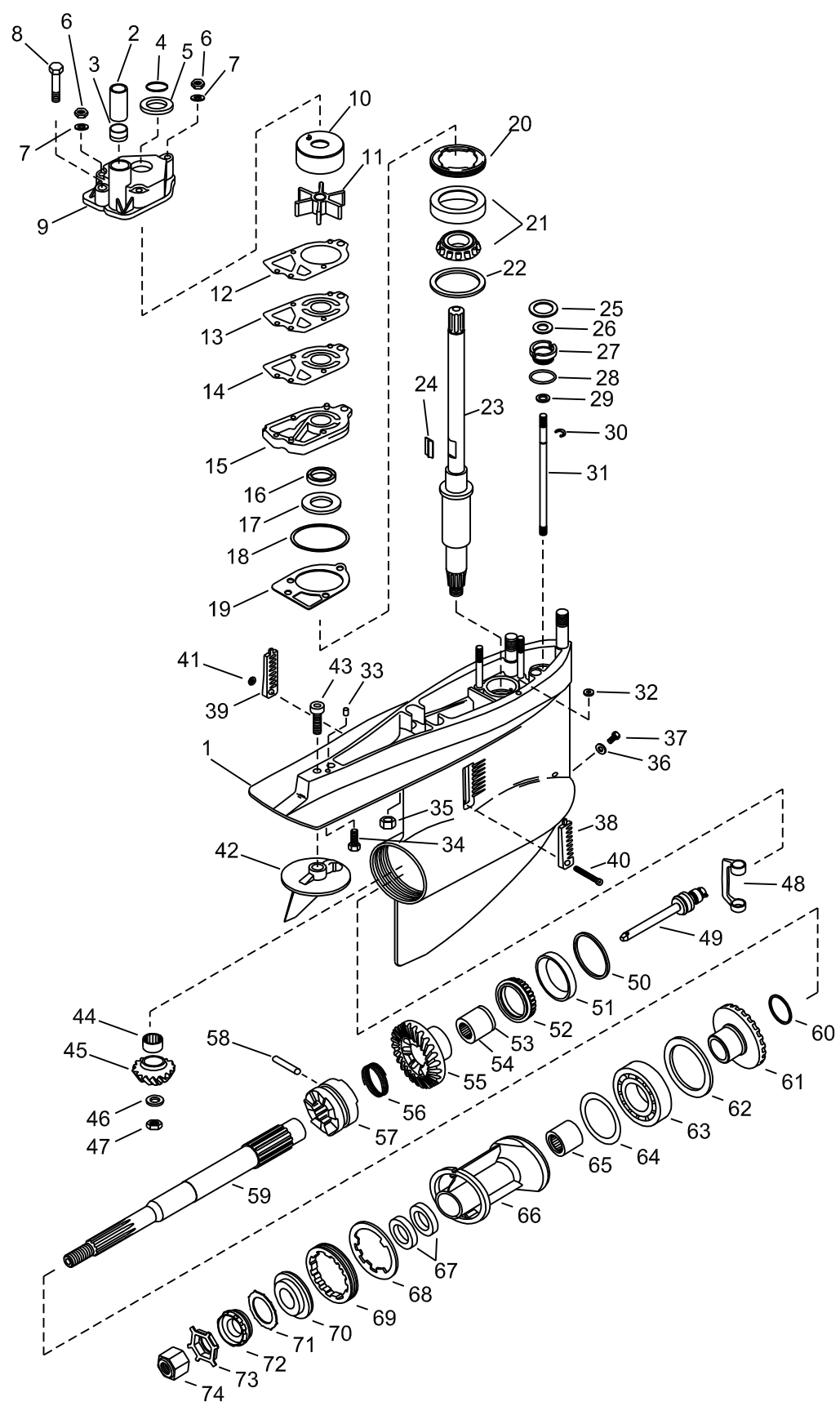

Figure #	Description	Part #	O.E.M. #	Qty.	Figure #	Description	Part #	O.E.M. #	Qty.
1	Drive Shaft Housing (OL100009 & UP)	18-2411	1547-861063A 4	1		Complete Service Kit	18-2364	43-803119T 1	1
						1.84:1/ 1.81:1 Gear Set (tooth count... 17/19)	18-2204	43-75325A3	1
2	Screw	18-2244	10-79953A2	1					
3	Washer	18-2945	12-19183, 12-20260	1		Std. Rebuild Kit	18-2258	43-803114T 1	1
						Complete Service Kit	18-2365	43-803120 T 1	1
4	Filler Wall	N/A	815932	1					
5	Oil Seal	18-2056	26-66302	AR		1.98:1/ 1.94:1 Gear Set (tooth count... 20/24)	18-2205	43-55778A3	1
6a	Wear Pad (Port)	NSS	814386	1		Std. Rebuild Kit	18-2259	43-803101T 1	1
6b	Wear Pad (Stbd)	NSS	814387	1		Complete Service Kit	18-2363	43-803118T 1	1
7	Water Tube	18-3221	32-860220	1	23a	Upper Unit Gear Set (OL100009 & UP)			
8	Seal	NSS	26-88397	1					
9	Yoke Assembly (OK999999 & Below)	18-9218	814819A2	1		1.47:1 Gear Set (tooth count... 20/22)	18-6351	43-853641A2	1
						Complete Service Kit	18-6351K	43-803103T 1	1
	Yoke Assembly (OL100009 & UP)	18-6402	864281A2	1					
10a	Socket, Center (old design)	18-2097	39383T	1		1.62:1 & 2.0:1 Gear Set (tooth count... 24/24)	18-6350	43-853640A2	1
10b	Socket, Center GKN Series	NSS	865503T	1					
11	Cross and Bearing					Complete Service Kit	18-6350K	43-803104T 1	1
11a	D469859 - F679999 (old design)	18-2174	75832A2	2		1.81:1 Gear Set (tooth count... 17/19)	18-6353	43-853643A2	1
11b	F680000- OK999999 (old design- permalube)	18-2097	805536A2	2		Complete Service Kit	18-6353K	43-803105T 1	1
11c	OL100009 & UP (GKN Series)	18-6406	865493A01	2		1.94 & 2.4:1 Gear Set (tooth count... 20/24)	18-6352	43-853642A2	1
12a	Yoke, Coupling End (OK999999 & Below)	18-2146	59830A1	1		Complete Service Kit	18-6352K	43-803106T 1	1
12b	Yoke, Coupling End (OL100009 & UP)	18-6405	865491A01	1	24	Roller Bearing (All but 1.47:1 ratio)	18-1161	43-803106T 1	1
					24a	Roller Bearing (1.47:1 Ratio only)	18-1142	31-32573A 1	1
13a	Yoke, Gear End (OK999999 & Below)	18-2125	46020T	1	25	Washer	18-3712	12-45810	1
					26	Nut	18-3713	11-22339	1
13b	Yoke, Gear End (OL100009 & UP)	18-6403	865492T	1	27	Shim Kit	18-2293	15-36178A1	1
14	Retaining Nut	18-3752	816811-1	1	28	Plug	NSS	861738	1
15	Ring	18-4296	35983	1	29	Drive Shaft, Upper (F680000 & Up)	18-2324	45-55796-1	1
16	O-Ring	18-7169	25-70937	1	30	Bearing Assembly			
17	Carrier Assembly (Set)	18-0577	66081A2	1	30a	F680000 & UP (small bearing)	18-1179	31-32575A1	1
18	Oil Seal	18-2003	26-68493	1	30b	D494569 - F679999 (large bearing)	18-1165	31-61100A1	1
19	Roller Bearing Kit (D469859 - K999999)	18-1160	31-35988A2, A12	1	31	Shim Kit			
					31a	D494569 -F679999	18-2283	15-45691A1	1
19a	Roller Bearing Kit (OL100009 & UP)	18-1182	31-30894A 15	1	31b	F680000 & UP	18-2282	15-32563A1	1
					32	O-Ring	18-7161	25-32546	1
20	Cup Spacer (Included with 18-1160)	18-1160	31-35988A2, A12	AR	33	Cover Assembly, Top (F680000 & Up)	18-2382	828692A1	1
20a	Cup Spacer (Included with 18-1182)	NSS	23-853649A 1	AR	34	O-Ring	18-7153	25-25439	2
					34a	O-Ring	18-7117	25-35027	1
21	Shim Kit	18-2292	15-35980A1	1	35	Screw	18-3231	10-98794	4
22	Shim Spacer	18-2296	15-71013	1	36	Check Valve Kit, Oil Passage	18-2715 KIT	24-17997A1	1
23	Upper Unit Gear Set (OD469859-OK999999)				37	Oil Seal (Included in Kit)	NSS	—	1
					38	Ball (Included in Kit)	NSS	—	1
	1.5:1/ 1.47:1 Gear Set (tooth count... 20/22)	18-2201	43-18410A2, 43-18411A2	1	39	Spring	NSS	—	1
	Std.Rebuild Kit	18-2256	43-803116T 1	1	40	Anode Plate	18-6080	821629A1	1
	Complete Service Kit	18-2358	43-803102T 1	1	41	Lockwasher	N/A	13-78968	2
	1.65:1/ 1.62:1 Gear Set (tooth count... 24/24)	18-2203	43-45814A5	1	42	Screw	18-3229	10-28668	2
	Std. Rebuild Kit	18-2257	43-803112T 1	1	43	Plug	N/A	19-824928	1
					44	Washer	18-4858-9	12-45176	4
					45	Bolt	18-3230	10-816601	4

AR As required

NSS Not Sold Separate

N/A Not Available



SEE PAGES 708-710 FOR COMPLETE REPLACEMENT HOUSINGS

Figure #	Description	Part #	O.E.M. #	Qty.	Figure #	Description	Part #	O.E.M. #	Qty.
1	Gear Housing	18-2401	1623-8951A37	1	44	Pinion Bearing	18-1117	31-42647A1	1
2	Water Tube Guide	18-3109	23-29804	1	45	Lower Alpha Gear Set (pinion gear)	18-2206	43-17064A2, 43-17064A3, 43-42934	1
3	Bushing/Water Pump Housing	18-3110	26-38970	1					
4	O-Ring, Upper Drive Shaft	18-7158	25-30613	1					
5	Slinger	18-7426	25-30271	1	46	Anti-Galling Washer Pinion Gear	18-2343	22-92721	1
6	Stainless Steel Locknuts (5/16-24)	N/A	11-13436	1	47	Pinion Nut	18-3719	11-35921	1
	Stainless Steel Locknuts (1/4-28)	N/A	11-13438	2	48	Shift Crank	18-2130	76865	1
7	Washer	18-4270	12-36001	3	49	Shift Spool Assembly	18-2286	818349A1	1
8	Screw, Water Pump Body to Water Pump Base	N/A	10-96411	1	50	Shim Kit, Forward Gear	18-2285	15-47397A1	1
					51	Tapered Roller Bearing Set	18-1159	31-35928A1	1
9	Upper Pump Housing	18-3116	46-96148A1	1	52	Inner Bearing, Forward Gear	18-1157	31-30895	1
10	Insert Cup	18-3114	48752	1	53	Retaining Clip, Inner Bearing	N/A	—	1
11	Impeller	18-3017	47-89984	1	54		18-1157	31-30895	1
12	Gasket, Upper Water Pump to Wear Plate	18-2915	27-85609-1	1	55	Lower Alpha Gear Set (Forward Gear/Pinion)	18-2206	43-17064A2, 43-17064A3, 43-42934	1
13	Impeller Plate	18-3117	32435	1					
14	Gasket, Wear Plate to Water Pump Base	18-2914	27-85608-1	1					
15	Water Pump Base	18-3420	46-44292A3	1	56	Spring, Retainer - Cross Pin	18-2348	24-30893	1
					57	Sliding Clutch	18-2202	52-66063	1
16	Oil Seal (upper)	18-2013	26-16977	1	58	Cross Pin, Clutch to Actuating Shaft	18-2357	24-30893	1
17	Oil Seal (lower)	18-2014	26-89238	1					
18	O-Ring, Water Pump	18-7176	25-90011	1	59	Propeller Shaft	18-2166	44-66060, 44-6606-3	1
19	Gasket, Water Pump Base to Gear Housing	18-2919	27-42631-1	1	60	Lower Alpha Gear Set (Reverse Gea-NSS)	18-2206	43-17064A2, 43-17064A3, 43-42934	1
20	Retainer, Drive Shaft Bearing	18-2346	824519	1					
21	Tapered Roller Bearing Drive Shaft	18-1143	31-36387A1	1					
22	Shim Kit, Lower Drive Shaft Bearing	18-2294	15-42637A1	1	62	Thrust Ring, Bearing Carrier	18-2342	68100-1	1
23	Drive Shaft	18-2180	45-42634	1	63	Ball Bearing	18-1155	30-88957A1	1
24	Drive Key Water Pump Impeller	N/A	28-56654	1	64	O-Ring, Bearing Carrier	18-7159	25-31534	1
25	Shift Shaft Washer	18-4267	12-29395	1	65	Needle Roller Bearing	18-1158	31-30956	1
26	Washer Rubber Shift Shaft Bushing	18-2340	12-31266	1	66	Bearing Carrier	18-2191	73020A-14	1
27	Shift Bushing	18-2154	23-30617A2	1	67	Oil Seals, Bearing Carrier	18-2002	26-76868	2
28	O-Ring, Shift Shaft Bushing	18-7153	25-25439	1	68	Tab Washer	18-2298	14-18323	1
29	Washer, Lower Shift Shaft	NSS	12-27880	1	69	Spanner Nut	18-3751	79448	1
30	Retaining Clip, Shift Shaft	NSS	53-29641	1	70	Thrust Washer	18-4220	13171, 77987	1
31	Stainless Steel Shift Shaft	18-2150	77481-1	1	71	Continuity Washer	N/A	13-423511	1
32	Oil Passage Seal	18-2944	26-45577	1	72	Brass Castle Washer	18-3714	12-31211A2	1
33	Dowel Pin, Gear Housing to Drive Shaft Housing	18-3226	10-30720	2	73	Tab Washer	18-3200	14-31210, 14-816629	1
34	Screw, Gear Housing to Drive Shaft Housing	18-2361	10-30206	1					
35	Nut, Gear Housing to Drive Shaft Housing	18-2362	11-13439-1	2					
36	Gasket, Gear Housing Drain Screw	18-2945	12-19183, 12-20260	1					
37	Plug, Oil Fill/Drain	18-2244	10-79953A2	1					
38	Insert, Water Pick (Stbd)	18-3199	93423-1	1					
39	Insert, Water Pick (Port)	118-3198	93424-1	1					
40	Screw, Insert to Gear Housing	18-3197	10-76156	1					
41	Nut, Insert Screw	18-2344	11-45812	1					
42	Trim Tab	18-6011	31640A1	1					
43	Screw, Trim Tab Gear Housing	18-6245	10-32470	1					

N/A Not Available

NSS Not Sold Separate

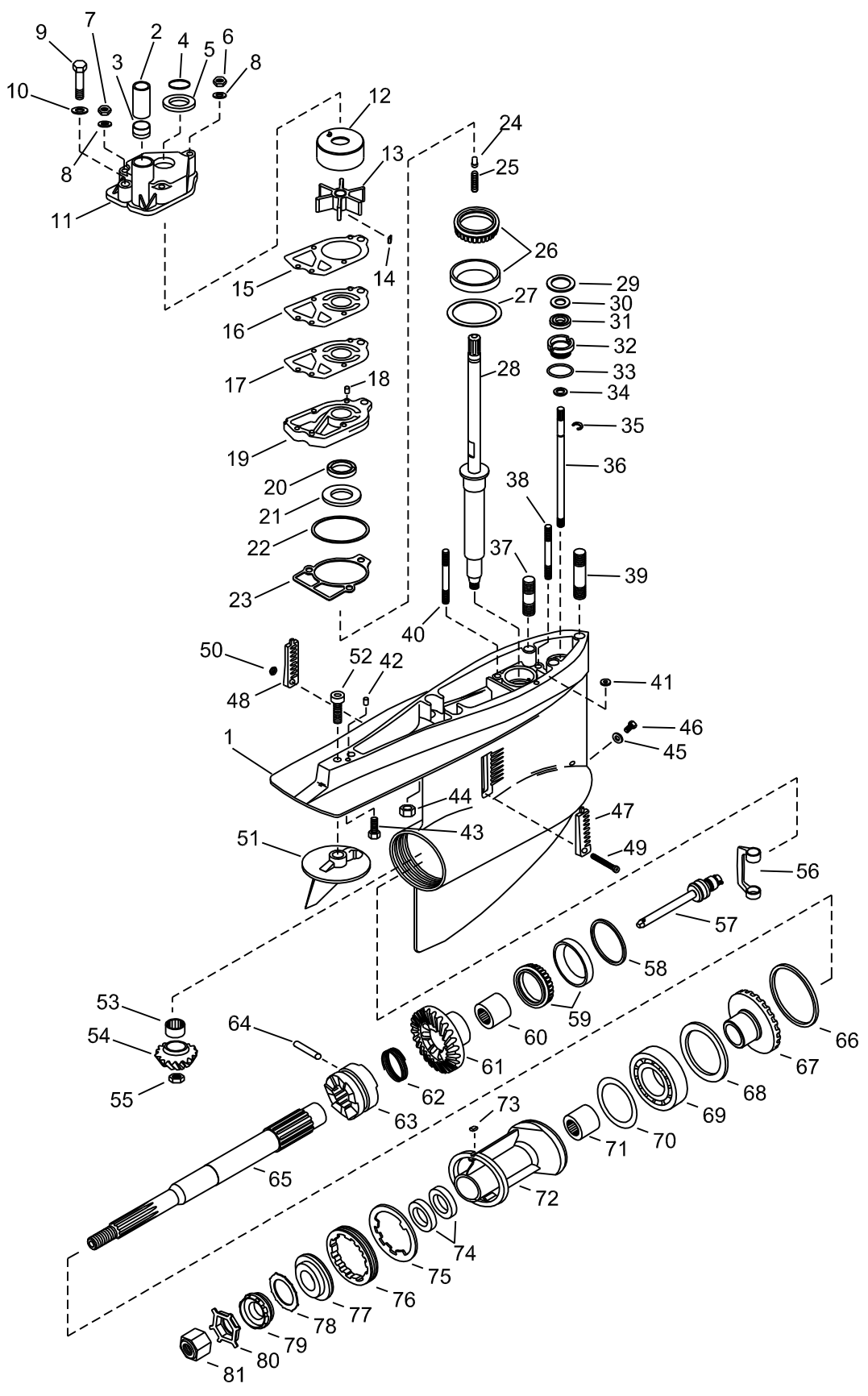

SEE PAGES 708-710 FOR COMPLETE REPLACEMENT HOUSINGS

Figure #	Description	Part #	O.E.M. #	Qty.	Figure #	Description	Part #	O.E.M. #	Qty.
1	Lower Gear Housing	18-2402	1623-5356A4	1	43	Screw, Gear Housing to Drive Shaft Housing	18-2361	10-30206	1
2	Water Tube Guide	18-3109	23-29804	1	44	Nut Gear Housing to Drive Shaft Housing	N/A	11-82671015	2
3	Bush Water Pump Housing	18-3110	26-38970	1	45	Gasket, Gear Housing Drain Screw	18-2945	12-19183, 12-20260	1
4	O-Ring, Upper - Drive Shaft	18-7158	25-30613	1	46	Plug, Oil Fill/Drain	18-2244	10-79953A2	1
5	Slinger	18-7426	25-30271	1	47	Insert, Water Pick (Stbd)	N/A	66885	1
6	Stainless Steel Locknuts (5/16-24)	18-3723	11-45592	1	48	Insert, Water Pick (Port)	N/A	66884	1
7	Stainless Steel Locknuts (1/4-28)	18-3722	11-20361, 11-35888	2	49	Screw Insert to Gear Housing	18-3197	10-76156	1
8	Washer	18-4275	12-29245	3	50	Nut, Insert Screw	18-2344	11-45812	1
9	Screw	18-3226	10-30720	1	51	Trim Tab	18-6011	31640A1	1
10	Washer, Water Pump Body	18-4270	12-36001	1	52	Screw, Trim Tab to Gear Housing	18-6245	10-32470	1
11	Upper Pump Housing	18-3116	46-96148A1	1	53	Needle Roller Bearing	18-1150	31-92366A1	1
12	Insert Cup	18-3114	48752	1	54	Lower Unit Gear Set (pinion gear)	18-2200	23-96084A4	1
13	Impeller	18-3017	47-89984	1	55	Pinion Nut	18-3719	11-35921	1
14	Drive Key	N/A	28-56654	1	56	Shift Crank	18-2130	76865	1
15	Gasket, Upper Water Pump to Wear Plate (upper)	18-2915	27-85609-1	1	57	Shift Spool Assembly	19755A2	18-2286	1
16	Impeller Plate	18-3117	32435	1	58	Shim Kit, Forward Gear Bearing	18-2285	15-47397A1	1
17	Gasket, Upper Water Pump to Wear Plate (lower)	18-2914	27-85608-1	1	59	Tapered Roller Bearing	18-1159	31-35928A1	1
18	Dowel Pin	18-3227	17-35973	2	60	Needle Roller Bearing	18-1157	31-30895	1
19	Water Pump Base	18-3417	46-57234A1	1	61	Lower Unit Gear Set (Forward)	18-2200	23-96084A4	1
20	Oil Seal (upper)	18-2026	26-16977	1	62	Spring, Retainer, Cross Pin	18-2348	24-30893	1
21	Oil Seal (lower)	18-2014	26-89238	1	63	Sliding Clutch	18-2202	52-66063	1
22	O-Ring (2.175 ID) & (2.1091 ID)	18-7176, 18-7196	25-90011	1	64	Cross Pin, Clutch to Clutch Actuating Shaft	18-2348	17-30632	1
23	Gasket, Water Pump Base to Gear Housing	18-2826	27-85610-1	1	65	Propeller Shaft	18-2166	44-66060, 44-66060-3	1
24	Pin, Driveshaft	N/A	17-30545	1	66	Shim Kit, Thrust Ring to Gear Housing	18-2284	15-31535A1	1
25	Spring	N/A	24-34576	1	67	Lower Unit Gear Set (reverse)	18-2200	43-96084A4	1
26	Tapered Roller Bearing	18-1164	31-53079A1	1	68	Thrust Ring, Bearing Carrier	18-3759	35915	1
27	Shim Kit, Drive Shaft Bearing	18-2295	15-57007A	1	69	Ball Bearing	18-1155	30-88957A1	1
28	Drive Shaft	18-2167	45-41939A1	1	70	O-Ring	18-7159	25-31534	1
29	Shift Shaft Washer	18-4267	12-29395	1	71	Needle Roller Bearing	18-1158	31-30956	1
30	Washer, Rubber Shift Shaft Bushing	18-2340	12-31266	1	72	Bearing Carrier Assembly	18-2191	73020A14	1
31	Oil Seal	26-89236	18-2009	1	73	Key, Locating - Bearing Carrier	N/A	28-30281	1
32	Shift Bushing	18-2154	23-30617A2	1	74	Oil Seals	18-2002	26-76868	2
33	O-Ring	18-7153	25-25439	1	75	Tab Washer	18-2299	14-79447	1
34	Washer, Lower Shift Shaft Bushing	N/A	12-27880	1	76	Spanner Nut	18-3751	79448	1
35	Retaining Clip, Shift Shaft	18-4295	53-29641	1	77	Thrust Washer	18-4220	13171, 77987	1
36	Stainless Steel Shift Shaft	18-2150	77481-1	1	78	Continuity Washer	NSS	13-423511	1
37	Stud, Gear Housing to Drive Shaft Housing (1-31/32")	N/A	16-56298	2	79	Brass Castle Washer	18-3714	12-31211A2	1
38	Stud, Water Pump to Gear Housing (3 - 3/8")	N/A	16-562972	1	80	Tab Washer	18-3200	14-31210, 14-816629	1
39	Stud, Gear Housing to Drive Shaft Housing (3 - 3/16")	N/A	16-46911	1	81	Prop Nut	18-3700	11-52707	1
40	Stud, Water Pump to Gear Housing (3 - 1/4")	N/A	16-69501	2					
41	Oil Passage Seal	18-2944	26-45577	1					
42	Dowel Pin, Gear Housing to Drive Shaft Housing	N/A	17-35973	2					

AR As required

NSS Not Sold Separate

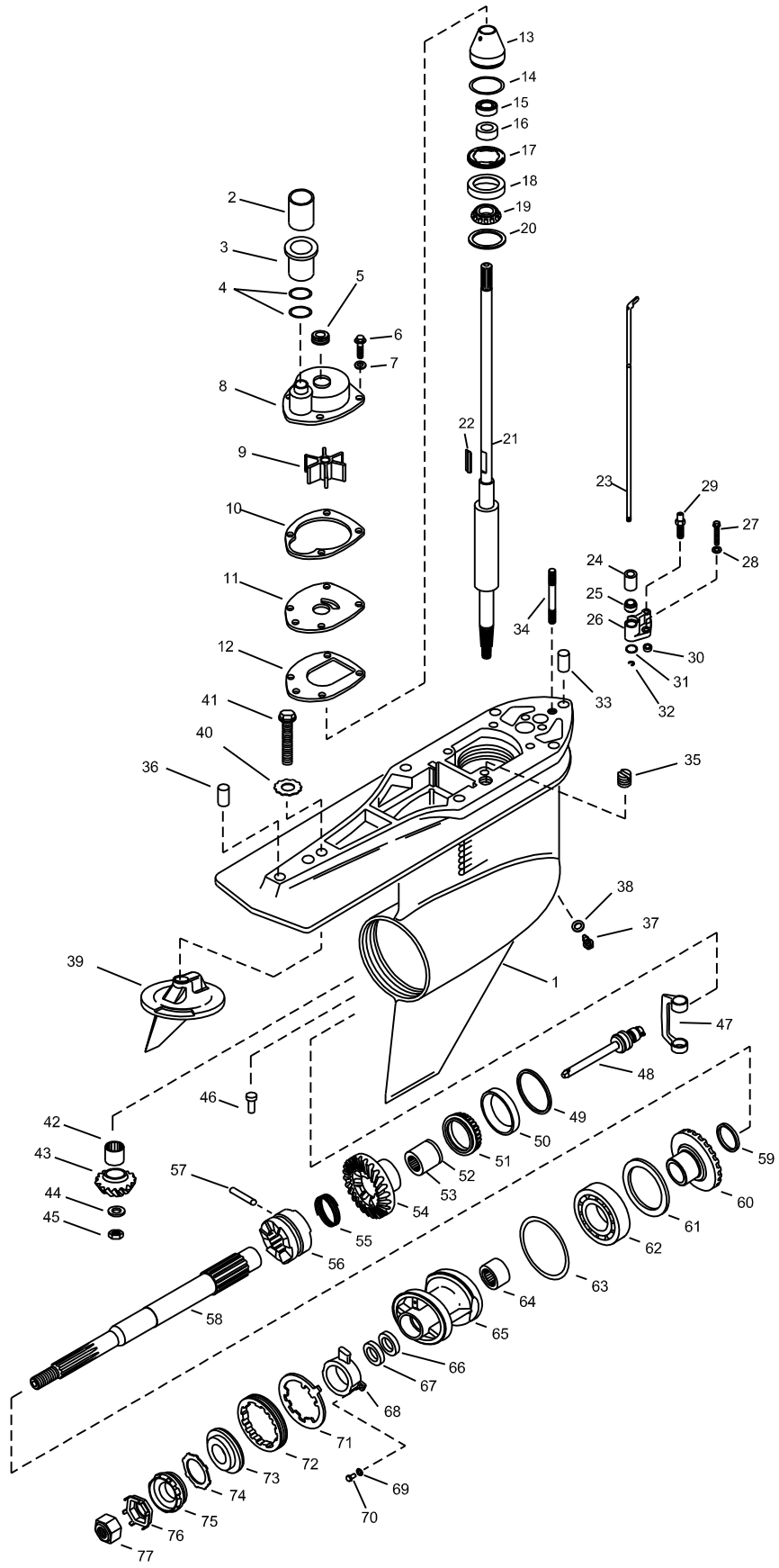

SEE PAGES 708-710 FOR COMPLETE REPLACEMENT HOUSINGS

Figure #	Description	Part #	O.E.M. #	Qty.	Figure #	Description	Part #	O.E.M. #	Qty.
1	Gear Housing	18-2415	1623-815822A36	1	48	Shift Spool Assembly	18-2286	818349A1	1
2	Sleeve	—	23-816573	1	49	Shim Kit	18-2285	15-47397A1	1
3	Coupling	18-3151	816597A1	1	50 & 51	Forward Gear, Outer Bearing	18-1159	31-35928A1	1
4	O-Rings	18-7420	25-21836	2	52	Retaining Clip, Inner Bearing	NSS	—	1
5	Face Seal	18-2599	26-816575A2	1	53	Forward Gear, Inner Bearing	18-1157	31-30895	1
6	Screw, 10-32 X 5/8	NSS	10-806290	4	54	Forward Gear	18-2206	43-828072A2	1
7	Star Washer	NSS	13-69432	4	55	Cross Pin Spring	18-2348	24-30893	1
8	Water Pump Body	18-3147	817275A1	1	56	Sliding Clutch	18-2202	52-824112	1
9	Impeller	18-3056	47-43026-2	1	57	Cross Pin	18-2357	17-30632	1
10	Gasket	18-2563	27-817277	1	58	Propeller Shaft	18-2166	44-824110	1
11	Face Plate	18-3122	817276	1	59	Spacer	—	23-824108	1
12	Gasket	18-2564	27-43033-1	1	60	Reverse Gear	18-2206	43-828072A2	1
13	Seal Carrier	18-2354	821759A2	1	61	Thrust Ring	18-2342	681001	1
14	O-Ring	18-7176	25-90011	1	62	Ball Bearing	18-1155	30-88957A1	1
15	Seal	18-2013	26-16977	1	63	O-Ring	18-7159	25-31534	1
16	Seal	18-2014	26-89238	1	64	Roller Bearing	18-1158	31-30956	1
17	Cover Nut	18-2346	824519	1	65	Bearing Carrier	18-2376	818763A10	1
18 & 19	Bearing, Upper Driveshaft (1.50-1.65 Ratio)	18-1143	31-36387A1	1	66	Seal	18-2002	26-14077	1
					67	Seal	18-2076	26-12224	1
	Bearing, Upper Driveshaft (1.47-1.62 Ratio)	18-1193	31-33138A1	1	68	Carrier Anode	18-6093	806105A1	1
					69	Lockwasher, Anode Mounting	—	13-69432	2
20	Shim Kit	18-2294	15-42637A1	1	70	Bolt, Anode Mounting	—	10-806290	2
21	Drive Shaft (1:47 & 1:62)	18-2331	45-853648	1	71	Tab Washer	18-2298	14-18323	1
					72	Cover Nut	18-3751	79448	1
	Drive Shaft (1:50 & 1:65)	18-2261	45-816919	1	73	Thrust Hub	18-4220	13171	1
					74	Continuity Washer	NSS	13-42351-1	1
22	Impeller Drive Key	18-3293	28-43037	1	75	Splined Washer	18-3714	12-31211A2	1
23	Shift Shaft	18-2320	815919A1	1	76	Tab Washer	18-3200	14-31210	1
24	Sleeve	18-2349	23-67370	1	77	Propeller Nut	18-3700	11-52707	1
25	Seal	18-2009	26-89236	1		Seal Kit (Not Pictured)	18-2646-1	26-816575A3	1
26	Shift Rod Bushing Assembly	18-2353	23-815921A21	1					
27	Screw, 10-32 X 5/8	NSS	10-806290	2					
28	Star Washer	NSS	13-69432	2					
29	Speedometer Pickup Fitting	—	NSS	1					
30	O-Ring	18-7440-1	25-36318	1					
31	O-Ring	18-7440-1	25-36318	1					
32	Retaining Ring	18-4295	53-29641	1					
33	Dowel Pin	—	17-43044	1					
34	Stud, Mounting	—	16-57984	1					
35	Seal	18-2944	26-45577	1					
36	Dowel Pin	—	17-43044	1					
37	Plug	18-2375	22-67892A1	1					
38	Gasket	18-2945	12-19183	1					
39	Trim Tab	18-6016	76214A5	1					
40	Washer, Anode Mounting	—	13-806210	1					
41	Bolt, Anode Mounting	—	10-806327	1					
42	Pinion Bearing	18-1117	31-42647A1	1					
43	Pinion Gear	18-2206	43-828072A2	1					
44	Washer	18-2343	12-92721	1					
45	Nut	18-3719	11-35921	1					
46	Pin	—	17-37972-1	1					
47	Shift Crank	18-2130	76865	1					

NSS Not Sold Separate



**18-2292 SHIM KIT**  
 Drive Gear  
 Replaces: 15-35980A1  
 Contains (1) each  
 .002, .003, .005, .006, .010, .025  
 For: Mercuriser Vazer



**18-2293 SHIM KIT**  
 Upper Bearing  
 Replaces: 15-36178A1  
 Contains (1) each .002, .003, .015  
 (2) each .010  
 For: Mercuriser Vazer

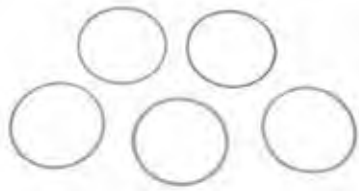

**18-2294 SHIM KIT**  
 Lower Drive Shaft Bearing  
 Replaces: 15-8M0063267, 15-42637A1  
 Contains (1) each  
 .002, .003, .005, .010, .020  
 For: Mercuriser Vazer



**18-2295 SHIM KIT**  
 Lower Drive Shaft Bearing  
 Replaces: 15-57007A1  
 Contains (1) each  
 .002, .003, .005, .010, .020  
 For: Mercuriser Vazer

**SHIMS**

Part #	Size	O.E. #
* <b>18-2282</b>	Kit	15-32563A1 For: Mercuriser Vazer
* <b>18-2283</b>	Kit	15-45691A1
* <b>18-2284</b>	Kit	15-31535A1
* <b>18-2285</b>	Kit	15-47397A1
<b>18-2296</b>	.055	15-71013



- \* **18-2282** (1) each .002, .003, .005, .010, .025
- \* **18-2283** (1) each .002, .003, .005, .010
- \* **18-2284** (1) each .002, .003, .005, .010, .020
- \* **18-2285** (1) each .002, .003, .005, .010, .020

**SHIM KIT APPLICATION**

HP	Serial Number	Bearing to Top Cover Kit	Bearing Cup to Drive Shaft Housing	Drive Gear	Drive Gear Spacer	Drive Shaft Bearing to Gear Housing	Reverse Gear	Forward Gear Kit
120/140	2062141 thru 2791956	18-2282 ②	18-2293	18-2292	18-2296	18-2295	18-2284 ⑤	18-2285
120/140	2791957 thru 4893634	18-2283 ④	18-2293	18-2292	18-2296	18-2295	18-2284 ⑤	18-2285
120/140	4893635 thru 6225576	18-2283	18-2293	18-2292	18-2296	18-2295	—	18-2285
160	2065190 thru 2763441	18-2282 ②	18-2293	18-2292	18-2296	18-2295	18-2284 ⑤	18-2285
165	2763442 thru 4890459	18-2283 ④	18-2293	18-2292	18-2296	18-2295	18-2284 ⑤	18-2285
165	4890460 & UP	18-2283	18-2293	18-2292	18-2296	18-2295	—	18-2285
888	3106717 & UP	18-2283 ③	18-2293	18-2292	18-2296	18-2295	18-2284 ⑤	18-2285
898/228	4782330 thru 4898729	18-2283	18-2293	18-2292	18-2296	18-2295	18-2284 ⑤	18-2285
898/228	4898730 thru 6225576	18-2283	18-2293	18-2292	18-2296	18-2295	—	18-2285
225-S	3856268 thru 4200499	18-2283	18-2293	18-2292	18-2296	18-2295	18-2284 ⑤	18-2285
233	4200500 & UP	18-2283	18-2293	18-2292	18-2296	18-2295	18-2284 ⑤	18-2285
250	4791300 thru 4898729	18-2283	18-2293	18-2292	18-2296	18-2295	18-2284 ⑤	18-2285
260	4898730 thru 6225576	18-2283	18-2293	18-2292	18-2296	18-2295	—	18-2285
470	4208730 thru 4893934	18-2283	18-2293	18-2292	18-2296	18-2295	18-2284 ⑤	18-2285
470	4893835 thru 6225576	18-2283	18-2293	18-2292	18-2296	18-2295	—	18-2285
485	4893835 & UP	18-2283	18-2293	18-2292	18-2296	18-2295	—	18-2285
R/MR/Alpha One	6225577 & UP (R)	18-2283	18-2293	18-2292	18-2296	18-2295	—	18-2285
R/MR/Alpha One	6225577 & UP (MR)	18-2283	18-2293	18-2292	18-2296	18-2294	① ⑥	18-2285
Alpha Gen II	D494569 thru F679999	18-2283	18-2293	18-2292	18-2296	18-2294	① ⑥	18-2285
Alpha Gen II	F680000 & UP	18-2282		18-2293	18-2292	18-2296	18-2294① ⑥	—

- ① For .208" Shim use Part Number 18-0208
- ① For .210" Shim use Part Number 18-0210
- ① For .212" Shim use Part Number 18-0212
- ① For .214" Shim use Part Number 18-0214
- ① For .218" Shim use Part Number 18-0218

- ① For .220" Shim use Part Number 18-0220
- ① For .222" Shim use Part Number 18-0222
- ① For .224" Shim use Part Number 18-0224
- ① For .226" Shim use Part Number 18-0226

- ② S/N #2187468 & Below use 18-2293
- ③ S/N #4433200 & UP Only
- ④ S/N #4530702 & UP Only
- ⑤ Kit
- ⑥ For Counter Rotation Only



**18-2400 COMPLETE LOWER GEAR CASE**  
 Replaces: 1623-815822A53  
 For: Ratios 1.47, 1.62, 1.81 & 1.94  
 Fits: Gen II (1998 & up) 0L100040 & up



**18-2411 DRIVE SHAFT HOUSING ASSEMBLY**  
 Replaces: 1547-861063A4  
 For: Gen II Upper (1998-up), 0L100040-up, 1.47:1 Ratio/Gen II Upper (1998-up) 0L100040-up, 1.62/2.00:1 Ratio's/Gen II Upper (1998-up), 0L100040-up, 1.81:1 Ratio/Gen II Upper (1998-up), 0L100040-up, 1.94/2.40:1 Ratios  
 Used with: 18-2416, 18-2417, 18-2418, 18-2419 Complete Upper Gear Cases





**18-2415**  
**GEAR HOUSING ASSEMBLY**  
 Replaces: 1623-815822A36  
 For: Ratios 1.47, 1.62  
 Gen II (1998 & up), (0L100040 & up)  
 Used with: 18-2400 Complete Lower Gear Case



**18-2416**  
**COMPLETE UPPER GEAR CASE**  
 Replaces: 1547-861063A12  
 For: Alpha Gen II (1991 & UP) for gear ratios 1.47:1, 1.50:1.  
 Used with 18-2411 Drive Shaft Housing Assembly



**18-2417**  
**COMPLETE UPPER GEAR CASE**  
 Replaces: 1547-861063A10  
 For: Alpha Gen II (1991 & UP) for gear ratios 1.62:1, 1.65:1, 2.0:1.  
 Used with: 18-2411 Drive Shaft Housing Assembly



**18-2418**  
**COMPLETE UPPER GEAR CASE**  
 Replaces: 1547-861063A8  
 For: Gen II (1991 & UP) for gear ratios 1.81:1, 1.84:1.  
 Used with: 18-2411 Drive Shaft Housing Assembly



**18-2419**  
**COMPLETE UPPER GEAR CASE**  
 Replaces: 1547-861063A6  
 For: Alpha Gen II (1991 & UP) for gear ratios 1.98:1 and 2.40:1  
 Used with: 18-2411 Drive Shaft Housing Assembly



**18-2450**  
**COMPLETE UPPER GEAR CASE**  
 Replaces: 1547-9412A20  
 1.5:1/1.47:1



**18-2451**  
**COMPLETE UPPER GEAR CASE**  
 Replaces: 1547-9412A21  
 1.65:1/1.62:1



**18-2452**  
**COMPLETE UPPER GEAR CASE**  
 Replaces: 1547-9412A22  
 1.84:1/1.81:1



**18-2453**  
**COMPLETE UPPER GEAR CASE**  
 Replaces: 1547-9412A23  
 1.98:1/1.94:1



**18-2443**  
**COMPLETE LOWER GEAR CASE**  
 Replaces: 1623-8951A43  
 For: R/MR/ALPHA

**18-2401  
LOWER GEAR HOUSING**

Replaces: 1623-8951A27,  
1623-8951A37  
For: MR/ALPHA Style  
Bore size 3.2635-3.2650. Includes tapered roller bearing for non-tractor 14/28 or 17/28 gears. When installing new gears use 18-2206-1 gear kit which includes tapered roller bearing 18-1156 for tractor 13/21 gears.



**18-2358  
UPPER UNIT  
GEAR REPAIR KIT**

Replaces: 43-803102T1  
For: 20-22 Teeth: 1.50:1 (1.47:1)  
Gen II applications serial number range up to OK999999 only



**18-2363  
UPPER UNIT  
GEAR REPAIR KIT**

Replaces: 43-803118T1  
For: 20-24 Teeth: 1.98:1 (1.94/2.40:1)  
Gen II applications serial number range up to OK999999 only



**18-2364  
UPPER UNIT  
GEAR REPAIR KIT**

Replaces: 43-803119T1  
For: 24-24 Teeth: 1.65:1 (1.62:1)  
Gen II applications serial number range up to OK999999 only



**18-2365  
UPPER UNIT  
GEAR REPAIR KIT**

Replaces: 43-803120T1  
For: 17-19 Teeth: 1.84:1 (1.81:1)  
Gen II applications serial number range up to OK999999 only



**18-6350K  
UPPER UNIT  
GEAR REPAIR KIT**

Replaces: 43-803104T1  
For: Gen II (1998 & Up)(S/N OL100040 & Up)  
1.62:1 and 2.00:1 Ratio



**18-6351K  
UPPER UNIT  
GEAR REPAIR KIT**

Replaces: 43-803103T1  
For: Gen II (1998 & Up)(S/N OL100040 & Up)  
1.47:1 Ratio



**18-6352K  
UPPER UNIT  
GEAR REPAIR KIT**

Replaces: 43-803106T1  
For: Gen II (1998 & Up)(S/N OL100040 & Up)  
1.94:1 and 2.40:1 Ratio



**18-6353K  
UPPER UNIT  
GEAR REPAIR KIT**

Replaces: 43-803105T1  
For: Gen II (1998 & Up)(S/N OL100040 & Up)  
1.81:1 Ratio



**18-2201  
UPPER UNIT GEAR SET**

Replaces: 43-18410A2,  
43-18411A2  
Includes: (1) 18-1142  
Mercury #31-32573A1  
(1.5:1 Ratio)  
(Drive Gear = 22 teeth Driven Gear = 20 teeth)  
For most V-8 Drives and Gen II (S/N K999999 & BELOW)



Stern Drive Model	Beg. S/N	End. S/N	Stern Drive Model	Beg. S/N	End. S/N
225	3856268	4200499	888	3106717	& UP
260	4898730	6225576	V8R/MR/AlphaOne	6225577	& UP
898/228	4782330	6225576			



**18-2203**  
**UPPER UNIT GEAR SET**  
 Replaces: 43-45814A5  
 (1.65:1 Ratio) (Drive Gear = 24 teeth  
 Driven Gear = 24 teeth)  
 For: 6 Cyl. Inline S/N K999999 & BELOW



**18-2204**  
**UPPER UNIT GEAR SET**  
 Replaces: 43-75325A3  
 (1.84:1 Ratio)  
 (Drive Gear = 17 teeth Driven Gear = 19 teeth)  
 For: V-6 and 470/485 (4 Cyl. etc.) and Gen II  
 (S/N K999999 & BELOW)



**18-2205**  
**UPPER UNIT GEAR SET**  
 Replaces: 43-55778A3  
 (1.98:1 Ratio)  
 (Drive Gear = 20 teeth Driven Gear = 24 teeth)  
 For: 120/140 (S/N 2791957 & UP) and Gen II  
 (S/N K999999 & BELOW)



**18-6350**  
**UPPER UNIT GEAR SET**  
 Replaces: 43-853640A2  
 For: Gen II Upper (1998-up), 0L100040-up,  
 1.62/2.00:1 Ratios (24-24 Teeth)  
 Used with: 18-2417 Complete Upper Gear Case



**18-6351**  
**UPPER UNIT GEAR SET**  
 Replaces: 43-853641A2  
 For: Alpha I (Gen II) (1998-up), 0L100040-up,  
 1.47:1 Ratio (20-22 Teeth)  
 Used with: 18-2416 Complete Upper Gear Case



**18-6352**  
**UPPER UNIT GEAR SET**  
 Replaces: 43-853642A2  
 For: Alpha I (Gen II) (1998-up), 0L100040-up,  
 1.94:1, 2.40:1 Ratios (20-24 Teeth)  
 For: Mercruiser Vazer  
 Used with: 18-2411 Drive Shaft Housing Assembly,  
 18-2419 Complete Upper Gear Case



**18-6353**  
**UPPER GEAR KIT**  
 Replaces: 43-853643A2  
 1.81 Ratio Upper Gear Set, 17-19 Teeth  
 For: Alpha I Gen II 1998-up/0L00040-up  
 For: Mercruiser Vazer

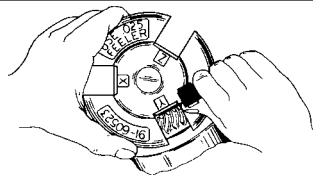

FIG. #1

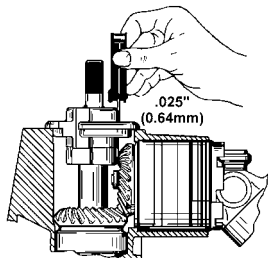

FIG. #2

**FIGURES #1 - #2**

Provides two separate views of the upper gear housing driven gear being properly shimmed using the Sierra installation tools.

**FIGURES #3 - #4**

Provides the same views of the drive gear being shimmed in the same application.

**NOTE:**

This installation **cannot** be performed correctly without the Sierra 18-9856 shim tool. Improper installation will result in gear failure. The .025 referenced in FIG #2 & FIG #4 is achieved when .026 will not fit the clearance but .025 will.

A service manual should always be consulted for step-by-step instructions.

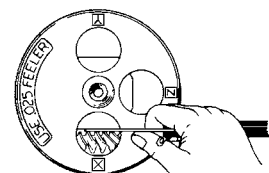

FIG. #3

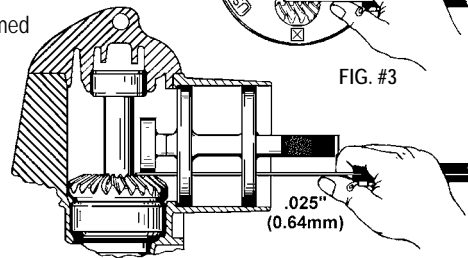

FIG. #4



**18-2256**  
**UPPER GEAR KIT**  
 Replaces: 43-803116T1  
 Most V-8 Drives (1.5:1 Ratio)

— CONTAINS —

Part #	Description	O.E. #	Qty.
18-2201	Upper Unit Gear Set	43-18410A2	1
18-2648	Seal Kit	26-32511A2	1
18-2619-1	Outdrive Gasket Set	27-94996A1	1
18-2820	Drive Shaft Housing to Bell Housing Gasket	27-64818	1
18-2743	Drive Shaft Housing to Bell Housing Gasket	27-94996-2	1
18-1160	Bearing	31-35988A2	1
18-1165	Bearing	31-61100A1	1
18-1142	Bearing	31-35990A1	1

— CONTAINS —

Part #	Description	O.E. #	Qty.
18-2203	Gear Set	43-45814A5	1
18-2648	Seal Kit	26-32511A2	1
18-2619-1	Outdrive Gasket Set	27-94996A1	1
18-2820	Drive Shaft Housing to Bell Housing Gasket	27-64818	1
18-1160	Bearing	31-35988A2	1
18-1161	Bearing	31-35990A1	1
18-1165	Bearing	31-61100A1	1
18-2743	Drive Shaft Housing to Bell Housing Gasket	27-94996-2	1

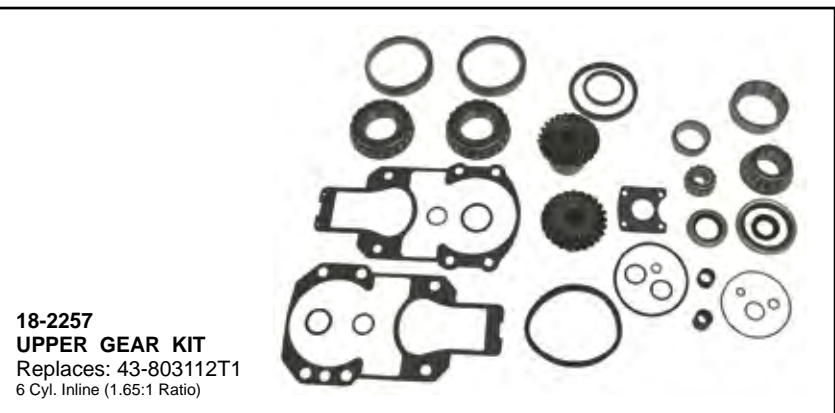

— CONTAINS —

Part #	Description	O.E. #	Qty.
18-2204	Gear Set	43-75325A3	1
18-2648	Seal Kit	26-32511A2	1
18-2619-1	Outdrive Gasket Set	27-94996A1	1
18-2820	Drive Shaft Housing to Bell Housing Gasket	27-64818	1
18-1160	Bearing	31-35988A2	1
18-1161	Bearing	31-35990A1	1
18-2743	Drive Shaft Housing to Bell Housing Gasket	27-94996-2	1
18-1165	Bearing	31-61100A1	1

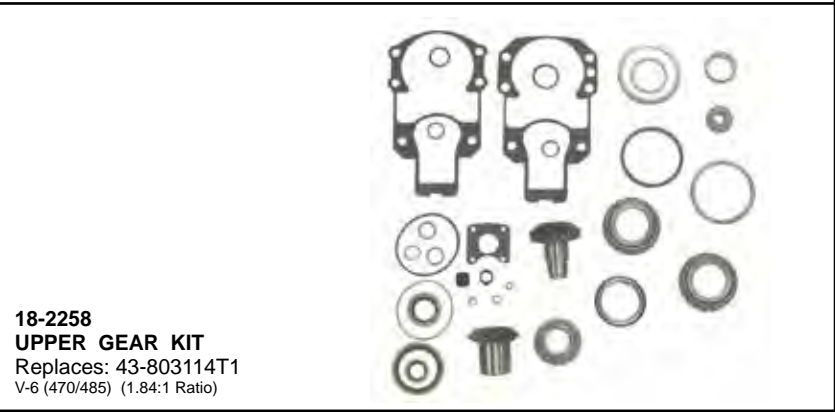

— CONTAINS —

Part #	Description	O.E. #	Qty.
18-2205	Gear Set	43-55778A3	1
18-2648	Seal Kit	26-32511A2	1
18-2619-1	Outdrive Gasket Set	27-94996A1	1
18-2820	Drive Shaft Housing to Bell Housing Gasket	27-64818	1
18-1160	Bearing	31-35988A2	1
18-1161	Bearing	31-35990A1	1
18-1165	Bearing	31-61100A1	1
18-2743	Drive Shaft Housing to Bell Housing Gasket	27-94996-2	1

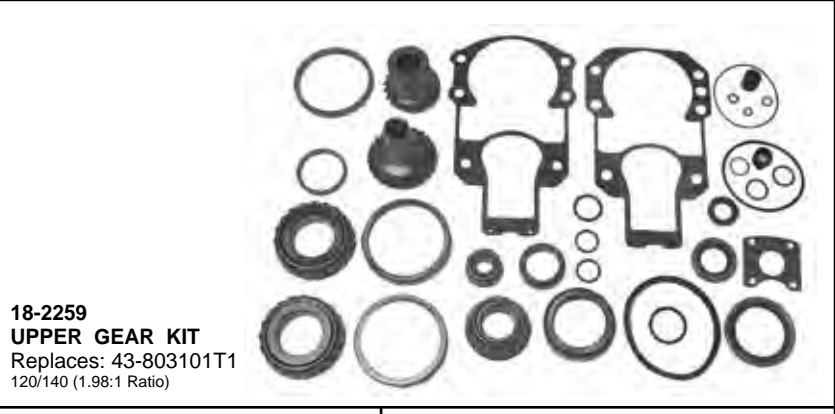



**18-6401  
YOKE ASSEMBLY**  
Replaces: 12784A10, 864244A2  
For Bravo I, II, III (OB664190 - up)  
(1998-05)



**18-6402  
YOKE ASSEMBLY**  
Replaces: 864281A2  
For: Alpha I (Gen II) (1998 & up) (OL100040 & up) GKN Style  
For: Mercruiser Vazer



**18-9218  
YOKE ASSEMBLY**  
Replaces: 814819A2  
For all #1, R/MR/ALPHA Gen II  
OK999999 & Below (1971-97)



**18-2128  
CENTER SOCKET**  
Replaces: 39383T, 343831  
(Rockwell)  
Fits IA/IB/IC & EZ, MC-I, R, MR, Alpha One, Gen II  
(OL949778 & below), Bravo (OM111207 & below),  
MC II & TS



**18-1711  
U-JOINT**  
Replaces: 862132T  
For: Bravo One, Two, & Three (All Ratios), Bravo One X/  
Two X, Three X (All Ratios), Bravo One XR/XZ(All Ratios),  
Bravo One XR Sportmaster (All Ratios) & Integrated Transom



**18-2097  
U-JOINT**  
Permalube  
Replaces: 805536A2  
For: Generation II F680000 & UP



**18-2104  
U-JOINT**  
Heavy Duty  
Replaces: 75832A2, 75832T  
Includes both straight and 90° grease fitting.  
(Rockwell)  
Fits all #1 and ALPHA I Units S/N 1684188-B418818.  
Also TR/TRS and II SSM.



**18-2174  
U-JOINT**  
Heavy Duty  
Replaces: 75832A3, 758321, 75832T1  
Includes both straight and 90° grease fitting.  
(Rockwell)  
Fits ALPHA I Units S/N B418819 & above.  
Also fits ALPHA I SS & BRAVO



**18-6406  
U-JOINT ASSEMBLY**  
Replaces: 865496A01, 865493A01  
GKN new style with external clips.  
Fits: Alpha I Gen II OL949779 & UP,  
Bravo OM111208 & UP  
For: Mercruiser Vazer



**18-8311  
GIMBAL HOUSING REBUILD KIT**  
Fits: Alpha One



**18-8312  
GIMBAL HOUSING REBUILD KIT**  
Fits: Gen II



**18-8313  
GIMBAL HOUSING REBUILD KIT**  
Fits: Bravo



**18-21001  
GIMBAL BEARING**  
Replaces: 30-879194A02  
Fits: MC-1, R, MR and Alpha(1974-97),  
Gen II(1991-97), Bravo I/II/III (1988-95)



**18-21006  
GIMBAL BEARING**  
Replaces: 30-879194A01  
Fits: Gen II (1998-10), Bravo I/II/III & X/XR/XZ (1996-10)



**18-21005  
GIMBAL BEARING**  
Replaces: 30-862540A3  
Fits: All Bravos, Alpha One Gen II (1998-up)



**18-21005K  
SEAL & GIMBAL BEARING KIT**  
Fits: Gen II (1998-Up) and all Bravo



**18-2101  
GIMBAL BEARING**  
Replaces: 30-36418  
(Link-Belt)



**18-2100  
HEAVY DUTY GIMBAL BEARING**  
Replaces: 30-60794A4  
(Link Belt)  
Fits: Mercruiser- 120HP / 140HP  
(2791957-6225576) ( With Gimbal Trim Sender), 165HP (2763442 & Up),  
225S (3856268-4200499), 228HP (4782330 & Up), 233HP (4200500 & Up),  
250HP (4791300 & Up)



**18-2100K  
SEAL & GIMBAL  
BEARING KIT**  
Fits: 1, R, MR and Alpha (1974-97)



**18-1705  
HINGE PIN**  
Replaces: 77123  
(with grease port) For gimbal housing  
Fits: Alpha, Alpha Gen II  
S/N 0M815638 & Lower



**18-1706  
HINGE PIN**  
Replaces: 10-86801  
For gimbal housing  
Fits: Alpha Gen II S/N 0M85639 & UP  
Bravo All Models with trim sender



**18-2381  
UPPER DRIVE UNIT CAP**  
Replaces: 94998A2, 94998A4  
S/N 6225577 & Later Alpha I, except Gen II



**18-2382  
UPPER DRIVE UNIT CAP**  
Replaces: 828692A1  
For: Gen II S/N F680000 & UP

**GIMBAL BEARING APPLICATION**

Model	Year Range	Beginning Serial No.	Ending Serial No.	Gimbal Bearing	Model	Year Range	Beginning Serial No.	Ending Serial No.	Gimbal Bearing
60	1965-1972	1830753	3225967		898 / 228	1977-1982	4782330	6225576	18-21001
80	1965-1972	1830753	3225967		250 / 260	1977-1982	1791300	6225576	18-21001
90	1965-1972	1830753	3225967		R / MR / ALPHA I	1983-1990	6225577	& UP	18-21001
I	1963	1534570	1684187		ALPHA I SS	1986-1989	A545004	& UP	18-21001
IA	1964	1684186	1777798	18-2101	ALPHA I GEN II	1991-1997	D469859	K999999	18-21001
IB	1964	1684188	1777798	18-2101	ALPHA I GEN II	1998-2010	L100040	& UP	18-21001
IC	1964	1684188	1777798	18-2101	VASER	2007-2010	W995000	& UP	
EZ-SHIFT	1964	1684188	1777798	18-2101	BRAVO I	1988-1995	B664190	F729999	18-21001
120 / 140	1967-1973	2062141	3780849	18-2101	BRAVO II	1988-1995	B664190	F729999	18-21001
120 / 140	1974-1982	3780850	6225576	18-21001	BRAVO III	1988-1995	B664190	F729999	18-21001
470 / 485	1976-1982	4208730	6225575	18-21001	BRAVO I	1996-2010	F730000	& UP	18-21006
160 / 165	1967-1973	2065190	3780849	18-2101	BRAVO II	1996-2010	F730000	& UP	18-21006
165	1974-1981	3780850	& UP	18-21001	BRAVO III	1996-2010	F730000	& UP	18-21006
888	1971-1973	3106717	3784374	18-2101	X / XR / XZ	1996-2010	F730000	& UP	18-21006
888	1974-1977	3784375	& UP	18-21001	BLACK HAWK	1994-1995	F186717	& UP	18-21001
225 / 233	1974	3856268	& UP	18-21001					



**18-2179  
DRIVE SHAFT**  
Replaces: 45-55796



















**18-2324  
DRIVE SHAFT**  
Replaces: 45-557961  
For: Gen II (S/N F680000 & UP),  
Mercruiser Vazer



**18-3713  
LOCK NUT**  
Replaces: 11-22339  
5/8" - 18

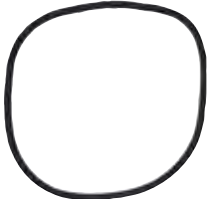

**18-3712  
CARRIER NUT WASHER**  
Replaces: 12-45810

 <p><b>18-3752 RETAINING NUT</b> Replaces: 816811-1, 8168112</p>	 <p><b>18-4296 SPACER RING</b> Replaces: 35983 (Upper Housing)</p>	 <p><b>18-0577 CARRIER OIL SEAL ASSEMBLY</b> Replaces: 66081A2</p>	 <p><b>18-3219 WATER TUBE &amp; COVER ASSEMBLY</b> Replaces: 42724A3 For: Merc I and Alpha I drives Models: I, 1A, 1B, 1C, 1CEZ, 120, 140, 160, 165, 888, 898, 228, 225-S, 233, 250, 260, 470, 485, R, MR, Alpha <b>18-3229 BOLT</b> Replaces: 10-28668</p>
 <p><b>18-2322 SHIFT SHAFT</b> Replaces: 621041 For: I and Alpha I</p>	 <p><b>18-2169 SHIFT ARM</b> Replaces: 45589A3</p>	 <p><b>18-3749 UPPER SHIFT SHAFT</b> Replaces: 816685 For: Alpha Gen II (1991-98)</p>	
 <p><b>18-2599 FACE SEAL &amp; TOOL</b> Replaces: 26-816575A2 For: ALPHA I GENERATION II</p>	 <p><b>18-2622 BELL HOUSING BUSHING KIT</b> Replaces: 23-805041A2</p>	 <p><b>18-3760 BELL HOUSING BUSHING KIT</b> Replaces: 23-806036A1 For: GEN II Serial # F680000 &amp; UP</p>	
 <p><b>18-2161 SHIFT ARM</b> Replaces: 45518A2</p>	 <p><b>18-2170 SHIFT ARM SCREW</b> Replaces: 10-45590</p>	 <p><b>18-2162 SHIFT CABLE SLIDE &amp; SCREW</b> Replaces: 33981T</p>	 <p><b>18-2162E SHIFT CABLE SLIDE &amp; SCREW</b> For Extreme Cables Only</p>
<p>PKG. OF 5</p>  <p><b>18-2163 18-2163-9① SHIFT SLIDE SCREW</b> Replaces: 10-31700</p>	<p>PKG. OF 5</p>  <p><b>18-2163E-9① SHIFT SLIDE SCREW</b> For Extreme Cables Only</p>	 <p><b>18-2715 CHECK VALVE KIT</b> Replaces: 24-17997A1 For: Alpha I Generation II and Bravo I, II, and III Drives</p>	 <p><b>18-2724 TRANSOM SEAL</b> Replaces: 3713 For: Alpha Gen II, All Bravo</p>

① Priced per Package

— CONTAINS —

Part #	Description	O.E. #	Qty.
18-2619-1	Outdrive Gasket Set	27-64818A3	
		27-94996A1,Q2	1
18-2100	Gimbal Bearing	30-60794A4	1
18-2161	Shift Arm	45518A2	1
18-2751	U-Joint Bellows	60932A4	1
18-2750	Exhaust Bellows	32734A3, 18654A1	1
18-2753-1	Shift Cable Bellows	74639	1
18-3601	Water Intake Hose	32-32461	1
18-3602	Water Intake Hose	32-41725-33	1
18-7310	Hose Clamp	—	2
18-7314	Stainless Steel Hose Clamp	—	1
18-7315	Stainless Steel Hose Clamp	—	1



**18-2601-1  
TRANSOM SEAL KIT**  
Replaces: 30-803097T1  
R, MR, ALPHA 1 (1983-90) S/N 6225577 & UP  
ALPHA 1 SS (1986-89) S/N OA 545004 & UP

— CONTAINS —

Part #	Description	O.E. #	Qty.
18-2100	Gimbal Bearing	30-60794A4	1
18-2751	U-Joint Bellows	60932A4	1
18-2760	Exhaust Tube	78458A1	1
18-3601	Water Intake Hose	32-32461	1
18-3602	Water Intake Hose	32-41725-33	1
18-2743	Drive Shaft Housing to Bell Housing Gasket	27-94996-2	1
18-2840	Bell Housing Gasket	27-35982	1
18-7153	O-Ring	25-25439	1
18-7117	O-Ring	25-35027	1
18-7310	Hose Clamp	—	2
18-7170	O-Ring	25-33504	1
18-7312	Hose Clamp	—	1
18-2753-1	Shift Cable Bellows	74639	1
18-7321	Bellows Clamp	54-38863	1



**18-8205  
TRANSOM SEAL KIT**  
Replaces: 30-803098T1  
For: 1, R, MR, Alpha 1 with exhaust tube

— CONTAINS —

Part #	Description	O.E. #	Qty.
18-3602	Water Intake Hose	32-41725-33	1
18-7310	Hose Clamp	—	2
18-7312	Hose Clamp	—	1
18-2753-1	Shift Cable Bellows	74639	1
18-7321	Bellows Clamp	54-38863	1
18-2100	Gimbal Bearing	30-60794A4	1
18-2743	Drive Shaft Housing to Bell Housing Gasket	27-94996-2	1
18-2840	Bell Housing Gasket	27-35982	1
18-7153	O-Ring	25-25439	1
18-7170	O-Ring	25-33504	1
18-7117	O-Ring	25-35027	1
18-2750	Exhaust Bellows	18654A1, 32734A3	1
18-2747	Drive Bellows	816431A1	1



**18-8206-1  
TRANSOM SEAL KIT**  
Replaces: 30-803099T1  
For: Alpha 1 Gen II

— CONTAINS —

Part #	Description	O.E. #	Qty.
18-2753-1	Shift Cable Bellow	74639	1
18-2100	Gimbal Bearing	30-60794A4	1
18-2756	U-Joint Bellows	86840A3	1
18-2750	Exhaust Bellows	32734A3	1
18-2760	Exhaust Tube	78458A1	1
18-3603	Water Hose	32-43437	1
18-2615	Outdrive Mounting Kit	16755A1	1



**18-8212  
TRANSOM SEAL KIT**  
Replaces: 30-803100T1  
For: All Bravos 1982 & up



**18-8213  
TRANSOM SEAL KIT**  
Replaces:  
Mercury 30-803097T1  
For: R, MR, Alpha 1 (1983-90)  
S/N 6225577-0D469858; Alpha  
1 SS (1986-89) S/N OA545004  
& Up



**18-8217  
TRANSOM SEAL KIT**  
Replaces:  
Mercury 30-803098T1  
For: R, MR, Alpha 1 (1983-90)  
w/exhaust tube S/N 6225577-  
0D469858; Alpha 1 SS (1986-89)  
w/exhaust tube S/N OA545004  
& Up



**18-8218  
TRANSOM SEAL KIT**  
Replaces:  
Mercury 30-803099T1  
For: Alpha 1 Gen II (1991 &  
Up) S/N 0D469859 & Up







**18-8219  
TRANSOM SEAL KIT**  
Replaces:  
Mercury 30-803100T1  
For: Bravo I/II/III (1988 &  
Up) S/N 0B664190 & Up;  
Blackhawk (1994-95) S/N  
0F186717 & Up



 <p><b>18-2747</b> <b>U-JOINT BELLOWS</b> Alpha 1, Gen II Replaces: 816431A1</p>	 <p><b>18-2750</b> <b>EXHAUST BELLOWS</b> All #1 Units, Gen II, TRS, &amp; Bravo I, II, III Replaces: 32734A3, 18654A1 (Includes 18-7314 Clamp)</p>	 <p><b>18-2751</b> <b>U-JOINT BELLOWS</b> All #1 units with ridge (S/N 3469428 &amp; UP) Replaces: 60932A4 (Includes 18-7316 Clamp)</p>
--	---	--

 <p><b>18-2752</b> <b>U-JOINT BELLOWS</b> All #1 units without ridge (S/N 3443920 &amp; BELOW) Replaces: 36223A2 (Includes 18-7316 Clamp)</p>	<p>① <b>18-2753-2D</b></p>  <p><b>18-2753-2</b> <b>SHIFT CABLE BELLOWS</b> All #1, #2 units, Alpha, Bravo I, II, III Replaces: 74639, 74639A2 (Includes 18-7321 Clamp)</p>	 <p><b>18-2756</b> <b>U-JOINT BELLOWS</b> Replaces: 86840A3, 86840A05 Fits all Bravo and Blackhawk models</p>	 <p><b>18-1710</b> <b>BELLOW FLANGE RING</b> Replaces: 862209 Fits: All Bravo</p>
--	---	---	--

 <p><b>18-1728</b> <b>BELLOW FLANGE RING</b> Replaces: 816607 Fits: Alpha One (GenII) (1991 and Up)</p>	 <p><b>18-2746</b> <b>EXHAUST BOOT</b> Replaces: 32-14358T (4" Lower Tube)</p>	 <p><b>18-2748</b> <b>EXHAUST BOOT</b> Replaces: 32-44348T (4" Upper Tube)</p>	 <p><b>18-2759</b> <b>EXHAUST TUBE</b> Replaces: 53114A1</p>
--	--	---	--

 <p><b>18-2760</b> <b>EXHAUST TUBE</b> Replaces: 78458A1 (Includes 18-7314 Clamp) For: #1, Bravo I, II, III</p>	 <p><b>18-2761</b> <b>EXHAUST TUBE</b> 3" I.D. Replaces: 32-90949T</p>	 <p><b>18-2762</b> <b>EXHAUST TUBE</b> Replaces: 70981A3</p>	 <p><b>18-2770</b> <b>EXHAUST TUBE</b> Replaces: 32-807458T</p>
--	---	--	--

① Items ending in "D" are Display Packaged - Regular number is Non-Display

**BELLOWS APPLICATION**

Model	Years	Serial #	Exhaust Bellows	Shift Cable Bellows	U-Joint Bellows
I/1A/1B/1C & EZ	1963-1966	1534570-2065186	18-2750	18-2753-2	18-2752
120/140/160/165	1967-1972	2062141-3443920	18-2750	18-2753-2	18-2752
120/140/160/165	1972-1982	3469428-6225576	18-2750	18-2753-2	18-2751
888	1971-1972	3106717-3472477	18-2750	18-2753-2	18-2752
888	1973-1977	3472478 & Up	18-2750	18-2753-2	18-2751
225/233	1974-1977	3856268 & Up	18-2750	18-2753-2	18-2751
898/228/250/260	1977-1982	4782330-6225576	18-2750	18-2753-2	18-2751
R/MR/Alpha One	1983-1990	6225577 & Up	18-2750	18-2753-2	18-2751
R/MR/Alpha One	1983-1990	6225577 & Up	18-2760 ②	18-2753-2	18-2751
Alpha One Gen II	1991 & Newer	0D469859 & Up	18-2750	18-2753-2	18-2747
Bravo I/II/III	1988 & Newer	0B664190 & Up	18-2750	18-2753-2	18-2756
Bravo I/II/III	1988 & Newer	0B664190 & Up	18-2760 ②	18-2753-2	18-2756
Blackhawk	1994-1995	0F18677 & Up	18-2750	18-2753-2	18-2756
Blackhawk	1994-1995	0F18677 & Up	18-2760 ②	18-2753-2	18-2756
II	1962-1969	1474909-2671321	—	18-2753-2	—
215H	1970	2782203-2909034	—	—	18-2752
215E	1970-1972	2909035-2915034	—	18-2753-2	18-2752
TR/TRS	1973-1993	3377316 & Up	—	—	18-2751

② Tube



PKG. OF 5

**18-9031  
BELLOWS ADHESIVE**  
Replaces: 92-86166  
2 Fluid oz.



**18-7321  
18-7321-9<sup>2</sup>  
BELLOWS CLAMP**  
Replaces: 54-38863



**INNER SHIFT CABLE**  
**18-2159**  
Replaces: 66069A2  
Use in 18-2157, 18-2158 and their Mercruiser equivalent as replacement wire and tube  
Stranded Core 73"  
**18-2189**  
Replaces: 38399A2  
Use with 18-2248  
Inner Core Wire 59"



**18-2160  
SHIFT CABLE  
SUPPORT TUBE**  
Replaces: 32-38377  
Replaces tube on 18-2157, 18-2158 & 18-2159



**18-2248  
SHIFT CABLE  
ASSEMBLY**  
Replaces: 73723A1  
Mercruiser #1 Drives S/N 1562900-6225576 for forward installation into bell housing. Has new style armored strand construction. (No support tube) 54" conduit with hardware package.



**18-2157**  
Replaces:  
41951A1, 19543A4  
Mercruiser 1 drives S/N 6225577 & UP For AFT installation into bell housing. Has old style stranded core wire with soldered tip (Uses Support Tube).  
**18-2158**  
Mercruiser #1 Drives S/N 1562900-6225576 for forward installation into bell housing. Has old style stranded core wire with soldered tip. (Uses support tube) 63" conduit



**SHIFT CABLE ASSEMBLY**

**18-2190  
SHIFT CABLE**  
Replaces: 19543A4, A10  
Mercruiser 1 drives S/N 6225577 & UP  
For AFT installation into bell housing. For use in applications using core wire with armored strand construction (No Support Tube). 63" Conduit with hardware package.



**18-2190E  
SHIFT CABLE**  
Replaces: 19543A4, 19543A10  
S/N 6225577 & UP. For AFT installation into bell housing. For use in applications using core wire with armored strand construction (No Support Tube). 63" Conduit with hardware package. Lower Shift Cable- Alpha One (Gen II) (1991-97)  
Requires 18-9806E (Xtreme Shift Cable Tool) to complete installation



**XTREME**

**18-2145  
SHIFT CABLE**  
Replaces: 815471A3, A6

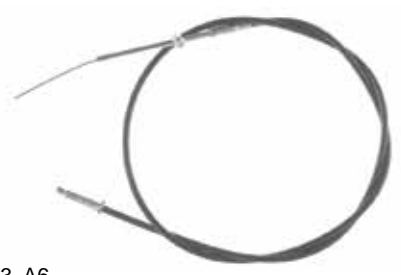

**18-2145E  
SHIFT CABLE**  
Replaces: 815471, A3, A6  
Bravo One, Two, & Three (All Ratios), Bravo One X/Two X, Three X (All Ratios), Bravo One XR/XZ (All Ratios), Bravo One XR Sportmaster (All Ratios) & Integrated Transom



**XTREME**

**18-9806E  
SHIFT CABLE TOOL**  
Installs and removes shift cables on MC-I, R-MR, Alpha I, Alpha I Gen II drive units. Use with 18-2190 and 18-2190E cables.



**18-2149  
SHIFT CABLE GUIDE**  
Replaces: 43433  
For: Alpha & Bravo cables



PKG OF 25



**18-2303**  
**18-2303-9<sup>①</sup>**  
**ANCHOR**  
**SCREW SET**  
 Replaces: 10-20518  
 For: #1R, MR, Alpha, Alpha I,  
 Gen II & Bravo



**18-3754**  
**CABLE ANCHOR**  
 Replaces: 43436  
 For: #1R, MR, Alpha, Alpha I, Gen II  
 & Bravo



**18-2600**  
**LOWER SHIFT CABLE KIT**  
 — CONTAINS —

Part #	Description	O.E. #	Qty.
18-2619-1	Outdrive Gasket Set	27-94996A1	1
18-2753-1	Shift Cable Bellows	74639	1
18-2248	Shift Cable Assembly	73723A1	1
18-2162	Shift Slide & Screw	33981T	1
18-2149	Shift Cable End Kit	43433	1
18-2163	Shift Slide Screw	10-31700	1
18-2743	Drive Shaft Housing to Bell Housing Gasket	27-94996-2	1
18-2820	Drive Shaft Housing to Bell Housing Gasket	27-64818	1
18-2843	Drive Shaft Housing to Bell Housing Gasket	27-94996	1



**18-2603**  
**LOWER SHIFT**  
**CABLE KIT**  
 Replaces: 19543T-1  
**ALPHA I GENERATION II**  
 — CONTAINS —

Part #	Description	O.E. #	Qty.
18-2619-1	Outdrive Gasket Set	27-94996A1	1
18-2753-1	Shift Cable Bellows	74639	1
18-2190	Shift Cable Assembly	19543A4	1
18-2743	Drive Shaft Housing to Bell Housing Gasket	27-94996-2	1



**18-2603E**  
**LOWER SHIFT**  
**CABLE KIT (EXTREME)**  
 Replaces: 19543T1  
 For: Alpha I Gen II  
 Requires 18-9806E (Xtreme Shift Cable Tool) to complete installation



**18-2604**  
**LOWER SHIFT CABLE KIT**  
 Replaces: 815471T1  
**BRAVO**  
 — CONTAINS —

Part #	Description	O.E. #	Qty.
18-2145	Bravo Shift Cable	815471A3	1
18-2149	Shift Cable End Kit	43433	1
18-2753-1	Shift Cable Bellows	74639	1
18-2615	Outdrive Gasket Set	—	1



**18-2604E**  
**LOWER SHIFT CABLE KIT**  
**(EXTREME)**  
 Replaces: 815471T1  
 For: Bravo

STAINLESS STEEL CLAMPS		
Part #	Diameter Size	Std. #
18-7307	5/16" to 7/8"	006
18-7308	9/16" to 1 1/16"	010
18-7309	9/16" to 1 1/4"	012
18-7310	1 1/16" to 1 1/2"	016
18-7311	3/4" to 1 3/4"	020
18-7312	1 1/16" to 2"	024
18-7313	1 9/16" to 2 1/2"	032
18-7314 <sup>②</sup>	2 9/16" to 3 1/2"	048
18-7315	2 1/2" to 4 1/2"	064
18-7316 <sup>③</sup>	3" to 5"	072
18-7317	5" to 7"	104

**GRADE 316**  
**STAINLESS STEEL WORM GEAR HOSE CLAMPS**



All components are manufactured from Marine Grade 316 stainless steel. These clamps are designed to fit many applications from 5/16" to 7" diameter hoses.



**18-2175**  
**ENGINE**  
**COUPLER**  
 Replaces: 18643A7  
 Flex plate style for late model, small crankshaft bolt pattern, style engines



**18-2195**  
**ENGINE**  
**COUPLER**  
 Replaces: 12632A7  
 Flex plate style for GM 4 Cyl engines with late style, small crankshaft bolt pattern

<sup>①</sup> For use with 3" Bellows <sup>②</sup> O.E. #54-32533 <sup>③</sup> O.E. #s 54-31765, 54-815504372





**18-4442**  
**ENGINE ALIGNMENT TOOL**  
 Replaces: 91-57797A3  
 For use with all #1 units

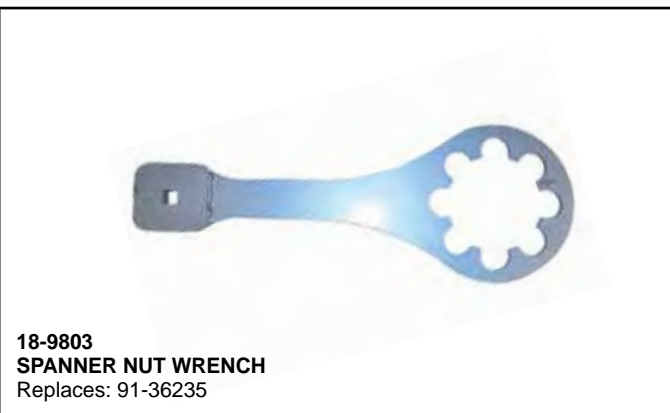

**18-9803**  
**SPANNER NUT WRENCH**  
 Replaces: 91-36235



**18-9200**  
**SPLINE GREASE**  
 14 oz.  
 Replaces: 92-816391A4  
 Specialty grease used in the assembly of engine yokes and couplers



**18-2200**  
**LOWER UNIT GEAR SET**  
 Replaces: 43-96084A4  
 888 S/N 3106717 & UP #1 Units S/N 3469428 & UP Except, MR/ALPHA Units (which have no pre-load pin in the top of the drive shaft).



**18-2410**  
**FORWARD GEAR SET**  
 Replaces: 43-96084A7  
 For: "R" drive



**18-2360**  
**PINION & FORWARD GEAR SET**  
 Replaces: 43-828072A3  
 13-21 Teeth



**18-2206-1**  
**LOWER UNIT GEAR SET**  
 Replaces: 43-878087A2 + 43-828073A1, 43-828072A2  
 For: All MR/ALPHA/Gen II (Except Gen II 2.00-2.40 ratios)



**18-2409**  
**REVERSE GEAR**  
 Replaces: 43-92320T  
 For: "R" drive (28 teeth)



**18-2406**  
**FORWARD GEAR SET**  
 Replaces: 43-878087A2  
 For: MR/Alpha/Gen II lower S/N D469859 & UP



**18-2408**  
**REVERSE GEAR**  
 Replaces: 43-828073A1  
 For: Alpha I/Gen II lower S/N D469859 & UP

**18-2404**  
**GEAR REPAIR KIT**  
 Replaces: 43-803079T1  
 For: "R" drive



— CONTAINS —

Part #	Description	O.E. #	Qty.
18-2200	Lower Unit Gear Set	43-96084A4	1
18-2202	Sliding Clutch	52-66063	1
18-1157	Needle Roller Bearing	31-30895	1
18-1155	Ball Bearing	30-88957A1	1
18-1159	Tapered Roller Bearing	31-35928A1	1
18-2285	Shim	15-47397A1	1
18-3719	Pinion Nut	11-35921	1
18-2299	Tab Washer	14-79447	1

**18-2405**  
**GEAR REPAIR KIT**  
 Replaces: 43-803091T1  
 For: MR/Alpha I



— CONTAINS —

Part #	Description	O.E. #	Qty.
18-2652	Lower Gear Housing Seal Kit	26-33144A2	1
18-3719	Pinion Nut	11-35921	1
18-2343	Washer	12-982721	1
18-2298	Tab Washer	14-18323	1
18-2299	Tab Washer	14-79447	1
18-2206-1	Gear Set	43-42934	1
18-2285	Shim	15-47397A1	1
18-1155	Ball Bearing	30-88957A1	1
18-1158	Needle Roller Bearing	31-30956	1
18-1117	Pinion Bearing	31-42647A1	1
18-1143	Alpha Bearing	31-36387A1	1
18-2294	Shim Kit	15-42637A-1	1
18-2202	Sliding Clutch	52-66063	1



**18-2368**  
**LOWER GEARCASE KIT**  
 Replaces: 43-803071T1  
 ALPHA/GEN II 1996-97



**18-2369**  
**LOWER GEARCASE KIT**  
 Replaces: 43-803069T1  
 ALPHA/GENII 1991-95

**18-2407**  
**GEAR SET**  
 Replaces: 43-878087A4  
 For: MR/Alpha/Gen II  
 lower gear housings



— CONTAINS —

Part #	Description	O.E. #	Qty.
18-2206-1	Gear Set	43-42934	1
18-1155	Ball Bearing	30-88957A1	1
18-1117	Pinion Bearing	31-42647A1	1
18-1158	Needle Roller Bearing	31-30956	1
18-1143	Alpha Bearing	31-36387A1	1
18-2294	Shim Kit	15-42637A-1	1
18-2285	Shim	15-47397	1
18-3719	Pinion Nut	11-35921	1
18-2343	Washer	12-982721	1



**18-2202**  
**SLIDING CLUTCH**  
 Replaces:  
 52-66063,  
 52-853594T  
 888 S/N 3784375 & UP  
 #1 Units S/N 3469428 & UP



**18-2357**  
**CROSS PIN**  
 Replaces:  
 17-30632

PKG. OF 2



**18-2348**  
**18-2348-9<sup>Ⓛ</sup>**  
**CLUTCH CROSS PIN SPRING**  
 Replaces: 24-30893  
 1/MC-1/R/MR/Alpha  
 Mercruiser/Gen II lower  
 S/N D469859-F679999  
 Mercruiser Vazer



**18-2166**  
**PROP SHAFT**  
 Replaces: 44-66060, 44-66060-3, 44-824110, 44-860308  
 For all #1 & MR/ALPHA Units S/N 2791957 & above.  
 Also for 165 (6 cyl.) S/N 2763442 & above.

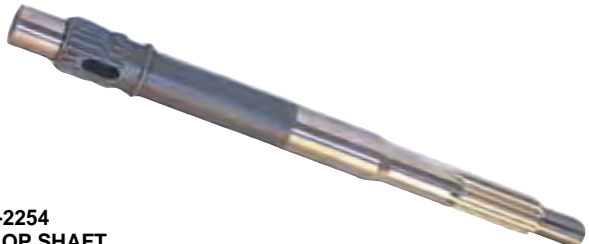

**18-2254**  
**PROP SHAFT**  
 Replaces: 44-850308  
 For: Alpha One Gen II S/N 0L100040 & up/Vazer



**18-2167**  
**DRIVE SHAFT**  
 Replaces: 45-41939A1  
 For all #1 units S/N 2791957 & above except MR/ALPHA Units or units which have been retro-fitted with MR/ALPHA lower units. Also for 165 (6 cyl.) S/N 2763442 & above.



**18-2180**  
**DRIVE SHAFT**  
 Replaces: 45-42634  
 For all MR/ALPHA Units & older units which have been retro-fitted with MR/ALPHA lower units.



**18-2331**  
**DRIVE SHAFT**  
 Replaces: 45-853648  
 For: Ratios 1.47, 1.62, 1.81 & 1.94.  
 Fits: Gen II (1998 & up), (OL100040 & up)  
 For use with: 18-2400 Complete Lower Gear Case



**18-2261**  
**DRIVE SHAFT**  
 Replaces: 45-816919  
 All Alpha I Generation II Drives (with new style 18-3056 Impeller)  
 Serial #D494569 & above.



**18-2346**  
**RETAINER NUT**  
 Replaces: 824519  
 For: MR Alpha & Gen II



**18-3719**  
**PINION NUT**  
 Replaces: 11-35921



**18-2359**  
**DRIVE SHAFT NUT SET**  
 Replaces: 12-92721 & 11-35921  
 Contains:  
 18-3719 Pinion Nut  
 18-2343 Pinion Nut Washer



**18-2286**  
 Replaces: 19755A2

**18-2196**  
 Replaces: 19755A4

**SHIFT SPOOL ASSEMBLIES**

SHIFT SPOOL ASSEMBLY APPLICATION		
Model	Serial #	Part #
1A (EZ-Shift)	1776349 & UP	18-2196
1B (EZ-Shift)	1775193 & UP	18-2196
1C (EZ-Shift)	1777799 & UP	18-2196
120/140	2062141-3780849	18-2196
120/140	3780850 & UP	18-2286
160	2065190-2763441	18-2196
165	2763442-3780849	18-2196
165	3780850 & UP	18-2286
888	3106717-3784374	18-2196
888	3784375 & UP	18-2286
898/228	4782330 & UP	18-2286
225-S	3856268-4200499	18-2286
233	4200500 & UP	18-2286
470/485	4208730 & UP	18-2286
R/MR/Alpha One	6225377 & UP	18-2286
Alpha One (Gen II)	D494569 & UP	18-2286



**18-3759**  
**THRUST BEARING RING**  
 Replaces: 35915



**18-2342**  
**THRUST RING**  
 Replaces: 681001  
 For: MR/ ALPHA



**18-2191**  
**CARRIER BEARING**  
 Replaces: 73020A14  
 For: #1R/MR/Alpha I  
 For: Housings with casting #73020C

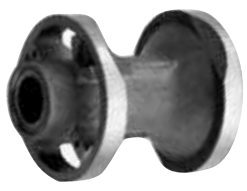

**18-2376**  
**CARRIER BEARING**  
 Replaces: 818763A10  
 For: Alpha Gen II & MR Units  
 For: Housings with casting #73020C1, Mercruiser Vazer



**18-2150**  
**SHIFT SHAFT**  
 Replaces: 774811  
 Stainless Steel



**18-2353**  
**SHIFT ROD BUSHING ASSEMBLY**  
 Replaces: 23-815921A21



**18-2154**  
**SHIFT SHAFT HOUSING BUSHING**  
 Replaces: 23-30617A2  
 Mercruiser & Alpha 1 (S/N 1684188 & UP)



**18-3198**  
**WATER PICK-UP**  
 Port  
 Replaces: 934241  
 For: MR Alpha



**18-3199**  
**WATER PICK-UP**  
 Starboard  
 Replaces: 934231  
 For: MR Alpha



**18-2320**  
**SHIFT SHAFT**  
 Replaces: 815919A1  
 For: Gen II



**18-2130**  
**SHIFT CRANK**  
 Replaces: 76865  
 For All #1 Units R/MR/Alpha,  
 Mercruiser Vazer

PKG. OF 2



**18-4295**  
**18-4295-9<sup>①</sup>**  
**E-CLIP**  
 Replaces: 53-29641  
 For: Gen II



**18-2299**  
**TAB WASHER**  
 Replaces: 14-79447



**18-2298**  
**TAB WASHER**  
 Replaces: 14-18323



**18-3751**  
**SPANNER NUT**  
 Replaces: 79448  
 For: Mercruiser Vazer



**18-2354**  
**CARRIER SEAL**  
 Replaces: 821759A4

PKG. OF 2



**18-2707**  
**18-2707-9<sup>①</sup>**  
**COLLAR KEEPER**  
 Replaces: 97351  
 For: Bravo



**18-1117**  
**PINION BEARING**  
 Replaces: 31-42647A1



**18-1356**  
**PINION BEARING**  
 Replaces: 31-54928



**18-1142**  
**UPPER PINION BEARING**  
 Replaces: 31-32573A1

Model	Year	Model	Year
215 E/H	1970-72	II, TR	1973-76
225TRS, 280 TRS	1973-76	TR, TRS	1977-93

<sup>①</sup> Priced per Package





**18-1193  
TAPERED  
ROLLER BEARING**  
Replaces: 31-33138A1  
Fits: Gen II (1998-Up), Mercruiser Vazer



**18-1143  
TAPERED  
ROLLER BEARING**  
Replaces: 31-36387A1



**18-1156  
FORWARD  
GEAR BEARING**  
Replaces: 31-30894A1  
For: Mercruiser Vazer



**18-1161  
TAPERED  
ROLLER BEARING**  
Replaces: 31-35990A1  
For: Mercruiser Vazer



**18-1162  
TAPERED  
ROLLER BEARING**  
Replaces: 31-38356A1



**18-1164  
TAPERED  
ROLLER BEARING**  
Replaces: 31-53079A1



**18-1165  
TAPERED  
ROLLER BEARING**  
Replaces: 31-61100A1



**18-1173  
TAPERED  
ROLLER BEARING**  
Replaces: 31-828437A2



**18-1179  
TAPERED  
ROLLER BEARING**  
Replaces: 31-32575A1, T1  
For: Gen II F680000 & UP,  
Mercruiser Vazer



**18-1127  
TAPERED  
ROLLER BEARING**  
Replaces: 31-54038A1  
For: Bravo II - Lower (S/N B664190 & UP)



**18-1182  
ROLLER BEARING KIT**  
Replaces: 31-30894A5  
For: Alpha I (Gen II) (1998 & up)  
(OL100040 & up), Mercruiser Vazer



**18-1197  
TAPERED FORWARD  
GEAR BEARING**  
Replaces: 31-828439A2  
For: Alpha I (Gen II) (1996-97)  
(OF680000-OK999999)



**18-1129  
UPPER DRIVE  
SHAFT BEARING**  
Replaces: 31-86748A1  
For: Bravo I, II, III - Lower  
(S/N B664190 & UP)



**18-1150  
NEEDLE ROLLER BEARING**  
Replaces: 31-92366A1



**18-1157  
FORWARD GEAR  
INNER BEARING**  
Replaces: 31-30895,  
31-30895T  
For: Mercruiser Vazer



**18-1158  
CARRIER BEARING**  
Replaces: 31-30956,T  
For: Mercruiser Vazer



**18-1153  
BALL BEARING**  
Replaces:  
30-63326, 30-63326T



**18-1155**  
**BALL BEARING**  
 Replaces: 30-88957A1, T



**18-1160**  
**DRIVE BEARING KIT**  
 Replaces: 31-35988A2, 31-35988A12

**MERCURISER STERNDRIVE UPPER GEAR HOUSING BEARINGS**

Sterndrive Model	Drive Ratio	Years	Serial Number	Drive Gear (Yoke)	Driven Gear	Upper Cap
IA,IB,IC & EZ Shift	All	1964-66	1684188 - 2065186	18-1160	18-1161	18-1179
120/140	1.98	1967	2062141 - 2187468	18-1160	18-1161	18-1161
120/140	1.98	1967-71	2187469 - 3134193	18-1160	18-1161	18-1179
120/140	1.98	1971-82	3134194 - 6225576	18-1160	18-1161	18-1165
470/485	1.84	1976-82	4208730 - 6225576	18-1160	18-1161	18-1165
160	1.68	1967	2065190 - 2182197	18-1160	18-1161	18-1161
160	1.68	1967-71	2182198 - 3134193	18-1160	18-1161	18-1179
165	1.65	1971-81	3213658 - UP	18-1160	18-1161	18-1165
888	1.5	1971-73	3106717 - 3134193	18-1160	18-1161	—
888	1.5	1973-77	3134194 - UP	18-1160	18-1161	18-1165
225-S	1.5	1974	3856268 - 4200499	18-1160	18-1161	18-1165
898/228	1.65	1977-82	4782330 - 6225576	18-1160	18-1161	18-1165
233	1.32	1975-77	4200500 - UP	—	—	18-1165
250	1.32	1977	4791300 - 4898729	—	—	18-1165
255-TRS	All	1973-74	3377316 - 4203749	18-1162 ③	18-1162	—
260	1.5	1978-82	4898730 - 6225576	18-1160	18-1161	18-1165
280-TRS	All	1975-76	4203750 - 4895399	18-1162 ③	18-1162	—
R/MR/Alpha One	1.98/1.84/ 1.65/1.50	1984-90	6225577 - UP	18-1160	18-1161 ① ④	18-1165
R/MR/Alpha One	1.5	1984-90	6225577 - UP	18-1160	18-1142	18-1165
R/MR/Alpha One	1.32	1984-90	6225577 - UP	—	—	18-1165
R/MR/Alpha One	1.5 Heavy Duty	1984-90	6225577 - UP	—	18-1142	18-1165
Alpha One SS	1.32	1986-89	A545004 - UP	—	—	18-1165
Alpha One SS	1.5	1986-89	A545004 - UP	—	18-1142	18-1165
Alpha One Gen II	2.40/1.98/ 1.84/1.65	1991-95	D469859 - F679999	18-1160	18-1161 ④	18-1165
Alpha One Gen II	1.5	1991-95	D469859 - F679999	18-1160	18-1142	18-1165
Alpha One Gen II	2.40/1.94/ 1.81/1.62	1996-97	F680000 - K999999	18-1160	18-1161 ④	18-1179
Alpha One Gen II	1.47	1996-97	F680000 - K999999	18-1160	18-1142	18-1179
Alpha One Gen II	2.40/2.00/ 1.94/1.81/ 1.62	1998 & Up	L100040 - UP	—	18-1161	18-1179
Alpha One Gen II	1.47	1998 & Up	L100040 - UP	—	18-1142	18-1179
II-TR	—	1973-76	3377316 - 4794899	18-1162 ②	18-1162	—
SSM II	—	1982-97	ALL	18-1162 ③	18-1162	—
TR/TRS	—	1977-93	4794900 - UP	18-1162 ③	18-1162	—
Bravo I, II, III	All	—	B664190 & UP	—	—	18-1129

① Timken Cone # 89449 / Cup 89410  
 ② Straight Shoulder Gear Only

③ Bearing for U-Joint Yoke  
 ④ Use 18-1142 for 1.5:1 Upper Gear Ratio

**MERCUISER STERNDRIVE LOWER GEAR HOUSING BEARINGS**

Sterndrive Model	Years	Beg. S/N - End. S/N	Prop Bearing Carrier	Lower Drive Shaft (Pinion)	Upper Drive Shaft	Inside Forward Gear (Needle)	Outside Forward Gear	Reverse Gear
60	1965-66	1830753 - 2063740	—	—	—	—	18-1162	—
80/90	1966-72	2063741 - 3225967	18-1158	—	—	18-1157	18-1156	—
I	1963	1534570 - 1536617	18-1158	—	18-1153	18-1157	18-1156	—
I	1963	1536618 - 1684187	18-1158	—	—	18-1157	18-1156	—
IA,IB,IC & EZ Shift	1964-66	1684188 - 2065189	18-1158	—	—	18-1157	18-1159	18-1155
120/140	1967-69	2062141 - 2791956	18-1158	—	18-1164 ④	18-1157	18-1159	18-1155
120/140	1970-77	2791957 - 4893634	18-1158	—	18-1164	18-1157	18-1159	18-1155
120/140	1978-82	4893635 - 6225576	18-1158	18-1150	18-1164	18-1157	18-1159	18-1155
470	1976-77	4208730 - 4893934	18-1158	—	18-1164	18-1157	18-1159	18-1155
470/485	1978-82	4893835 - 6225576	18-1158	18-1150	18-1164	18-1157	18-1159	18-1155
160	1967-69	2065190 - 2763441	18-1158	—	18-1164 ④	18-1157	18-1159	18-1155
165	1970-77	2763442 - 4890459	18-1158	—	18-1164	18-1157	18-1159	18-1155
165	1978-81	4890460 - UP	18-1158	18-1150	18-1164	18-1157	18-1159	18-1155
888	1971-77	3106717 - UP	18-1158	—	18-1164	18-1157	18-1159	18-1155
225/233	1974-77	3856268 - UP	18-1158	—	18-1164	18-1157	18-1159	18-1155
898/228	1977	4782330 - 4898729	18-1158	—	18-1164	18-1157	18-1159	18-1155
898/228	1978-82	4898730 - 6225576	18-1158	18-1150	18-1164	18-1157	18-1159	18-1155
250	1977	4791300 - 4898729	18-1158	—	18-1164	18-1157	18-1159	18-1155
255-TRS	1973-74	3377316 - 4203749	18-1158	—	—	—	18-1159	N/A
260	1978-82	4898730 - 6225576	18-1158	18-1150	18-1164	18-1157	18-1159	18-1155
280-TRS	1975-76	4203750 - 4895399	18-1158	—	—	—	18-1159	N/A
R	1983	6225577 - UP	18-1158	18-1150	18-1164	18-1157	18-1159	18-1155
MR / Alpha One	1984-90	6225577 - UP	18-1158	18-1117	18-1143	—	18-1159 ⑤	18-1155
MR / Alpha One	1984-90	6225577 - UP	18-1158	18-1117	18-1143	18-1157 ②	18-1159 ⑤	18-1155
MR / Alpha One (CR)	1984-90	6225577 - UP	18-1158	18-1117	18-1143	—	—	—
Alpha One SS	1986-89	A545004 - UP	18-1158	18-1117	18-1143	18-1157	18-1159	18-1155
Alpha One Gen II	1991-95	D469859 - F679999	18-1158	18-1117	18-1143	18-1157	18-1159 ⑤	18-1155
Alpha One Gen II (CR)	1991-95	D469859 - F679999	18-1158	18-1117	18-1143	—	—	—
Alpha One Gen II	1996-97	F680000 - K999999	18-1158	18-1117	18-1143	18-1157	18-1156	18-1155
Alpha One Gen II (CR)	1996-97	F680000 - K999999	18-1158	18-1117	18-1143	—	—	—
Alpha One Gen II	1998-newer	L100040 - UP	18-1158	18-1117	18-1143	18-1157	18-1156 ③	18-1155
Alpha One Gen II (CR)	1998-newer	L100040 - UP	18-1158	18-1117	18-1143	—	—	—
II	1962-67	1474909 - 2275488	—	—	—	N/A	18-1156 ③	N/A
II ③	1968-69	2398798 - 2671321	—	—	—	—	18-1162	18-1156
II-TR	1973-76	3377316 - 4794899	—	—	18-1161 ①	—	—	N/A
TR	1973-93	4794900 - UP	—	—	18-1161 ①	—	—	N/A
TRS	1973-93	4794900 - UP	18-1158	—	—	—	18-1159	N/A

① 18-1161 Top Bearing /  
18-1163 Bottom Bearing

② Torrington#B1616  
③ Prop Shaft Drive Gear

④ #15520 Stamped on Cup  
⑤ Use 18-1173 for 2.40:1 ratio only (new style lower gears) our **18-2206-1**



**18-2349**  
**SHIFT SHAFT SLEEVE**  
 Replaces: 23-67370



Display Package

**18-2244**  
**18-22441-9<sup>①</sup>**  
 (PKG. OF 50 WITHOUT GASKET)  
**DRAIN PLUG**  
 Replaces: 10-79953A2  
 For: #1/R/MR/Alpha/Alpha I Gen II  
 Both Upper And Lower Units



② **18-2375D** Display Package

**18-2375**  
**18-23751-9<sup>①</sup>**  
 (PKG. OF 50 WITHOUT GASKET)  
**DRAIN PLUG MAGNET**  
 Replaces: 10-14834A1, 22-67892A1  
 (Magnet)  
 For: Alpha MR/Gen II lower units  
**Not to be used on #1/R lower units**



**18-2165**  
**CONTROL BOX CAM**  
 Replaces: 59369



**18-4220**  
**THRUST WASHER**  
 Replaces: 13171, 77987  
 V-6, Outboards &  
 Mercruiser Sterndrives



**18-3784**  
**THRUST WASHER**  
 Replaces: 805100  
 Fits: Bravo III (Front)



② **18-3701D** Display Package

**18-3701**  
**PROP NUT KIT**  
 Replaces: 11-52707A1  
 —CONTAINS—

Part #	O.E. #	Description
18-3200	14-31210, 14-816629	Tab Washer
18-3700	11-52707	Prop Nut



**18-3755**  
**PROP NUT KIT**  
 Fits: Bravo III (Front)



**18-3756**  
**PROP NUT KIT**  
 Fits: Bravo III (Rear)

PKG. OF 10



**18-3200**  
**18-3200-9<sup>①</sup>**  
**TAB WASHER**  
 Replaces: 14-31210, 14-816629



**18-3787**  
**TAB WASHER**  
 Replaces: 805101T  
 Fits: Bravo III (Rear)

PKG. OF 10



**18-3788-9<sup>①</sup>**  
**TAB WASHER**  
 Replaces: 14-34817  
 Fits: Bravo II



**18-3783**  
**PROP NUT**  
 Replaces: 11-859131  
 Fits: Bravo III (Front)



**18-3785**  
**PROP NUT**  
 Replaces: 11-826711 27  
 Fits: Bravo II



**18-3786**  
**PROP NUT**  
 Replaces: 11-862907  
 Fits: Bravo III (Rear)

① Priced per Package

② Items ending in "D" are Display Packaged - Regular number is Non-Display



**18-3700  
PROP NUT**  
Replaces: 11-52707



**18-3714  
BRASS CASTLE WASHER**  
Replaces: 12-31211A2  
Fits: Alpha/Bravo I (without Flo-Torq II Hub)  
NOTE: Fits above product with rubber hub propellers (non-Flo-Torq II)

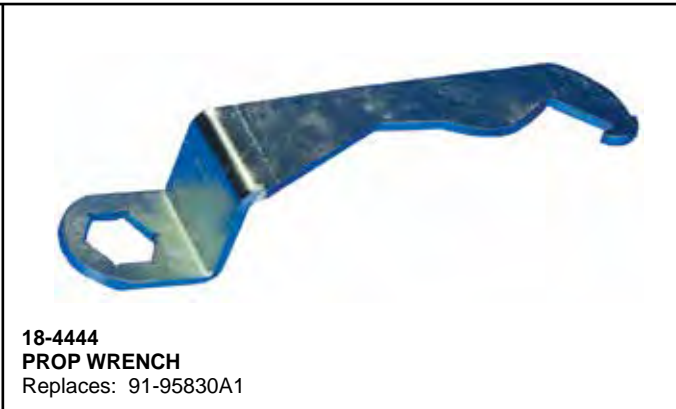

**18-4444  
PROP WRENCH**  
Replaces: 91-95830A1



**18-4459  
PROP WRENCH**  
Replaces: 91-821887A-1,  
91-859046Q4



**18-4446  
PROP WRENCH KIT**

—CONTAINS—

Part #	O.E. #	Description
18-3200	14-31210, 14-816629	Tab Washer
18-3700	11-52707	Prop Nut
18-4444	91-95830A1	Prop Wrench

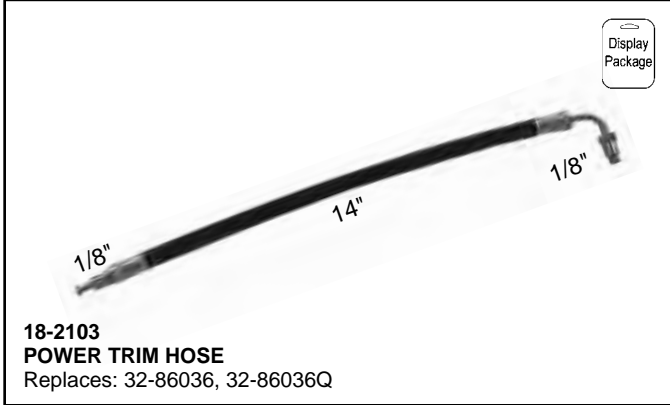

**18-2103  
POWER TRIM HOSE**  
Replaces: 32-86036, 32-86036Q

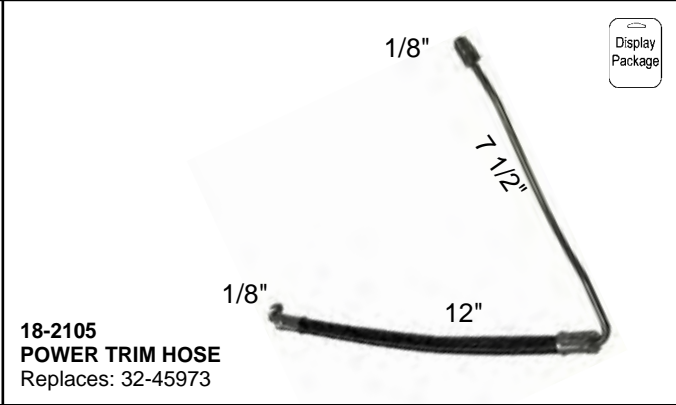

**18-2105  
POWER TRIM HOSE**  
Replaces: 32-45973

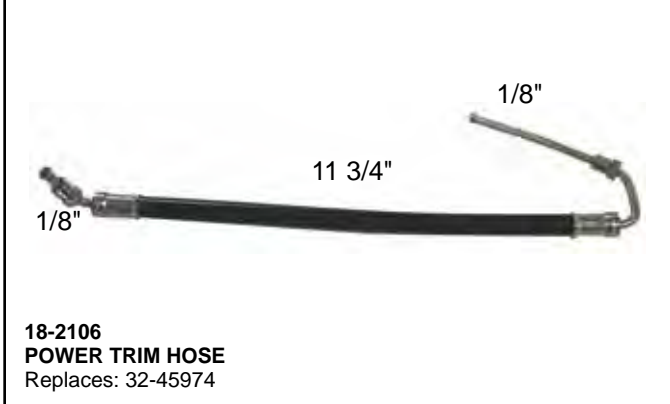

**18-2106  
POWER TRIM HOSE**  
Replaces: 32-45974

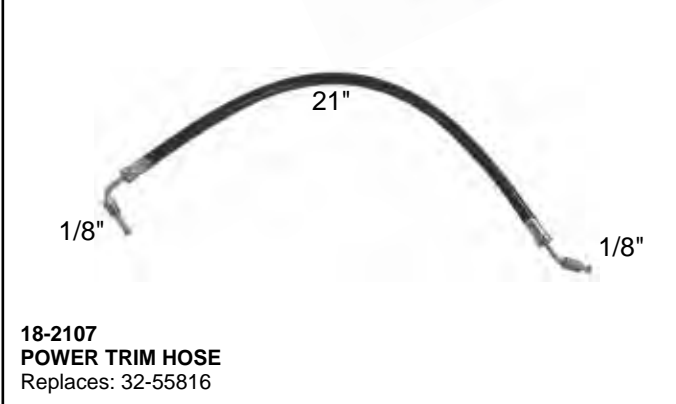

**18-2107  
POWER TRIM HOSE**  
Replaces: 32-55816

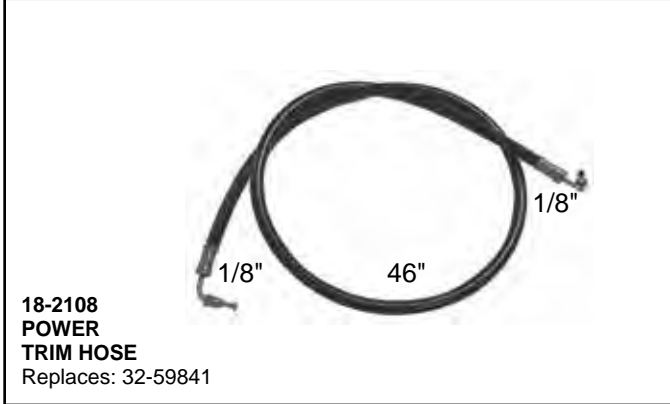

**18-2108  
POWER TRIM HOSE**  
Replaces: 32-59841



**18-2109  
POWER TRIM HOSE**  
Replaces: 32-59842

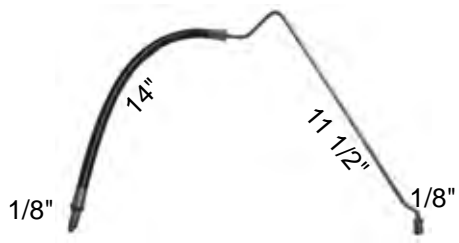

**POWER TRIM HOSE**  
Starboard  
Connector to bottom of trim cylinder MCM 120-260 & BRAVO

Part #	O.E. #	Description
18-2114	32-99902-1, 32-864960	Trim Cyl. Casting #14034-1
18-2136*	32-99902, 32-864589	Trim Cyl. Casting #98704, 98704-1

\* Approximately 11 1/4" long

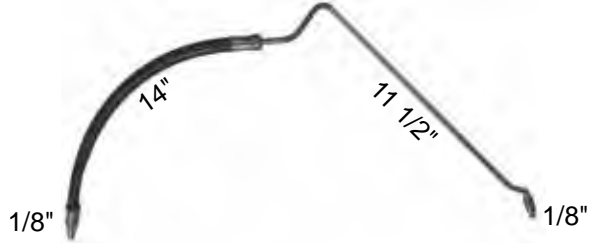

**POWER TRIM HOSE**  
Starboard  
Connector to bottom of trim cylinder MCM 120-260 & BRAVO

Part #	O.E. #	Description
18-2115	32-99903-1, 32-864959	Trim Cyl. Casting #14035-1
18-2137*	32-99903, 32-864588	Trim Cyl. Casting #98703, 98703-1

\* Approximately 11 1/4" long

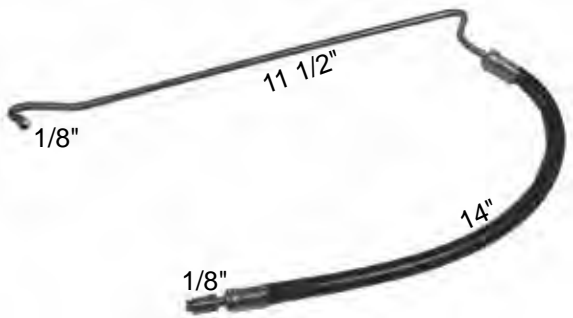

**18-2112**  
**POWER TRIM HOSE**  
Replaces: 32-87234

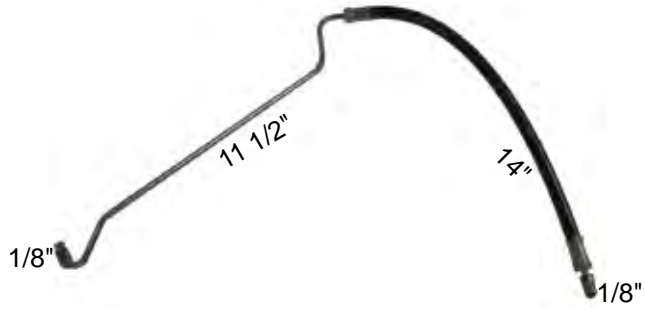

**18-2113**  
**POWER TRIM HOSE**  
Replaces: 32-87235



**18-2435**  
**POWER TRIM HOSE**  
Replaces: 32-861127, 32-95858  
Fits R/MR/Alpha/Alpha Gen II/Bravo I, II, III/Bravo X, XR, XZ  
Serial number 0W099999 and below without quick connect fittings.  
OEM hose color is black.



**18-2436**  
**POWER TRIM HOSE**  
Replaces: 32-861128, 32-95859  
Fits R/MR/Alpha/Alpha Gen II/Bravo I, II, III/Bravo X, XR, XZ  
Serial number 0W099999 and below without quick connect fittings.  
OEM hose color is gray.



**18-2116**  
**POWER TRIM HOSE**  
Replaces: 32-99904



**18-2126**  
**POWER TRIM HOSE**  
Replaces: 32-52951A1

# POWER TRIM HOSE APPLICATION

Stern Drive Model	Years	Serial No.	Trim Cylinder to Connector (port down)	Trim Cylinder to Connector (port up)	Trim Cylinder to Connector (stbd down)	Trim Cylinder to Connector (stbd up)	Pump to Hydraulic Connector	Pump to Hydraulic Connector	Connector to Reverse Lock Valve	Hydraulic Pump & Reverse Lock Valve
120, 140	1967-69	2062141 - 2791956	—	18-2106	—	18-2105	—	N/A	—	18-2126
120, 140	1970-73	2791957 - 3780849	18-2103	18-2103	18-2103	18-2103	18-2107	N/A	—	18-2126
120, 140	1974-82	4893635 - 6225576	18-2103	18-2103	18-2103	18-2103	18-2107	N/A	18-2109	18-2126
470/485	1976-82	4208730 - 6225576	18-2103	18-2103	18-2103	18-2103	18-2107	N/A	18-2109	18-2126
160	1967-69	2065190 - 2763441	—	18-2106	—	18-2105	—	N/A	—	18-2126
165	1970-73	2763442 - 3780849	18-2103	18-2103	18-2103	18-2103	18-2107	N/A	—	18-2126
165	1974-81	3780850 & UP	18-2103	18-2103	18-2103	18-2103	18-2107	N/A	18-2109	18-2126
888	1974 & UP	3106717 & UP	18-2103	18-2103	18-2103	18-2103	18-2108	N/A	18-2109	—
225/233	1974-77	3856268 & UP	18-2103	18-2103	18-2103	18-2103	18-2108	N/A	18-2109	—
228/898/250/260	1977-82	4782330 - 6225576	18-2103	18-2103	18-2103	18-2103	18-2108	N/A	18-2109	—
R/MR/Alpha/SS	1983-90	6225577 & UP	18-2137 ③	18-2116	18-2136 ③	18-2116	18-2436⑤	18-2435⑤	N/A	N/A
R/MR/Alpha/SS	1983-90	6225577 & UP	18-2115 ④	18-2116	18-2114 ④	18-2116	18-2436⑤	18-2435⑤	N/A	N/A
Alpha One GEN II	1991-97	D469859 & UP	18-2115	18-2116	18-2114	18-2116	18-2436⑤	18-2435⑤	N/A	N/A
Alpha One GEN II ⑥	1998 & UP	0L100040 & UP	18-2115	18-2116	18-2114	18-2435	18-2436⑤	18-2435⑤	N/A	N/A
Bravo I,II & III ⑥	1988 & UP	B664190 & UP	18-2137	18-2116	18-2136	18-2116	18-2436⑤	18-2435⑤	N/A	N/A
Blackhawk	1994-95	F186717 & UP	18-2137	18-2116	18-2136	18-2116	18-2436⑤	18-2435⑤	N/A	N/A
II (1.78)	1968-69	2398798 - 2671321	18-2103	18-2103	18-2103	18-2103	—	N/A	—	18-2126
III	1968-72	2373127 - 3002613	18-2103	18-2103	18-2103	18-2103	—	N/A	—	—
215E/H	1970-72	2909035 - 2915034	18-2103	18-2103	18-2103	18-2103	—	N/A	—	—
TR/TRS	1973-93	3377316 & Up	18-2103 ②	18-2103	18-2103 ②	18-2103	—	N/A	—	—
TR/TRS	1973-93	3377316 & Up	18-2103 ②	18-2103	18-2103 ②	18-2103	—	N/A	—	—
TR/TRS	1973-93	3377316 & Up	— ①	18-2103	— ①	18-2103	—	N/A	—	—

- ① 90° hose end
- ② External trim lines
- ③ Internal cylinder lines
- ④ Oildyne pump
- ⑤ 18-2436 OEM hose color is gray, 18-2435 OEM hose color is black
- ⑥ Serial number 0W099999 and below without quick connect fittings.

- ★ High quality EPDM rubber cups
- ★ Metal hose connector complete with rubber washer
- ★ Use with a standard garden hose
- ★ Corrosion resistant dicromate finish
- ★ Installs in seconds
- ★ No tools required



**18-9010**  
**MOTOR FLUSHER**  
 Heavy Duty  
 Replaces: 73971A2, 44357A2, Q2

Flushes cooling system of salts and sediments and allows engine to idle for tuning and engine adjustment in your own driveway. Simply slip attachment over the engine's side water intakes. Coated spring steel arms clamp suction cup securely over the engine's side water intakes.

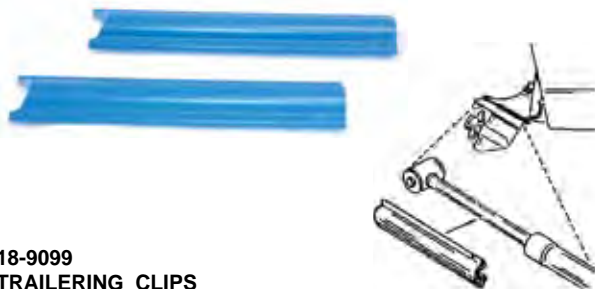

**18-9099**  
**TRAILERING CLIPS**  
 Replaces: 817019A1, 817019Q2  
 For all ALPHA I, ALPHA Generation II, Bravo I, II, III, and Blackhawk

**STAINLESS STEEL LOCKNUTS**

Part #	O.E. #	Thread Size
18-3720 ③	11-34932	3/8" - 24
18-3721 ① ③	11-34933	7/16" - 20
18-3722 ② ③	11-35888, 11-20361	1/4" - 28
18-3723 ③	11-45592	5/16" - 24

① PKG OF 6    ② PKG OF 5

**18-2372**  
**TRIM CYLINDER END CAP**  
 Replaces: 88035  
 1.850 Cap Diameter  
 For: R/MR/Alpha

**18-2373**  
**TRIM CYLINDER END CAP**  
 Replaces: 806191T  
 1.890 Cap Diameter  
 For: R/MR/Alpha/ Gen II/Bravo

**18-2465-9④**  
**PIVOT PIN END CAP**  
 Replaces: 19-14842  
 For: R/MR/Alpha One (1983-90)  
 Serial No. 6225577 and up  
 I/II/III (1988-02) Serial No. 6225577

**18-2466-9④**  
**PIVOT PIN END CAP**  
 Replaces: 19-815951  
 For: Alpha One Gen II (1991-02)  
 Serial No. OD469859 and up

**18-2461**  
**TRIM CYLINDER ANCHOR PIN KIT**  
 Replaces: 17-44166T1  
 For: Bravo I/II/III (1988-02)  
 Serial No. 6225577 and up

**18-2462**  
**TRIM CYLINDER ANCHOR PIN KIT**  
 Replaces: 17-14873A1  
 For: R/MR/Alpha One (1983-90)  
 Serial No. 6225577 and up (Front)

③ This product is priced per piece. To order priced per package, please add -9 to the part number.  
 ④ Priced per package



**18-2463**  
**TRIM CYLINDER ANCHOR PIN KIT**  
 Replaces: 17-14872A1  
 For: R/MR/Alpha One (1983-90)  
 Serial No. 6225577 and up (Rear)



**18-2464**  
**FRONT AND REAR ANCHOR PIN KIT**  
 Replaces: 17-815953T1, 56-864641A24  
 For: All Alpha One Gen II



**18-7633**  
**TRIM SENDER/LIMIT KIT**  
 Replaces: 805320A03  
 Fits: MC-I, R, MR, Alpha, Alpha Gen II, Bravo drives



**18-2142**  
**POWER TRIM CYLINDER**  
 Replaces: 45706A14  
 Fits All Stern Drive Models with internal lines: 120, 140, 160, 165, 888, 898, 228, 225-S, 233, 250, 260,470 & 485



**18-2148**  
**POWER TRIM CYLINDER HOUSING**  
 Replaces: 77442A1  
 Fits All Stern Drive Models: 120, 140, 160, 165, 888, 898, 228, 225-S, 233, 250, 260,470 & 485



**18-2420**  
**POWER TRIM CYLINDER**  
 Replaces: 14034A3  
 For: R/MR/ALPHA (Starboard)



**18-2421**  
**POWER TRIM CYLINDER**  
 Replaces: 14035A3  
 For: R/MR/ALPHA (Port)



**18-2422**  
**POWER TRIM CYLINDER**  
 Replaces: 815935A7  
 For: GEN II (Port) (S/N F680000 - UP)



**18-2423**  
**POWER TRIM CYLINDER**  
 Replaces: 81595A7  
 For: GEN II (Starboard)  
 (S/N F680000 - UP)



**18-2424**  
**POWER TRIM CYLINDER**  
 Replaces: 98703A26  
 For: BRAVO (Port)



**18-2425**  
**POWER TRIM CYLINDER**  
 Replaces: 98704A17, 98704A26  
 For: BRAVO (Starboard)



**18-2426**  
**POWER TRIM CYLINDER**  
 Replaces: 98703A3  
 For: R/MR/ALPHA (Port)



**18-2427**  
**POWER TRIM CYLINDER**  
 Replaces: 98704A3  
 For: R/MR/ALPHA (Starboard)



**18-2649**  
**POWER TRIM SEAL KIT**  
 Replaces: 25-87400A2



**18-2291**  
**TRIM CYLINDER REPAIR KIT**  
 Replaces: 25-60342A2  
 Fits All Stern Drive Models: 120, 140, 160, 165, 888, 898, 228, 225-S, 233, 250, 260,470 & 485



**18-2428**  
**TRIM CYLINDER REPAIR KIT**  
 Replaces: 87399A2  
 For: R/MR/ALPHA I, BRAVO



**18-2429**  
**TRIM CYLINDER REPAIR KIT**  
 Replaces: 87399A3  
 For: ALPHA I GEN II



**POWER TRIM CYLINDER APPLICATION**

Model	Year	Serial Number	Trim Cylinder Port	Trim Cylinder Starboard	Housing Port	Housing Starboard	Trim Cylinder Seal Kit
120/ 140 4cyl, 160 6 cyl	1967- 69	2062141- 2791956	18-2142	18-2142	—	—	—
All #1 Drives ①	1970- 82	2791957- 6225576	18-2142	18-2142	18-2148	18-2148	18-2291
R/ MR/ ALPHA I	1983-90	6225577 & UP	18-2426 ②	18-2427 ②	—	—	18-2649
ALPHA I SS	1986- 89	0A545004 & UP	18-2426 ②	18-2427 ②	—	—	18-2649
R/ MR/ ALPHA I	1983-90	6225577 & UP	18-2421 ③	18-2420 ③	—	—	18-2649
ALPHA I SS	1986- 89	0A545004 & UP	18-2421 ③	18-2420 ③	—	—	18-2649
ALPHA I GEN II	1991-2001	0D469859 & UP	18-2422	18-2423	—	—	18-2649
BRAVO I/ II/ III	1988 & UP	0B664190 & UP	18-2424	18-2425	—	—	18-2649
BLACKHAWK	1994-95	0F186717 & UP	18-2424	18-2425	—	—	18-2649

① Excludes the TR, TRS, 215E, H and early II & III drives ② With 15 9/16" long trim cylinder tube ③ With 16 3/16" long trim cylinder tube

<p>PKG. OF 5</p>  <p><b>18-4252</b> <b>18-4252-9⑦</b> <b>CONTINUITY SPRING</b> Replaces: 24-46312 Grounds the trim cylinder to the pivot pin shaft.</p>	 <p><b>18-2151</b> 7 1/2" (Front) Replaces: 17-45738</p> <p><b>18-2152</b> 10 1/2"(Rear) Replaces: 17-45735</p> <p><b>PIVOT PIN</b> Used on 120, 120-260, 140,165, 225S, 233, 250, 470, 888, 898/228 Use 18-2701 Bushing</p>	 <p><b>18-2393</b> <b>TRIM CYLINDER PIVOT PIN</b> For: Trim cylinder rear R/MR/Alpha Use: 18-2702-1 Bushing</p>	 <p><b>18-2394</b> <b>TRIM CYLINDER PIVOT PIN</b> For: Trim cylinder front R/MR/Alpha Use: 18-2702-1 Bushing</p>
 <p><b>18-2395</b> <b>TRIM CYLINDER PIVOT PIN</b> Replaces: 17-815953 For: Trim cylinder front &amp; rear Gen II</p>	 <p><b>18-2396</b> <b>TRIM CYLINDER PIVOT PIN</b> Replaces: 17-44166 For: Rear Bravo</p>	 <p><b>18-2397</b> <b>TRIM CYLINDER PIVOT PIN</b> Replaces: 17-44167A1 For: Front Bravo</p>	
 <p><b>POWER TRIM BUSHING</b> 18-2701⑤ 18-2701-04⑥ 18-2701-9④ Replaces: 23-89574 Fits 120/260 Drive Units (S/N 6225276 &amp; Down)</p>	 <p><b>POWER TRIM BUSHING</b> 18-2702-1⑤ 18-2702-04⑥ 18-2702-1-9④ Replaces: 23-99291, 23-99291T Fits 120/260 Drive Units (S/N 6225277 &amp; UP)</p>	<p>PKG. OF 8</p>  <p><b>18-4288</b> <b>18-4288-9⑦</b> <b>POWER TRIM BUSHING</b> Replaces: 23-807073 For: Bravo</p>	<p>PKG OF 2</p>  <p><b>18-2345</b> <b>18-2345-9⑦</b> <b>TRIM CYLINDER ANCHOR PIN E-RING</b> Replaces: 53-815949 For: Gen II</p>
<p>PKG. OF 2</p>  <p><b>18-4289</b> <b>18-4289-9⑦</b> <b>RETAINING RING</b> Replaces: 53-805272 For: Bravo</p>	<p>PKG. OF 4</p>  <p><b>18-2336</b> <b>18-2336-9⑦</b> <b>TRIM BUSHING</b> Replaces: 23-90203 For: TR &amp; TRS(1977-93),Alpha One SS (1986-1989) , SSM(1982-1995)</p>	<p>PKG. OF 8</p>  <p><b>18-2341-1</b> <b>18-2341-1-9⑦</b> <b>POWER TRIM BUSHING</b> Replaces: 23-815950, 23-8159501 For: Gen II</p>	<p>PKG OF 5</p>  <p><b>18-3232</b> <b>18-3232-9⑦</b> <b>PLUG</b> Replaces: 19-47579 For: MR Alpha</p>

④ Standard package of 8 priced per piece  
⑤ Standard package of 8 priced per package  
⑥ Priced per Package of 4  
⑦ Priced per Package

Zinc is for saltwater only applications.  
 Magnesium is for fresh water only applications.  
 Aluminum is for brackish water or salt water environments.

**18-6154A**  
**18-6154M**  
**18-6154Z**  
**ANODE KIT**  
 Bravo III (2004 and Newer)

**18-6158M**  
**18-6158Z**  
**18-6158A**  
**ANODE KIT**  
 Replaces:  
 888755Q01 (18-6158M),  
 888756Q01 (18-6158A)  
 Mercuriser Alpha I Gen II (1991 & UP)

**18-6159A**  
**18-6159M**  
**18-6159Z**  
**ANODE KIT**  
 Replaces:  
 888758Q01 (18-6159A),  
 888757Q01 (18-6159M)  
 Mercuriser Bravo I - All Years

**18-6160A**  
**18-6160M**  
**18-6160Z**  
**ANODE KIT**  
 Replaces:  
 888761Q01 (18-6160A),  
 888760Q01 (18-6160M)  
 Bravo II (1989 & Up), Bravo III (1989-03)

① **18-6117A**  
 ② **18-6117M**  
 ③ **18-6117Z**  
**ANODE**  
 Replaces:  
 Mercuriser 806188A1, A2  
 For: Bravo One bearing carrier

② **18-6241**  
 ③ **18-6011**  
 ① **18-6011A**  
**ANODE**  
 Replaces: 31640, A1, Q4, T6  
 For use on R/MR/Alpha One, Sterndrive &  
 Transom Assembly (1983-90) & prior drives,  
 Alpha One, Gen II (1991 & up)

③ **18-6012**  
**ANODE**  
 Replaces: 34127A1, T2  
 For use on R/MR/Alpha One (Sterndrive &  
 Transom Assembly 1983-90) & prior drives

③ **18-6013**  
**ANODE**  
 Replaces: 34762A1  
 For use on Alpha One SS (Sterndrive &  
 Transom Assembly 1983-89) & prior drives

③ **18-6014**  
 ① **18-6014A**  
**ANODE**  
 Replaces:  
 46399A1, 822777A1, Q1  
 For use on Alpha One SS (1982-89)

**PKG OF 2**  
 ⑥③ **18-6015-9**  
 ③⑤ **18-60151-9**  
 ⑥① **18-6015A-9**  
 ⑥② **18-6242-9**  
**ANODE**  
 Replaces: 55989A3, Q9, T9  
 Bravo I, II, III (1988-95)

③ **18-6016**  
 ③④ **18-60161**  
 ③⑤ **18-60161-9**  
 ① **18-6016A**  
 ② **18-6244**  
**ANODE**  
 Replaces: 76214, T3, Q5  
 200, 225, 250HP, V-155-V-200, & All  
 Bravos, Alpha One, Gen II (1991 & up)

③ **18-6066**  
 ① **18-6066A**  
 ② **18-6243**  
**ANODE**  
 Replaces: 43994A2, 821631Q1  
 For use on R/MR/Alpha One (Sterndrive  
 & Transom Assembly 1983-90)

① Aluminum    ② Magnesium    ③ Zinc  
 ④ Standard package of 10 priced per piece    ⑤ Standard package of 10 priced per package  
 ⑥ Standard package of 2 priced per package

Zinc is for saltwater only applications.  
Magnesium is for fresh water only applications.  
Aluminum is for brackish water or salt water environments.



② 18-6114  
③ 18-6067  
① 18-6067A  
**ANODE**  
Replaces: 806189, A1, Q1, T1  
For: Alpha One, Gen II (1991 & up)



③ 18-6068  
**ANODE**  
Replaces: 826134, Q  
Alpha One (Gen II)



② 18-6099  
③ 18-6080  
① 18-6080A  
**ANODE**  
Replaces: 821629, A1, Q1  
For: Alpha One (Gen II) (1991 & UP)



② 18-6089  
③ 18-6092  
① 18-6092A  
**ANODE**  
Replaces: 806190, A1, Q1, T1  
All Bravos



② 18-6079  
③ 18-6093  
① 18-6093A  
**ANODE**  
Replaces: 806105, A1, Q1, T1  
For: Alpha One (Gen II) (1991 & UP)



① 18-6150A  
② 18-6150M  
③ 18-6150Z  
**ANODE KIT**  
Replaces: 888756Q02  
For: MR & Alpha One Drives



② 18-6240  
③ 18-6094  
① 18-6094A  
**ANODE**  
Replaces: 821630, A1, Q1, T1  
All Bravos

— CONTAINS —

Part #	Description	O.E. #	Qty.
18-2599	Face Seal and Tool	26-818575A2	1
18-2564	Water Pump Base To Face Plate Gasket	27-43033-1	1
18-2566	Face Plate to Water Pump Cover Gasket	27-817277	1
18-2945	Sealing Washer	12-19183	1
18-2944	Seal	26-45577	1
18-2002	Oil Seal	26-76868	1
18-2013	Oil Seal	26-16977	1
18-2014	Oil Seal	26-89238	1
18-2054	Oil Seal	26-81646-1	1
18-2076	Oil Seal	26-12224	1
18-2077	Oil Seal	26-14077	1
18-7159	O-Ring	25-31534	1
18-7168	O-Ring	25-48171	2
18-7176	O-Ring	25-90011	1
18-7420	O-Ring	25-21836	2
18-7440-1	O-Ring	25-36318	2
18-2056	Oil Seal	26-66302	2
18-7413	O-Ring	25-62702	1



**18-2646-1**  
**LOWER UNIT SEAL KIT**  
Replaces: 26-816575A3  
For: Alpha Gen II

— CONTAINS —

Part #	Description	O.E. #	Qty.
18-2516	Bravo Outdrive Seal	16755	1
18-1240	Outdrive Seal	12708	1
18-2945	Gear Housing Drain Screw Gasket	12-19183	1
18-7198	O-Ring	25-45710	1
18-7102	O-Ring	25-62706	1
18-7105	O-Ring	25-62705	1
18-7449	O-Ring	25-97387	1
18-7153	O-Ring	25-25439	2
18-7167	O-Ring	25-97386	1
18-2010	Oil Seal	26-12709	1
18-2715	Spring Kit	24-17997A1	1
18-7117	O-Ring	25-35027	1
18-7169	O-Ring	25-70937	1



**18-2643**  
**UPPER UNIT SEAL KIT**  
Replaces: 26-16709A2  
BRAVO - BLACKHAWK

① Aluminum      ② Magnesium      ③ Zinc      ④ Standard package of 10 priced per piece  
**SEAL KIT APPLICATION BEGINS ON PAGE 737**

— CONTAINS —

Part #	Desc.	O.E. #	Qty.
18-2944	Seal Gasket	26-45577	1
18-2945	Drain Screw Gasket	12-19183	3
18-7188	Drain Screw O-Ring	26-805726	1
18-7169	O-Ring	25-70937	1
18-7161	O-Ring	25-32546	1
18-7420	O-Ring	25-25439	2
18-7103	O-Ring	25-29845	2
18-7117	O-Ring	25-35027	1
18-2056	Oil Seal	26-66302	2
18-2003	Oil Seal	26-823894	1
NSS	Water Tube Seal	26-88397	1
18-3289	Double Lip Seal	26-864319	1
18-2715	Spring Kit	24-17997A1	1



**18-2644**  
**UPPER UNIT SEAL KIT**  
 Replaces: 26-88397A1  
 ALPHA I GENERATION II

— CONTAINS —

Part #	Description	O.E. #	Qty.
18-2944	Seal Gasket	26-45577	1
18-2945	Gear Housing Drain Screw Gasket	12-19183	1
18-7163	O-Ring	25-33465	1
18-7159	O-Ring	25-31534	1
18-2002	Oil Seal	26-76868	2
18-0563	Seal	26-36556	1

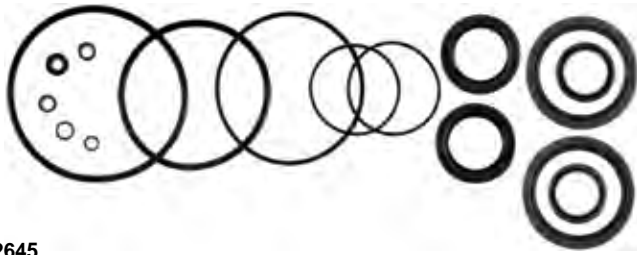

**18-2645**  
**LOWER UNIT SEAL KIT**  
 Replaces: 26-76868A2  
 Bravo I and II MODELS ONLY

— CONTAINS —

Part #	Description	O.E. #	Qty.
18-2945	Gear Hsg. Drain Screw Gasket	12-19183	2
18-0894	Water Pocket Cover Gasket	27-55810	1
18-2003	Oil Seal	26-68493	1
18-2049	Oil Seal	26-32511	1
18-2056	Oil Seal	26-96503	1
18-2944	Seal Ring Gasket	26-45577	1
18-3110	Bushing	26-38970	1
18-7153	O-Ring	25-25439	2
18-7161	O-Ring	25-32546	1
18-7169	O-Ring	25-70937	1
18-7445	O-Ring	25-55801	1



**18-2648**  
**UPPER UNIT SEAL KIT**  
 Replaces: 26-32511A1  
 S/N 1684188 & UP  
 For #1 Units (Including ALPHA) (Also fits 888 Stern drive)  
 S/N 3106717 & UP

— CONTAINS —

Part #	Description	O.E. #	Qty.
18-2919	Water Pump to Gear Hsg. Gasket	27-42631-1	1
18-3110	Grommet	26-38970	1
18-2002	Oil Seal	26-76868	1
18-2013	Oil Seal	26-16977	2
18-2014	Oil Seal	26-89238	1
18-2826	Water Pump Base to Gear Hsg. Gasket	27-85610-1	1
18-2914	Lower Water Pump to Wear Plate Gasket	27-85608-1	1
18-2915	Upper Water Pump to Wear Plate Gasket	27-85609-1	1
18-2944	Seal Ring Gasket	26-45577	1
18-2948	Gear Housing Plastic Flush Screw Gasket	12-49221-1	1
18-7158	O-Ring	25-30613	1
18-7159	O-Ring	25-31534	1
18-7162	O-Ring	25-33145	1
18-7176	O-Ring	25-90011	1
—	O-Ring	25-38099	1
18-2154	Bushing, Shift Shaft	23-30617A2	1
18-2076	Line Cutter Oil Seal	26-12224	1
18-7426	O-Ring	25-30271	1
18-2945	Gear Housing Drain Screw Gasket	12-20260, 12-19183	2

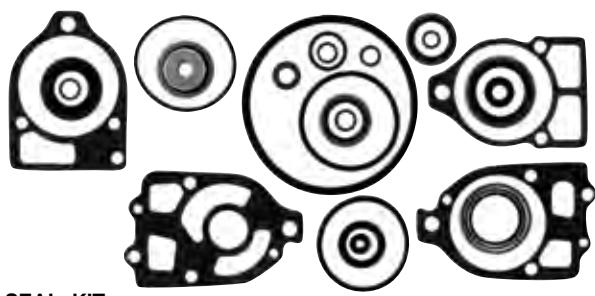

**18-2652**  
**LOWER UNIT SEAL KIT**  
 Replaces: 26-33144A2  
 S/N 1684188 & UP  
 For #1 Units (Including ALPHA)

— CONTAINS —

Part #	Description	O.E. #	Qty.
18-2652	Lower Gear Housing Seal Kit	26-33144A2	1
18-1155	Ball Bearing	30-88957A1	1
18-1117	Pinion Bearing	31-42647A1	1
18-1143	Tapered Roller Bearing	31-36387A1	1
18-3719	Pinion Nut	11-35921	1
18-2299	Tab Washer	14-79447	1
18-2298	Tab Washer	14-18323	1
18-1158	Needle Roller Bearing	31-30956	1
18-1159	Tapered Roller Bearing	31-35928A1	1
18-2285	Shim Kit	15-47397A1	1
18-1157	Needle Roller Bearing	31-30895	1
18-2343	Washer	12-982721	1
18-2294	Shim Kit	2470	1



**18-8208**  
**SEAL & BEARING KIT**  
 Replaces: 31-803090T1  
 For: MR/Alpha Drive

SEAL KIT APPLICATION BEGINS ON NEXT PAGE



**18-8370**  
**COMPLETE LOWER GEAR CASE REBUILD KIT**  
 Includes Water Pump and Complete Seal Kit  
 For Mercuriser R/MR/ALPHA 1

--- CONTAINS ---			
Part #	Description	O.E. #	Qty.
18-2340	Shift Shft Rubber Washer	12-31266	1
18-2076	Oil Seal	26-12224	1
18-7159	O-Ring	25-31534	1
18-2002	Oil Seal	26-76868	1
18-3109	Water Tube	23-29804	1
18-2154	Shift Bushing	23-30617A2	1
18-3116	Housing	46-96148A1	1
18-3017	Impeller	47-89984	1
18-2914	Water Pump Gasket	27-85608-1	1
18-7158	O-Ring	25-30613	1
18-7176	O-Ring	25-90011	1
18-2944	Seal Ring Gasket	26-45577	1
18-7173	O-Ring	25-30224	1
18-2826	Water Pump Base to Gear Housing Gasket	27-85610-1	1
18-2915	Water Pump Gasket	27-85609-1	1
18-3117	Plate	32435	1
18-7162	O-Ring	25-33145	1
18-2919	Water Pump Gasket	27-42631-1	1
18-2801	Water Pump Gasket	27-32438	1
18-7426	O-Ring	35-30271	1
18-2945	Drain Gasket	26-20260, 12-19183	2
18-3110	Grommet	26-38970	1
18-2013	Seal	26-16977	1
18-2014	Seal	26-89238	1

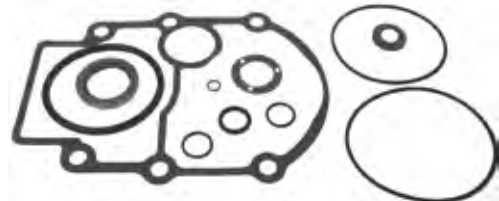

**18-8371**  
**UPPER GEARCASE SEAL KIT**  
 For: TR & TRS Drives

Stern Drive Model	Years	S/N	Bearing Carrier O-Ring	Bearing Carrier Seals	Upper Unit Seal Kit	Lower Unit Seal & Brg. Kit	Lower Unit Seal Kit	U-Joint Carrier Seal
60/80/90	1965-72	1830753 - 3225967	18-7160	18-2011/18-2015	N/A	N/A	N/A	N/A
I	1963	1534570 - 1684187	18-7157	18-2002	18-2648	N/A	18-2652	18-0577
IA, IB, IC & EZ Shift	1964-66	1684188 - 2065189	18-7157	18-2002	18-2648	N/A	18-2652	18-0577
120/140	1967-69	2062141 - 6225576	18-7157	18-2002	18-2648	N/A	18-2652	18-0577
470/485	1976-82	4208730 - 6225576	18-7157	18-2002	18-2648	N/A	18-2652	18-0577
160/165	1967-77	2065190 - UP	18-7157	18-2002	18-2648	N/A	18-2652	18-0577
888	1971-77	3106717 - UP	18-7157	18-2002	18-2648	N/A	18-2652	18-0577
225/233	1974-77	3856268 - UP	18-7157	18-2002	18-2648	N/A	18-2652	18-0577
898/228/250/260	1977-82	4782330 - 4898729	18-7157	18-2002	18-2648	N/A	18-2652	18-0577
R	1983	6225577 - UP	18-7157	18-2002	18-2648	18-8207	18-2652	18-0577
MR / Alpha One	1984-90	6225577 - UP	18-7157	18-2002	18-2648	18-8208	18-2652	18-0577
MR / Alpha One	1984-90	6225577 - UP	18-7157	18-2077/18-2076	18-2648	18-8208	18-2652	18-0577
MR / Alpha One (CR)	1984-90	6225577 - UP	18-7157	18-2077/18-2076	18-2648	—	18-2652	18-0577
Alpha One SS	1986-89	A545004 - UP	18-7157	18-2002	18-2648	—	18-2652	18-0577
Alpha One SS	1986-89	A545004 - UP	18-7157	18-2077/18-2076	18-2648	—	18-2652	18-0577
Alpha One Gen II	1991-95	D469859 - F679999	18-7157	18-2077/18-2076	18-2644	—	18-2646-1	18-0577
Alpha One Gen II (CR)	1991-95	D469859 - F679999	18-7157	18-2077/18-2076	18-2644	—	18-2646-1	18-0577
Alpha One Gen II	1996-97	F680000 - K999999	18-7157	18-2077/18-2076	18-2644	—	18-2646-1	18-0577
Alpha One Gen II (CR)	1996-newer	F680000 - UP	18-7157	18-2077/18-2076	18-2644	—	18-2646-1	18-0577
Alpha One Gen II	1998-newer	L100040 - UP	18-7157	18-2077/18-2076	18-2644	—	18-2646-1	18-0577
Bravo I	1988-newer	B664190 - UP	18-7157	18-2002	18-2643	—	18-2645	—
Bravo II	1988-newer	B664190 - UP	18-7453	18-0536	18-2643	—	18-2645	—
Bravo III	1988-newer	B664190 - UP	18-7447	—	18-2643	—	18-2645	—
Blackhawk	1994-95	F186717 - UP	18-7451	—	18-2643	—	N/A	—
II	1962-69	1474909 - 2671321	18-7157	—	N/A	—	N/A	—
III	1968-72	2373127 - 3002613	—	—	N/A	—	N/A	—
215E/H	1970-72	2909035 - 2915034	18-7453	18-0536	N/A	—	N/A	—
TR	1973-93	3377316 - UP	18-7453	—	18-8371	—	N/A	—
TRS	1973-93	3377316 - UP	18-7157	18-2002	18-8371	—	N/A	—

① Line Cutter Seal



**18-4456**  
**EXHAUST PROTECTOR VALVE**  
 Replaces: 34765A1, 34765A2  
 INCLUDES STAINLESS STEEL CLAMP  
 3"



**18-4457**  
**EXHAUST PROTECTOR VALVE**  
 Replaces: 12644A1  
 INCLUDES STAINLESS STEEL CLAMP  
 4"



**18-4458**  
**EXHAUST PROTECTOR VALVE**  
 (Fits both 5" & 6" Exhaust)  
 INCLUDES STAINLESS STEEL CLAMP

② Items ending in "D" are Display Packaged - Regular number is Non-Display

# OIL SEALS



**OIL SEALS**

Part #	O.E. #	Shaft Size (inches)	Dimensions		Part #	O.E. #	Shaft Size (inches)	Dimensions	
			O.D.	Width (inches)				O.D.	Width (inches)
18-0172	26-97530	0.845	1.500	0.315	18-2007	26-94038	1.000	1.500	0.312
18-0515	26-30530	0.540	1.004	0.303	18-2008	26-56788	0.875	1.250	0.375
18-0516	26-30913	0.500	0.839	0.187	18-2009	26-89236	0.375	0.750	0.250
18-0517	26-32911	1.100	1.260	0.127	18-2009	26-892361	0.375	0.750	0.250
18-0519	26-14240	3.792	4.536	0.482	18-2010	26-96063	0.437	0.875	0.250
18-0522	26-43036	1.045	1.474	0.187	18-2011	26-90562	0.750	1.250	0.312
18-0523	26-43993	1.640	2.132	0.282	18-2013	26-16977	0.875	1.250	0.188
18-0525	26-45587	0.390	0.628	0.124	18-2014	26-89238	0.875	1.500	0.312
18-0526	26-48443	0.750	1.379	0.256	18-2015	26-23517	0.750	1.250	0.250
18-0527	26-56397	0.750	1.127	0.343	18-2016	26-41953	1.187	1.875	0.250
18-0529	26-62818	1.640	2.256	0.319	18-2017	26-32121	0.750	1.000	0.125
18-0531	26-72785	0.790	1.880	0.248	18-2019	26-27163	0.688	1.124	0.250
18-0537	26-85107	1.020	1.507	0.251	18-2019	26-26805	0.688	1.124	0.250
18-0578	26-67388	1.800	3.100	0.500	18-2026	26-16977	0.875	1.250	0.188
18-2002	26-78868	1.188	1.692	0.250	18-2048	26-24590	0.400	0.566	0.094
18-2003	26-68493	2.250	3.000	0.437	18-2049	26-32511	1.250	2.005	0.388
18-2004	26-20070	0.625	1.000	0.250	18-2050	26-55682	1.000	1.253	0.125
18-2006	26-33467	0.625	1.125	0.312	18-2051	26-69188	0.875	1.253	0.278
					18-2052	26-69189	0.875	1.314	0.322
					18-2053	26-70081	1.185	1.754	0.360
					18-2054	26-816464	0.375	0.750	0.243
					18-2055	26-79831	0.750	1.127	0.149
					18-2056	26-96503	0.885	1.381	0.251
					18-2056	26-965031	0.885	1.381	0.251
					18-2076	26-12224	1.188	1.690	0.360
					18-2077	26-14077	1.188	1.689	0.247

① Line Cutter Seal

## DRIVESHAFT HOUSING

Stern Drive Model	Beg. S/N	End. S/N	Oil Seal	Desc.	Qty.	Stern Drive Model	Beg. S/N	End. S/N	Oil Seal	Desc.	Qty.
R/MR/Alpha I	6225577	UP	18-2003	BC	1	250	4791300	4898729	18-2003	BC	1
Alpha I SS		ALL	18-2003	BC	1	250	4791300	4898729	18-2056	LDS	1
Alpha I SS		ALL	18-2056	LDS	1	260	4898730	6225576	18-2049	GC	1
Alpha I SS		ALL	18-2049	GC	1	260	4898730	6225576	18-2056	LDS	1
IA,IB,IC	1684188	2065189	18-2003	BC	1	260	4898730	6225576	18-2003	BC	1
I,IA,IB,IC	1534570	2065189	18-2049	GC	1	470	4208730	6225576	18-2056	LDS	1
IA,IB,IC	1749276	2065189	18-2056	LDS	1	470	4208730	6225576	18-2003	BC	1
II	1474909	2671321	18-2003	BC	1	470	4208730	6225576	18-2049	GC	1
120/140	2062141	6225576	18-2003	BC	1	485	4893835	UP	18-2003	BC	1
120/140	2062141	6225576	18-2056	LDS	1	485	4893835	UP	18-2049	GC	1
120/140	2062141	6225576	18-2049	GC	1	485	4893835	UP	18-2056	LDS	1
160/165	2065190	UP	18-2003	BC	1	888	3106717	UP	18-2056	LDS	1
160/165	2065190	UP	18-2049	GC	1	888	3106717	UP	18-2049	GC	1
160/165	2065190	UP	18-2056	LDS	1	888	3106717	UP	18-2003	BC	1
225-S	3856268	4200499	18-2056	LDS	1	898/228	4782330	6225576	18-2049	GC	1
225-S	3856268	4200499	18-2049	GC	1	898/228	4782330	6225576	18-2003	BC	1
225-S	3856268	4200499	18-2003	BC	1	898/228	4782330	6225576	18-2056	LDS	1
233	4200500	UP	18-2049	GC	1						
233	4200500	UP	18-2003	BC	1						
233	4200500	UP	18-2056	LDS	1						
250	4791300	4898729	18-2049	GC	1						

BC Bearing Carrier Seal  
GC Gear Chamber Seal  
LDS Lower Driveshaft Seal

## GEAR HOUSING

Stern Drive Model	Beg. S/N	End. S/N	Oil Seal	Desc.	Qty.	Stern Drive Model	Beg. S/N	End. S/N	Oil Seal	Desc.	Qty.
MR/Alpha I	6225577	UP	18-2002	PS	2	IA,IB,IC	1684188	2065189	18-2013	WPB	1
R/MR/Alpha I	6225577	UP	18-2009	SSB	1	IA,IB,IC	1684188	2065189	18-2013	WP	1
R/MR/Alpha I	6225577	UP	18-2014	WPB,L	1	IA,IB,IC	1684188	2065189	18-2009	SSB	1
MR/Alpha I	6225577	UP	18-2013	WPB,U	1	TRS	4794900	UP	18-2002	PS	2
R	6225577	UP	18-2013	WPB,U	1	60	1830753	2063740	18-2009	SSB	1
Alpha I SS	ALL		18-2014	WPB,L	1	60	1830753	2063740	18-2011	WPB,L	1
Alpha I SS	ALL		18-2009	SSB	1	60	1830753	2063740	18-2055	WPB,U	1
Alpha I SS	ALL		18-2013	WPB,U	1	60	1830753	2063740	18-2015	PS,O	1
Alpha I SS	ALL		18-2002	PS	2	60	1830753	2063740	18-2011	PS,I	1
BRAVO I	B664190	UP	18-2002	PS	2	80	2063741	2898029	18-2002	PS	2
I	1534570	1536617	18-2009	WPB	1	80	2063741	2898029	18-2009	SSB	1
I	1534570	1684187	18-2009	SSB	1	80	2063741	2898029	18-2055	WPB,U	1
I	1534570	1684187	18-2002	PS	2	80	2063741	2898029	18-2011	WPB,L	1
I	1534570	1684187	18-2013	WP	1	90	2898020	3225967	18-2009	SSB	1
I	1536618	1684187	18-2014	WPB	1	90	2898020	3225967	18-2002	PS	2
I	1563354	1684187	18-2013	WPB	1	90	2898020	3225967	18-2011	WPB,L	1
IA,IB,IC	1684188	2065189	18-2014	WPB	1	90	2898020	3225967	18-2055	WPB,U	1
IA,IB,IC	1684188	2065189	18-2002	PS	2	120/140	2062141	6225576	18-2013	WPB,U	1

GEAR HOUSING (Cont.)											
Stern Drive Model	Beg. S/N	End. S/N	Oil Seal	Desc.	Qty.	Stern Drive Model	Beg. S/N	End. S/N	Oil Seal	Desc.	Qty.
120/140	2062141	4893634	18-2013	WP	1	470	4208730	6225576	18-2009	SSB	1
120/140	2062141	6225576	18-2014	WPB,L	1	470	4208730	6225576	18-2014	WPB,L	1
120/140	2062141	6225576	18-2009	SSB	1	470	4208730	6225576	18-2002	PS	2
120/140	2062141	6225576	18-2002	PS	2	470	4208730	6225576	18-2013	WPB,U	1
160/165	2065190	UP	18-2009	SSB	1	485	4893835	UP	18-2002	PS	2
160/165	2065190	UP	18-2014	WPB,L	1	485	4893835	UP	18-2009	SSB	1
160/165	2065190	UP	18-2002	PS	2	485	4893835	UP	18-2013	WPB,U	1
160/165	2065190	4890459	18-2013	WP	1	485	4893835	UP	18-2014	WPB,L	1
160/165	2065190	UP	18-2013	WPB,U	1	888	3106717	UP	18-2014	WPB,L	1
225-S	3856268	4200499	18-2013	WPB,U	1	888	3106717	UP	18-2009	SSB	1
225-S	3856268	4200499	18-2014	WPB,L	1	888	3106717	UP	18-2013	WP	1
225-S	3856268	4200499	18-2002	PS	2	888	3106717	UP	18-2013	WPB,U	1
225-S	3856268	4200499	18-2009	SSB	1	888	3106717	UP	18-2002	PS	2
233	4200500	UP	18-2009	SSB	1	898/228	4782330	6225576	18-2014	WPB,L	1
233	4200500	UP	18-2013	WPB,U	1	898/228	4782330	6225576	18-2013	WPB,U	1
233	4200500	UP	18-2002	PS	2	898/228	4782330	6225576	18-2009	SSB	1
233	4200500	UP	18-2014	WPB,L	1	898/228	4782330	6225576	18-2002	PS	2
250	4791300	4898729	18-2013	WPB,U	1						
250	4791300	4898729	18-2014	WPB,L	1						
250	4791300	4898729	18-2002	PS	2						
250	4791300	4898729	18-2009	SSB	1						
255-TRS	3377316	4203749	18-2002	PS	2						
260	4898730	6225576	18-2009	SSB	1						
260	4898730	6225576	18-2002	PS	2						
260	4898730	6225576	18-2013	WPB,U	1						
260	4898730	6225576	18-2014	WPB,L	1						
280-TRS	4203750	4895399	18-2002	PS	2						

PS	Prop Shaft Seal
PS,I	Prop Shaft, Inner Seal
PS,O	Prop Shaft, Outer Seal
SSB	Shift Shaft Bushing Seal
WPB	Water Pump Base Seal
WPB,L	Water Pump Base, Lower Seal
WPB,U	Water Pump Base, Upper Seal
WP	Water Pump Body Seal

## O-RINGS

Part #	O.E. #	Dimensions	
		I. D.	Width (inches)
18-7161	25-32546	3.250	.070
18-7162	25-33145	2.025	.135
18-7163	25-33465	2.415	.100
18-7164	25-33466	1.375	.100
18-7165	25-45253	.500	.065
18-7165	25-32509	.500	.065
18-7166	25-45254	.615	.065
18-7167	25-97386	3.609	.139
18-7168	25-48171	.370	.065
18-7169	25-70937	3.500	.135
18-7170	25-33504	1.365	.135
18-7171	25-30529	1.920	.100
18-7172	25-31305	3.250	.135
18-7173	25-30224	1.875	.135
18-7174	25-45711	.620	.100
18-7175	25-62817	3.750	.270
18-7176	25-90011	2.160	.100
18-7177	25-53421	2.625	.065
18-7180	25-26802	.445	.090
18-7188	25-805726	.361	.0635
18-7198	25-45710	1.430	.100
18-7411	25-35480	1.250	.100
18-7413	25-62702	.301	.070
18-7414	25-64067	1.989	.070
18-7415	25-64966	3.739	.070
18-7419	25-69202	2.675	.103
18-7420	25-25439	.862	.139
18-7421	25-20415	.150	.065
18-7426	25-30271	.740	.310
18-7440-1	25-36318	.799	.103
18-7445	25-55801	.801	.070
18-7449	25-97387	4.487	.103
18-7459	25-20826	2.234	.139
18-7464	25-39695	4.234	.139
18-7467	25-54030	2.987	.103
18-7474	25-94288	1.239	.070
18-7961	25-97386	3.650	.135

① PKG. OF 1      ② PKG. OF 5      ③ PKG. OF 2      ④ PKG. OF 3

**DRIVESHAFT HOUSING**

Stern Drive Model	Beg. S/N	End. S/N	Oil Seal	Desc.	Qty.	Stern Drive Model	Beg. S/N	End. S/N	Oil Seal	Desc.	Qty.
R/MR/Alpha I	6225577	UP	18-7153	UJ	2	233	4200500	UP	18-7169	BC	1
R/MR/Alpha I	6225577	UP	18-7169	BC	1	250	4791300	4898729	18-7153	UJ	2
R/MR/Alpha I	6225577	UP	18-7161	TC	1	250	4791300	4898729	18-7169	BC	1
Alpha I SS	ALL		18-7161	TC	1	250	4791300	4898729	18-7161	TC	1
Alpha I SS	ALL		18-7169	BC	1	255-TRS	3377316	4203749	18-7175	DSH	1
Alpha I SS	ALL		18-7153	UJ	2	260	4898730	6225576	18-7169	DG	1
BRAVO (I/II)	B664190	UP	18-7198	DSH	1	260	4898730	6225576	18-7161	TC	1
BRAVO (I/II)	B664190	UP	18-7153	UJ	2	260	4898730	6225576	18-7170	BH	1
I	1534570	1684187	18-7127	DG	1	260	4898730	6225576	18-7153	UJ	2
I,IA,IB,IC	1534570	1777798	18-7165	USSL	1	280-TRS	4203750	4895399	18-7175	DSH	1
I,IA,IB,IC	1535212	2065189	18-7170	BH	2	470	4208730	6225576	18-7169	BC	1
IA,IB,IC	1684188	2065189	18-7153	UJ	2	470	4208730	6225576	18-7161	TC	1
IA,IB,IC	1684188	2065189	18-7169	BC	1	470	4208730	6225576	18-7153	UJ	2
II	2398798	2671321	18-7153	UJ	2	470	4893835	6225576	18-7170	BH	1
II SSM	ALL		18-7175	DSH	1	485	4893835	UP	18-7161	TC	1
II SSM	ALL		18-7153	UJ	2	485	4893835	UP	18-7170	BH	1
II TR	3377316	4794899	18-7175	DSH	1	485	4893835	UP	18-7153	UJ	2
III/III SSM	ALL		18-7115	FC	1	485	4893835	UP	18-7169	DG	1
IV SSM ①	ALL		18-7115	FC	1	888	3106717	UP	18-7161	TC	1
I/IA/IB/IC	1534570	2065189	18-7161	TC	1	888	3106717	UP	18-7169	BC	1
TR/TRS ③	4794900	UP	18-7153	UJ	2	888	3106717	UP	18-7153	UJ	2
TR/TRS	4794900	UP	18-7175	DSH	1	898/228	4782330	6225576	18-7169	BC	1
120/140	2062141	6225576	18-7161	TC	1	898/228	4782330	6225576	18-7161	TC	1
120/140	2062141	6225576	18-7170	BH	1	898/228	4782330	6225576	18-7153	UJ	2
120/140	2062141	6225576	18-7169	DG	1	898/228	4898730	6225576	18-7170	BH	1
120/140	2062141	6225576	18-7153	UJ	2						
160/165	2065190	UP	18-7170	BH	1						
160/165	2065190	UP	18-7169	DG	1						
160/165	2065190	UP	18-7153	UJ	2						
160/165	2065190	UP	18-7161	TC	1						
215H	2782203	2909034	18-7153	UJ	2						
215H	2782203	2909034	18-7146	PC	1						
215E ②	2909035	2915034	18-7174	FC	1						
215E	2909035	2915034	18-7146	CC	1						
225-S	3856268	4200499	18-7153	UJ	2						
225-S	3856268	4200499	18-7169	BC	1						
225-S	3856268	4200499	18-7161	TC	1						
233	4200500	UP	18-7161	TC	1						
233	4200500	UP	18-7153	UJ	2						

- ① 1 ST Design
- ② 5/8" ID
- ③ With Borg Warner Transmission
- BC Bearing Carrier Seal
- BH Bell Housing Seal
- CC Crankshaft Cover Seal
- DG Drive Gear Seal
- DSH Driveshaft Housing Seal
- FC Front Cover Seal
- PC Plug Cover Seal
- TC Top Cover Seal
- USSL Upper Shift Shaft Lever Seal
- UJ U-Joint Yoke Seal

**GEAR HOUSING**

Stern Drive Model	Beg. S/N	End. S/N	Oil Seal	Desc.	Qty.	Stern Drive Model	Beg. S/N	End. S/N	Oil Seal	Desc.	Qty.
R/MR/Alpha I	6225577	UP	18-7162	WPB	1	90	2898020	3225967	18-7155	WOAL	1
MR/Alpha I	6225577	UP	18-7176	WPB	1 ②	120/140	2062141	6225576	18-7153	SSB	1
R/MR/Alpha I	6225577	UP	18-7158	UDS	1	120/140	2062141	6225576	18-7158	UDS	1
R/MR/Alpha I	6225577	UP	18-7159	PBH	1	120/140	2062141	6225576	18-7159	PBH	1
R/MR/Alpha I	6225577	UP	18-7153	SSB	1	120/140	2062141	6225576	18-7162	WPB	1
Alpha I SS	ALL		18-7159	PBH	1	120/140	4893635	6225576	18-7114	GH	1 ③
Alpha I SS	ALL		18-7158	UDS	1	160/165	2065190	UP	18-7162	WPB	1
Alpha I SS	ALL		18-7153	SSB	1	160/165	2065190	UP	18-7153	SSB	1
Alpha I SS	ALL		18-7176	WPB	1 ②	160/165	2065190	UP	18-7158	UDS	1
BRAVO I	B664190	UP	18-7159	PBH	1	160/165	2065190	UP	18-7159	PBH	1
BRAVO I/II	B664190	UP	18-7163	GH	1	165	4890460	UP	18-7114	GH	1 ③
I	1534570	1684187	18-7157	PBH	1	225-S	3856268	4200499	18-7153	SSB	1
I	1534570	1536617	18-7153	WPB	1	225-S	3856268	4200499	18-7162	WPB	1
I	1534570	1684187	18-7153	SSB	1	225-S	3856268	4200499	18-7158	UDS	1
I,IA,IB,IC	1534570	2065189	18-7158	UDS	1	225-S	3856268	4200499	18-7159	PBH	1
I,IA,IB,IC	1536618	2065189	18-7162	WPB	1	233	4200500	UP	18-7162	WPB	1
IA,IB,IC	1684188	2065189	18-7159	PBH	1	233	4200500	UP	18-7158	UDS	1
IA,IB,IC	1684188	1777798	18-7153	WPB	1	233	4200500	UP	18-7159	PBH	1
IA,IB,IC	1684188	2065189	18-7153	SSB	1	233	4200500	UP	18-7153	SSB	1
II	1474909	2671321	18-7159	PBH	1	250	4791300	4898729	18-7159	PBH	1
III	ALL		18-7151	BRL	1	250	4791300	4898729	18-7158	UDS	1
III	ALL		18-7174	BRS	1	250	4791300	4898729	18-7162	WPB	1
TRS	4794900	UP	18-7159	PBH	1	250	4791300	4898729	18-7153	SSB	1
60	1830753	2063740	18-7153	SSB	1	255-TRS	3377316	4203749	18-7159	PBH	1
60	1830753	2063740	18-7160	PBH	1	260	4898730	6225576	18-7162	WPB	1
60	1830753	2063740	18-7155	WOAL	1	260	4898730	6225576	18-7159	PBH	1
60	1830753	2063740	18-7114	WOAS	1	260	4898730	6225576	18-7153	SSB	1
80	2063741	2898029	18-7157	PBH	1	260	4898730	6225576	18-7158	UDS	1
80	2063741	2898029	18-7155	WOAL	1	260	4898730	6225576	18-7114	GH	1 ③
80	2063741	2898029	18-7114	WOAS	1	280-TRS	4203750	4895399	18-7159	PBH	1
80	2063741	2898029	18-7153	SSB	1	470	4208730	6225576	18-7159	PBH	1
90	2898020	3225967	18-7114	WOAS	1	470	4208730	6225576	18-7162	WPB	1
90	2898020	3225967	18-7157	PBH	1	470	4208730	6225576	18-7158	UDS	1
90	2898020	3225967	18-7153	SSB	1	470	4208730	6225576	18-7153	SSB	1

⑤ This product is priced per piece. To order priced per package, please add -9 to the part number.



GEAR HOUSING (Cont.)											
Stern Drive Model	Beg. S/N	End. S/N	Oil Seal	Desc.	Qty.	Stern Drive Model	Beg. S/N	End. S/N	Oil Seal	Desc.	Qty.
470	4893835	6225576	18-7114	GH	1 ③	③	V-8 Engines Only				
485	4893835	UP	18-7158	UDS	1	BRL	Bearing Retainer Large Seal				
485	4893835	UP	18-7162	WPB	1	BRS	Bearing Retainer Small Seal				
485	4893835	UP	18-7153	SSB	1	GH	Gear Housing Seal				
485	4893835	UP	18-7114	GH	1 ③	PGH	Prop Bearing Housing Seal				
485	4893835	UP	18-7159	PBH	1	SSB	Shift Shaft Bushing				
888	3106717	UP	18-7162	WPB	1	UDS	Upper Driveshaft Seal				
888	3106717	UP	18-7158	UDS	1	WOAL	Water & Oil Adapter Large Seal				
888	3106717	UP	18-7153	SSB	1	WOAS	Water & Oil Adapter Small Seal				
888	3106717	UP	18-7159	PBH	1	WPB	Water Pump Base Seal				
898/228	4782330	6225576	18-7158	UDS	1						
898/228	4782330	6225576	18-7153	SSB	1						
898/228	4782330	6225576	18-7159	PBH	1						
898/228	4782330	6225576	18-7162	WPB	1						
898/228	4898730	6225576	18-7114	GH	1 ③						
①	2.019 ID										
②	2.17 ID										

GIMBAL HOUSING											
Stern Drive Model	Beg. S/N	End. S/N	Oil Seal	Desc.	Qty.	Stern Drive Model	Beg. S/N	End. S/N	Oil Seal	Desc.	Qty.
R/MR/Alpha I	6225577	UP	18-7170	BH	1	260	4898730	6225576	18-7152	EE	1
BRAVO (I/II)	B664190	UP	18-7168	V	2 ①	470	4208730	6225576	18-7152	EE	1
I	1534570	1641940	18-7165	GHB	2	470	4208730	4893934	18-7170	BH	1
II	1474909	1475005	18-7151	SL	1	485	4893835	UP	18-7152	EE	1
II	1602186	2671321	18-7162	GHAS	1	888	3106717	UP	18-7170	BH	1
II	1732380	2671321	18-7172	GHAL	1	888	3106717	UP	18-7114	GH	1
III/III SSM/IV		ALL	18-7159	BH	1	888	3106717	UP	18-7152	EE	1
60	1830753	2063740	18-7172	BH	1	898/228	4782330	4898729	18-7170	BH	1
80	2063741	2898029	18-7172	BH	1	898/228	4782330	4898729	18-7114	GH	1
90	2898020	3225967	18-7172	BH	1	898/228	4782330	6225576	18-7152	EE	1
120/140	2062141	6225576	18-7152	EE	1						
160/165	2065190	UP	18-7152	EE	1	①	With Oil Reservoir				
225-S	3856268	4200499	18-7170	BH	1	BH	Bell Housing Seal				
225-S	3856268	4200499	18-7152	EE	1	EE	Exhaust Elbow Seal				
225-S	3856268	4200499	18-7114	GH	1	GH	Gimbal Housing Seal				
233	4200500	UP	18-7152	EE	1	GHAL	Gimbal Housing Adapter Large Seal				
233	4200500	UP	18-7114	GH	1	GHAS	Gimbal Housing Adapter Small Seal				
233	4200500	UP	18-7170	BH	1	GHB	Gimbal Housing Bolt Seal				
250	4791300	4898729	18-7152	EE	1	SL	Steering Lever Seal				
250	4791300	4898729	18-7114	GH	1	V	Valve Seal				
250	4791300	4898729	18-7170	BH	1						

HYDRAULIC PUMP ASSY											
Stern Drive Model	Beg. S/N	End. S/N	Oil Seal	Desc.	Qty.	Stern Drive Model	Beg. S/N	End. S/N	Oil Seal	Desc.	Qty.
R/MR/Alpha I	6225577	UP	18-7168	CV	4	233	4200500	UP	18-7168	CV	4
BRAVO (I/II)	B664190	UP	18-7134	ORC	1	255-TRS	3377316	4203749	18-7168	CV	4
BRAVO (I/II)	B664190	UP	18-7158	ORS	1	260	4898730	6225576	18-7168	CV	4
II	2398798	2671321	18-7168	CV	4	280-TRS	4203750	4895399	18-7168	CV	4
II TR	3377316	4794899	18-7168	CV	4	470	4208730	6225576	18-7168	CV	4
III/III SSM/IV		ALL	18-7168	CV	4	485	4893835	UP	18-7168	CV	4
TR/TRS	4794900	UP	18-7168	CV	4	888	3106717	UP	18-7168	CV	4
90	2898020	3225967	18-7168	CV	4	898/228	4898730	6225576	18-7168	CV	4
120/140	2062141	6225576	18-7168	CV	4						
160/165	2065190	UP	18-7168	CV	4	CV	Control Valve				
215H/E	2782203	2915034	18-7168	CV	4	ORC	Oil Reservoir Connector				
225-S	3856268	4200499	18-7168	CV	4	ORS	Oil Reservoir Switch				

REVERSE LOCK VALVE											
Stern Drive Model	Beg. S/N	End. S/N	Oil Seal	Desc.	Qty.	Stern Drive Model	Beg. S/N	End. S/N	Oil Seal	Desc.	Qty.
R/MR/Alpha I	6225577	UP	18-7174	VC	1	260	4898730	6225576	18-7174	VC	1
R/MR/Alpha I	6225577	UP	18-7198	V	1	470	4208730	6225576	18-7198	V	1
II	2398798	2671321	18-7198	V	1	470	4208730	6225576	18-7174	VC	1
II	2398798	2671321	18-7174	VC	1	485	4893835	UP	18-7174	VC	1
120/140	2062141	6225576	18-7198	V	1	485	4893835	UP	18-7198	V	1
120/140	2062141	6225576	18-7174	VC	1	898/228	4782330	6225576	18-7174	VC	1
160/165	2065190	UP	18-7198	V	1	898/228	4782330	6225576	18-7198	V	1
160/165	2065190	UP	18-7174	VC	1						
250	4791300	4898729	18-7198	V	1						
250	4791300	4898729	18-7174	VC	1	V	Valve Seal				
260	4898730	6225576	18-7198	V	1	VC	Valve Cover Seal				



Display Package

**18-5001  
TUNE-UP KIT**  
Replaces: 172525

—CONTAINS—

Part #	O.E. #	Description
18-5157	580290	Contact Set
18-5200	580256	Condenser



Display Package

**18-5250  
TUNE-UP KIT**  
Replaces: 172527

—CONTAINS—

Part #	O.E. #	Description
18-5311	380538	Contact Set
18-5345	380537	Condenser
18-5418	384735	Rotor

Delco 4 & 6 cyl.



Display Package

**18-5251  
TUNE-UP KIT**  
Replaces: 173619

—CONTAINS—

Part #	O.E. #	Description
18-5314	382135	Contact Set
18-5338	382136	Condenser
18-5404-1	982211	Rotor

Mallory 8 cyl. Tall Cap



**18-5252  
TUNE-UP KIT**

—CONTAINS—

Part #	O.E. #	Description
18-5310	380543	Contact Set
18-5344	382125	Condenser
—	381711	Rotor

Delco 8 cyl.



**18-5256  
TUNE-UP KIT**  
Replaces: 172531

—CONTAINS—

Part #	O.E. #	Description
18-5314	382135	Contact Set
18-5338	382136	Condenser
18-5411	982342	Rotor

Mallory 8 cyl. Flat Cap



① 18-5258D Display Package

**18-5258  
TUNE-UP KIT**  
Replaces: 173690, 987925

—CONTAINS—

Part #	O.E. #	Description
18-5303	980893	Contact Set
18-5347	980894	Condenser
18-5407	980892	Rotor

Prestolite 8 cyl.



Display Package

**18-5260  
TUNE-UP KIT**  
Replaces: 173829, 987926

—CONTAINS—

Part #	O.E. #	Description
18-5303	980893	Contact Set
18-5347	980894	Condenser
18-5403	982880	Rotor



**Flame-Thrower**

**18-5266  
TUNE UP KIT**  
Fits: Flame Thrower Distributors 18-5481, 18-5482, 18-5483, 18-5477, 18-5478 and 18-5479



Display Package

**18-5268  
TUNE-UP KIT**

—CONTAINS—

Part #	O.E. #	Description
18-5311	380538	Contact Set
18-5345	380537	Condenser
18-5418	384735	Rotor
18-5385	380541	Distributor Cap

Delco In-Line 4 - Single Point



Display Package

**18-5269  
TUNE-UP KIT**

—CONTAINS—

Part #	O.E. #	Description
18-5311	380538	Contact Set
18-5345	380537	Condenser
18-5418	384735	Rotor
18-5386	980152	Distributor Cap

Delco In-Line 6 - Single Point



Display Package

**18-5270  
TUNE-UP KIT**

—CONTAINS—

Part #	O.E. #	Description
18-5310	380543	Contact Set
18-5344	382125	Condenser
—	381711	Rotor
18-5384	383587	Distributor Cap

Delco V-8 - Single Point



Display Package

**18-5271  
TUNE-UP KIT**

—CONTAINS—

Part #	O.E. #	Description
18-5314	382135	Contact Set
18-5338	382136	Condenser
18-5404-1	982211	Rotor
18-5376	982209	Distributor Cap

Mallory V-8 - Single Point - Top Terminal

APPLICATION BEGINS ON PAGE 750

① Items ending in "D" are Display Packaged - Regular number is Non-Display



**18-5272  
TUNE-UP KIT**  
—CONTAINS—

Part #	O.E. #	Description
18-5314	382135	Contact Set
18-5338	382136	Condenser
18-5411	982342	Rotor
18-5375	382133	Distributor Cap

Mallory Flat V-8 - Single Point - Side Terminal



**18-5275  
TUNE-UP KIT**  
—CONTAINS—

Part #	O.E. #	Description
18-5303	980893, 987136, 987894	Contact Set
18-5347	980894, 987895	Condenser
18-5403	982880	Rotor
18-5352	984401	Distributor Cap

Prestolite V-8 - Single Point - Screw Cap



**18-5276  
TUNE-UP KIT**  
—CONTAINS—

Part #	O.E. #	Description
18-5303	980893, 987136, 987894	Contact Set
18-5347	980894, 987895	Condenser
18-5403	982880	Rotor
18-5353	984398	Distributor Cap

Prestolite V-6 - Single Point - Screw Cap



**18-5277  
TUNE-UP KIT**  
—CONTAINS—

Par t#	O.E. #	Description
18-5303	980893, 987136, 987894	Contact Set
18-5347	980894, 987895	Condenser
18-5407	980892	Rotor
18-5369	982336	Distributor Cap

Prestolite V-8 - Single Point - Clip Cap



**18-5278  
TUNE-UP KIT**  
For: Delco EST V-6



**18-5279  
TUNE-UP KIT**  
For: Prestolite Electronic V-8

Part #	Description	O.E.#	Qty.
18-5352	Distributor Cap	392-9766	1
18-5403	Rotor	392-9089	1



**18-5280  
TUNE-UP KIT**  
For: Delco EST In-Line 4

Part #	Description	O.E.#	Qty.
18-5361	Distributor Cap	986643	1
18-5406	Rotor, Delco	986651	1



**18-5283  
TUNE-UP KIT**  
For: Mallory Single Point In-Line 4



**18-5157  
CONTACT SET**  
Replaces: 580290



**18-5303  
CONTACT SET**  
Replaces: 980893, 987136, 987894



**18-5310  
CONTACT SET**  
Replaces: 380543



**18-5311  
CONTACT SET**  
Replaces: 380538



**18-5314  
CONTACT SET**  
Replaces: 382135



**18-5200  
CONDENSER**  
Replaces: 580256



**18-5338  
CONDENSER**  
Replaces: 382136



**18-5344  
CONDENSER**  
Replaces: 382125



**18-5345  
CONDENSER**  
Replaces: 380537



**18-5347  
CONDENSER**  
Replaces: 980894, 987895



**18-5403  
ROTOR**  
Replaces: 982880



**18-5404-1  
ROTOR**  
Replaces: 982211



























**18-5405  
ROTOR**  
Replaces: 3854549  
V-8  
Fits new GM style "Module in Cap"



**18-5406  
ROTOR**  
Replaces: 986651  
Use with 18-5361  
Distributor Cap



**18-5407  
ROTOR**  
Replaces: 980892



 <p><b>18-5408 ROTOR</b> Replaces: 3854311 V-6 Fits new GM style "Module in Cap"</p>	 <p><b>18-5411 ROTOR</b> Replaces: 982342</p>	 <p><b>18-5413 ROTOR</b> Replaces: 987986</p>	 <p><b>18-5418 ROTOR</b> Replaces: 384735</p>	 <p><b>18-5419 ROTOR</b> Replaces: 380542</p>
 <p><b>18-5301 TUNE-UP KIT</b> Replaces: Fits: male cap v-8 flamethrower distributors</p>	 <p><b>18-5302 TUNE-UP KIT</b> Replaces: Fits: male cap v-8 flamethrower distributors</p>	 <p><b>18-5474 DISTRIBUTOR CAP</b> Red Distributor Cap with Male Terminals Petronix Dsistributors</p>	 <p><b>18-5473 DISTRIBUTOR CAP</b> Black Distributor Cap w/ Male Terminals Petronix Dsistributors</p>	 <p><b>18-5248 DISTRIBUTOR CAP</b> OMC 3854217 Fits: OMC 5.0L(1994-96), 5.8L(1994-96)</p>
 <p><b>18-5352 DISTRIBUTOR CAP</b> Replaces: 984401 Prestolite</p>	 <p><b>18-5353 DISTRIBUTOR CAP</b> Replaces: 984398 Prestolite</p>	 <p><b>18-5354 DISTRIBUTOR CAP</b> Replaces: 3854548 V-8 Fits new GM style "module in cap"</p>	 <p><b>18-5361 DISTRIBUTOR CAP</b> Replaces: 986643</p>	 <p><b>18-5362 DISTRIBUTOR CAP</b> Replaces: 3854331 V-6 Fits new GM style "Module in Cap"</p>
 <p><b>18-5369 DISTRIBUTOR CAP</b> Replaces: 982336 w/Gasket 18-5399</p>	 <p><b>18-5375 DISTRIBUTOR CAP</b> Replaces: 382133</p>	 <p><b>18-5376 DISTRIBUTOR CAP</b> Replaces: 982209</p>	 <p><b>18-5384 DISTRIBUTOR CAP</b> Replaces: 383587</p>	 <p><b>18-5385 DISTRIBUTOR CAP</b> Replaces: 380541</p>
 <p><b>18-5386 DISTRIBUTOR CAP</b> Replaces: 980152</p>	 <p><b>18-5397 DISTRIBUTOR CAP</b></p>	 <p><b>18-5107-1 IGNITION MODULE</b> Replaces: 3854003 4/6/8 cyl</p>	 <p><b>18-5464 IGNITION MODULE</b> Fits: Sierra 18-5481, 18-5482 and 18-5483 Billet HI-PERFORMANCE ELECTRONIC DISTRIBUTORS (except HEI/EST)</p>	 <p><b>18-5108 SENSOR (Pick-Up Coil)</b> Replaces: 3854001, 986642 4, V-6 and V-8 cyl.</p>

APPLICATION BEGINS ON PAGE 750



# FEATURES

- ★ Oil filled for better cooling and long life
- ★ Low resistance and improved turn ratios produces the higher voltage needed to run larger spark plug gaps for added power and better fuel economy
- ★ More windings maximize energy and reliability over the full RPM range
- ★ Fits existing brackets for easy installation

 <p><b>18-5466 HI-PERFORMANCE IGNITION COIL</b> 1.5 ohm (oil filled), black - 8 cylinder: Flame-Thrower 40,000 volt coil. ★ Designed for use with the original Ignitor Electronic Conversion Kits ★ Can be used with other inductive ignition systems</p>	 <p><b>18-5469 HI-PERFORMANCE IGNITION COIL</b> 3.0 ohm (oil filled), black - 4 &amp; 6 cylinder: Flame-Thrower 40,000 volt coil. ★ Designed for use with the original Ignitor Electronic Conversion Kits ★ Can be used with other inductive ignition systems</p>	 <p><b>18-5472 HI-PERFORMANCE IGNITION COIL</b> 0.6 ohm (oil filled), black - 4, 6, &amp; 8 cylinder:Flame-Thrower 45,000 volt coil. ★ Super low 0.6 ohm resistance coil designed for use with the Ignitor II Hi Performance Electronic Conversion Kits ★ Compatible with capacitive discharge systems</p>
--	---	---

Part #	Description	Recommended Coil	Resistance Ohms	Part #	Description	Recommended Coil	Resistance Ohms
18-5293-1	Electronic Conversion Kit	18-5469	3.0	18-5288	Hi Performance Electronic Conversion Kit	18-5472	0.6
18-5294	Electronic Conversion Kit	18-5469	3.0	18-5289	Hi Performance Electronic Conversion Kit	18-5472	0.6
18-5295	Electronic Conversion Kit	18-5469	3.0	18-5290	Hi Performance Electronic Conversion Kit	18-5472	0.6
18-5296-2	Electronic Conversion Kit	18-5466	1.5	18-5481	Flame-Thrower Distributor	18-5472	0.6
18-5298	Electronic Conversion Kit	18-5466	1.5	18-5482	Flame-Thrower Distributor	18-5472	0.6
18-5299	Electronic Conversion Kit	18-5466	1.5	18-5483	Flame-Thrower Distributor	18-5472	0.6
18-5286	Hi Performance Electronic Conversion Kit	18-5472	0.6				



**18-5433  
IGNITION COIL**  
Replaces: 915735  
Uses External Resistor  
For: 3.0L (1991 & up), 5.7 EFI (1996 & up) and 7.4L EFI (1995 & up)



**18-5437  
IGNITION COIL**  
Replaces: 383444, 378231  
Metal Encased - 12 Volt  
Uses External Resistor (For All Applications)  
For: 1990 & prior stern drives with breaker point ignition



**18-5443  
IGNITION COIL**  
Replaces: 3854002  
4 cyl./V-8  
For: 3.0L (1991 & up), 5.7 EFI (1996 & up) & 7.4 EFI (1995 & up)



**18-5888  
SHIFT ASSIST MODULE & HARNESS**  
Replaces: 987738  
For: V-8 Sterndrives  
Fits: 5.0, 5.7 GM (1986-90) 7.5 460 Ford (1987-91)



**18-5889  
SHIFT ASSIST MODULE & HARNESS**  
Replaces: 987739  
For: V-8 Sterndrives  
Fits: 5.0, 5.8 Ford (1986-90)



**18-5890  
SHIFT ASSIST MODULE & HARNESS**  
Replaces: 987740  
Fits: 2.3, 3.0, 4.3 (1986-90) & 2.5 (1986)

APPLICATION BEGINS ON PAGE 750



## FEATURES

- ★ Senses current levels in the coil and adjusts the dwell to maintain peak energy throughout the entire RPM range.
- ★ Develops, on average, 4 times more available energy between 3000 and 5000 RPM's and twice as much plug voltage as point-type systems.
- ★ Ignition energy is sustained and coil life is increased when peak current level is reached just prior to spark.
- ★ More stable timing.
- ★ Use with 18-5472 "Flame Thrower II" Coil for optimum performance



**18-5285**  
**HI-PERFORMANCE**  
**ELECTRONIC CONVERSION KIT**  
Fits: 4 Cylinder Delco Distributors



**18-5286**  
**HI-PERFORMANCE**  
**ELECTRONIC CONVERSION KIT**  
Fits: 6 Cylinder Delco Distributors



**18-5287-1**  
**HI-PERFORMANCE**  
**ELECTRONIC CONVERSION KIT**  
Fits: Fits: 6 Cylinder Prestolite Distributors



**18-5288**  
**HI-PERFORMANCE**  
**ELECTRONIC CONVERSION KIT**  
Fits: Most Prestolite V-8 Distributors with snap down cap



**18-5289**  
**HI-PERFORMANCE**  
**ELECTRONIC CONVERSION KIT**  
Fits: Most Prestolite V-8 Distributors with screw down cap



**18-5290**  
**HI-PERFORMANCE**  
**ELECTRONIC CONVERSION KIT**  
Fits: Most Mallory YL or YD 8 cylinder Distributors with clockwise and counter clockwise rotation



## FEATURES

- ★ Replaces points & condensers for true solid state ignition.
- ★ Uses standard coil, cap and rotor.
- ★ Easy to install, one-piece, 2-wire hook-up.
- ★ Accurate to within 1/4° timing accuracy 0 to 6000 RPM range.

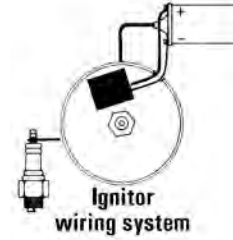
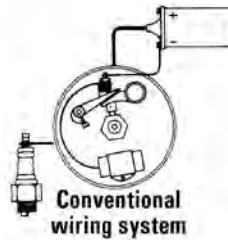

Not compatible with shift assist modules



**18-5293-1**  
**ELECTRONIC CONVERSION KIT**  
For: All Chevrolet V-6 Prestolite with screw down caps



**18-5294**  
**ELECTRONIC CONVERSION KIT**  
Fits: 6 Cyl. Delco distributors



**18-5295**  
**ELECTRONIC CONVERSION KIT**  
Fits: Most 4 Cyl. Prestolite distributors (except IBM 7026)  
For: Onan, Universal, Waukesha, Wisconsin

Not compatible with shift assist modules

APPLICATION BEGINS ON PAGE 750

① 18-5296-2D Display Package



**18-5296-2  
ELECTRONIC  
CONVERSION KIT**  
Fits: Most Mallory YL & YD 8 cyl.  
Distributors with clockwise and counter  
clockwise rotation

① 18-5297D Display Package



**18-5297  
ELECTRONIC  
CONVERSION KIT**  
For 4 Cyl. GM

① 18-5298 Display Package



**18-5298  
ELECTRONIC  
CONVERSION KIT**  
(with snap down cap)  
For: Most Prestolite V-8 Distributors

① 18-5299D Display Package





**18-5299  
ELECTRONIC  
CONVERSION KIT**  
(with screw down cap)  
For: Most Prestolite V-8 Distributors  
Use with 18-5403 style rotor

Not compatible with shift assist modules



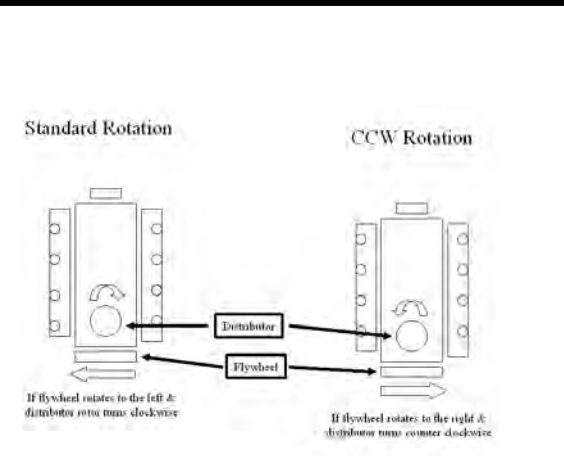

## FEATURES

- ★ *Distributors feature the Ignitor II ignition module with adaptive dwell control adjusts the spark timing over the entire RPM range to maximize performance*
- ★ *Upper roller bearing and oil impregnated bronze sintered bottom bushing are installed and aligned bored for accuracy for maximum durability*
- ★ *Machined heat treated gear with tight tolerances insures durability and consistent timing to maximize horsepower and performance. Complete with high dielectric strength cap and rotor for years of performance*

**18-5481  
HI-PERFORMANCE  
ELECTRONIC  
DISTRIBUTOR**  
Fits: Ford V-8 351 Windsor  
Replacement cap/rotor kit: 18-5266

**18-5482  
HI-PERFORMANCE  
ELECTRONIC  
DISTRIBUTOR**  
Fits: Ford V-8 351 Cleveland, 351M, 400,  
429 and 460 engines  
Replacement cap/rotor kit: 18-5266



**18-5483  
HI-PERFORMANCE  
ELECTRONIC  
DISTRIBUTOR**  
Fits: Chevrolet Marine Small and Big Block  
engines (Standard Deck Height)  
Replacement cap/rotor kit: 18-5266



**18-5477  
ELECTRONIC DISTRIBUTOR**  
Fits: Ford 302 V-8 engines



**18-5478  
ELECTRONIC DISTRIBUTOR**  
Chrysler LA series V-8 engines

APPLICATION BEGINS ON PAGE 750

① Items ending in "D" are Display Packaged - Regular number is Non-Display



**18-5479**  
**ELECTRONIC DISTRIBUTOR**  
GM V-8 engines-reverse rotation



**18-5476**  
**DISTRIBUTOR**  
Fits: GM V-6 engines with Delco EST ignition HEI



**18-5486**  
**ELECTRONIC DISTRIBUTOR**  
Replaces: Mallory YLM673AV  
Conventional Rotation  
For Chevrolet L4, 153 & 181 CID

—CONTAINS—

Part #	Description
18-5397	Distributor Cap
18-5488	Module
18-5404-1	Rotor



**18-5487**  
**ELECTRONIC DISTRIBUTOR**  
Replaces: Mallory YLM676AV  
Conventional Rotation  
For Chevrolet L6, 194, 230, 250, 292 CID

—CONTAINS—

Part #	Description
18-5488	Module
18-5404-1	Rotor



**18-5489**  
**ELECTRONIC DISTRIBUTOR**  
Replaces: Mallory YLM554CV  
Conventional Rotation  
For Ford V8 351W CID

—CONTAINS—

Part #	Description
18-5376	Distributor Cap
18-5488	Module
18-5404-1	Rotor



**18-5494-1**  
**ELECTRONIC DISTRIBUTOR**  
Replaces: Mallory YLM624AV  
Conventional Rotation  
For Chevrolet all V8 includes 482, 502, 540 CID  
(Except 348,409 & Tall Deck Big Block)

—CONTAINS—

Part #	Description
18-5376	Distributor Cap
18-5488	Module
18-5404-1	Rotor



**18-5495-1**  
**ELECTRONIC DISTRIBUTOR**  
Replaces: Mallory YLM512CV  
Conventional Rotation  
For Ford V8 302 CID

—CONTAINS—

Part #	Description
18-5376	Distributor Cap
18-5488	Module
18-5404-1	Rotor



**18-5496-1**  
**ELECTRONIC DISTRIBUTOR**  
Replaces: Mallory YLM567CV  
Conventional Rotation  
For Ford V8 351C — 460 CID

—CONTAINS—

Part #	Description
18-5376	Distributor Cap
18-5488	Module
18-5404-1	Rotor





**18-5498-1  
ELECTRONIC  
DISTRIBUTOR**

Replaces:  
Mallory YLM624BV  
Reverse Rotation  
For Chevrolet all V8 includes 482, 502, 540 CID  
(Except 348,409 & Tall Deck Big Block)

—CONTAINS—

Part #	Description
18-5376	Distributor Cap
18-5488	Module
18-5404-1	Rotor



**18-5484-1  
ELECTRONIC  
DISTRIBUTOR**

Replaces: Mallory YLE624AV

Late HEI

**Left Hand** Rotation

V8 262-454 & 502 except 348/409 and tall block engines

• Designed as a plug-in replacement for GM-style fuel injection system distributors

—CONTAINS—

Part #	Description
18-5354	Distributor Cap
18-5405	Rotor



**18-5485  
ELECTRONIC  
DISTRIBUTOR**

Replaces: Mallory YLE624BV

Late HEI

**Right Hand** Rotation

V8 262-454 & 502 except 348/409 and tall block engines

• Designed as a plug-in replacement for GM-style fuel injection system distributors

—CONTAINS—

Part #	Description
18-5354	Distributor Cap
18-5405	Rotor



**18-5309  
DISTRIBUTOR**

Contact Controlled

Replaces: 980902; Mallory YL512CV

For most Ford 302 CID V-8 Eng.

Uses: 18-5251 TUNE-UP KIT And 18-5376 CAP



**18-5312  
DISTRIBUTOR**

Contact Controlled

Replaces: 981080; Mallory YL554CV

For most Ford 351 CID V-8 Eng.

Uses: 18-5251 TUNE-UP KIT And 18-5376 CAP



**18-5313  
DISTRIBUTOR**

Contact Controlled

Replaces: 985560; Mallory YL624MW

For most GM V-8 Engs. (small & large blocks)

Uses: 18-5251 TUNE-UP KIT And 18-5376 CAP



**18-5315  
DISTRIBUTOR**

Contact Controlled

Replaces: Mallory YL673AV

For most GM 4 Cyl. Engines (120 & 140 HP)

Uses: 18-5251 TUNE-UP KIT And 18-5397 CAP



**18-5480  
COMPLETE  
IGNITION  
CONVERSION KIT**

Fits: GM SB & BB with Standard Deck Height

—CONTAINS—

Part #	Description
18-5472	Coil
18-8803-2	Wire Set
18-5483	Distributor

Model	Year	Cyl.	Distributor	Contact Set	Condenser	Dist. Cap	Rotor	Tune-Up Kit	Distributor	Electronic Conv. Kit
2.3L	1987-90	4	Mallory ①	18-5314	18-5338	18-5397	18-5404-1	18-5283 ②	—	—
2.3L	1990	4	Prestolite	18-5303	18-5347	—	18-5403	18-5260	—	—
2.5L	1981-86	4	982351 ④	18-5311	18-5345	18-5385	18-5418	18-5250 18-5268 ②	18-5486 ⑧ ① 18-5315 ⑩	18-5297 ①
3.0L	1982-90	4	982351 ④ ⑦	18-5311	18-5345	18-5385	18-5418	18-5250 18-5268 ②	18-5486 ⑧ ① 18-5315 ⑩	18-5297 ①
3.0L	1990-UP	4	—	—	—	18-5361	18-5406	—	—	—
3.8L	1981-86	6	982846, 983203 ② ⑥	18-5303	18-5347 ③	18-5353	18-5403	18-5262 18-5276 ②	—	—
4.3L	1985-90	6	— ② ⑥	18-5303	18-5347 ③	18-5353	18-5403	18-5262 18-5276 ②	—	—
4.3L	1991-92	6	986855 ②	N/A	N/A	18-5353	18-5403	N/A	—	N/A
5.0L (GM)	1981-88	8	983453 ①	18-5314	18-5338	18-5376	18-5404-1	18-5251 18-5271 ②	18-5494-1 ⑧ ① 18-5498-1 ⑨ ① 18-5313 ⑩	18-5296-2 ①
5.0L (GM)	1983-88	8	IBM-7013C ② ⑥	18-5303	18-5347 ③	18-5352	18-5403	18-5262 18-5275 ②	18-5494-1 ⑧ ① 18-5498-1 ⑨ ① 18-5313 ⑩	18-5299 ①
5.0L (GM)	1979-82	8	— ② ⑤	18-5303	18-5347 ③	18-5369	18-5407	18-5258 18-5277 ②	18-5494-1 ⑧ ① 18-5498-1 ⑨ ① 18-5313 ⑩	18-5298
5.0L (Ford)	1989-90	8	— ② ⑥	18-5303	18-5347 ③	18-5352	18-5403	18-5262 18-5275 ②	18-5309 ⑩ 18-5495-1 ⑧	—
5.0L	1991-92	8	— ② ⑥	N/A	N/A	18-5352	18-5403	N/A	18-5309 ⑩	18-5299
5.0L (Ford)	1993	8	Ford	N/A	N/A	—	18-5413	N/A	—	—
5.7L	1982-90	8	983453 ①	18-5314	18-5338	18-5376	18-5404-1	18-5251 18-5271 ②	18-5494-1 ⑧ ① 18-5498-1 ⑨ ① 18-5313 ⑩	18-5296-2 ①
5.7L	1982-90	8	IBM-7013C ② ⑥	18-5303	18-5347 ③	18-5352	18-5403	18-5262 18-5275 ②	18-5494-1 ⑧ ① 18-5498-1 ⑨ ① 18-5313 ⑩	18-5299 ①
5.7L	1991-92	8	— ② ⑥	N/A	N/A	18-5352	18-5403	N/A	18-5494-1 ⑧ 18-5498-1 ⑨ 18-5313 ⑩	N/A
5.8L (Ford)	1989-90	8	— ② ⑥	18-5303	18-5347 ③	18-5352	18-5403	18-5262 18-5275 ②	18-5489 ⑧ 18-5312 ⑩	18-5299
5.8L (Ford)	1991-92	8	— ② ⑥	N/A	N/A	18-5352	18-5403	N/A	18-5496-1 ⑧ 18-5312 ⑩	18-5299
5.8L (Ford)	1993	8	Ford	N/A	N/A	—	18-5413	N/A	—	—
7.5L	1987	8	— ② ⑤	18-5303	18-5347 ③	18-5369	18-5407	18-5258 18-5277 ②	18-5496-1 ⑧ 18-5312 ⑩	18-5298
7.5L	1987-89	8	— ② ⑥	18-5303	18-5347 ③	18-5352	18-5403	18-5262 18-5275 ②	18-5496-1 ⑧ 18-5312 ⑩	18-5299
88	1962-68	4	—	18-5157	18-5200	—	—	18-5001	—	—
90	1962-68	4	—	18-5157	18-5200	—	—	18-5001	—	—
100	1972-73	4	384720, 979856, 980500, 982351 ④	18-5311	18-5345	18-5385	18-5418	18-5250 18-5268 ②	18-5486 ① 18-5315 ⑩	18-5297
110	1964	4	— ④	18-5311	18-5345	18-5385	18-5418	18-5250 18-5268 ②	18-5486 ① 18-5315 ⑩	18-5297
120	1965-86	4	383581, 384258 ④	18-5311	18-5345	18-5385	18-5418	18-5250 18-5268 ②	18-5486 ① 18-5315 ⑩	18-5297 ①
140	1973-89	4	980500, 982351 ④	18-5311	18-5345	18-5385	18-5418	18-5250 18-5268 ②	18-5486 ① 18-5315 ⑩	18-5297 ①
150	1964-66	6	1110309, 22 ④	18-5310	18-5345	—	18-5419	—	—	—
155	1967-72	6	1110376 ④	18-5310	18-5344	—	18-5419	—	—	—
165	1972-76	6	980156 ④	18-5311	18-5345	18-5386	18-5418	18-5250 18-5269 ②	18-5487 ① 18-5495-1 ⑧	—
170	1974	8	— ② ⑤	18-5303	18-5347 ③	18-5369	18-5407	18-5258 18-5277 ②	18-5495-1 ⑧ 18-5309 ⑩	18-5298
175	1975-77	8	980902 ② ⑤	18-5303	18-5347 ③	18-5369	18-5407	18-5258 18-5277 ②	18-5495-1 ⑧ 18-5309 ⑩	18-5298
185	1967-68	8	381775 ①	18-5314	18-5338	18-5375	18-5411	18-5256 18-5272 ②	18-5495-1 ⑧ 18-5309 ⑩	—
185	1978-80	8	981659 ①	18-5314	18-5338 ③	18-5376	18-5404-1	18-5251 18-5271 ②	18-5495-1 ⑧ 18-5309 ⑩	18-5296-2
185	1978-80	8	982320 ② ⑤	18-5303	18-5347	18-5369	18-5407	18-5258 18-5277 ②	18-5495-1 ⑧ 18-5309 ⑩	18-5298
190	1974-77	8	980902 ② ⑤	18-5303	18-5347 ③	18-5369	18-5407	18-5258 18-5277 ②	18-5495-1 ⑧ 18-5309 ⑩	18-5298
200	1966	8	— ④	18-5310	18-5345	18-5384	—	18-5270 ②	18-5494-1 ⑧ 18-5498-1 ⑨ 18-5313 ⑩	—
200	1967-68	8	1111050, 058 053, 382127 ④	18-5310	18-5344	18-5384	—	18-5252 18-5270 ②	18-5494-1 ⑧ 18-5498-1 ⑨ 18-5313 ⑩	—
200	1979-88	8	981659 ①	18-5314	18-5338	18-5376	18-5404-1	18-5251 18-5271 ②	18-5494-1 ⑧ 18-5498-1 ⑨ 18-5313 ⑩	18-5296-2
200	1979-82	8	982320 ② ⑤	18-5303	18-5347 ③	18-5369	18-5407	18-5258 18-5277 ②	18-5494-1 ⑧ 18-5498-1 ⑨ 18-5313 ⑩	18-5298
210	1968-72	8	381775 ①	18-5314	18-5338	18-5375	18-5411	18-5256 18-5272 ②	18-5494-1 ⑧ 18-5498-1 ⑨	—
215	1971	8	— ①	18-5314	18-5338	18-5375	18-5411	18-5256 18-5272 ②	18-5494 ⑧ 18-5498 ⑨ 18-5313 ⑩	—
								18-5251	18-5494-1 ⑧	

N/A Not applicable

① Mallory  
 ② Prestolite  
 ③ For wire lead type, use 18-5345  
 ④ Delco

⑤ Models w/distributor cap hold down spring clip  
 ⑥ Models w/distributor cap hold down screw  
 ⑦ '90 Models point ignition only  
 ⑧ Electronic distributor (standard rotation)

⑨ Electronic distributor (counter rotation)  
 ⑩ Contact controlled distributor

① Does not include models with shift assist module  
 ② With distributor cap

Model	Year	Cyl.	Distributor	Contact Set	Condenser	Dist. Cap	Rotor	Tune-Up Kit	Distributor	Electronic Conv. Kit
225	1978	8	981659, 982320 ①	18-5314	18-5338	18-5376	18-5404-1	18-5271 ②	18-5498-1 ⑨ 18-5313 ⑩	18-5296-2
225	1972-76	8	381775 ①	18-5314	18-5338	18-5375	18-5411	18-5256 18-5272 ②	18-5494-1 ⑧ 18-5498-1 ⑨ 18-5313 ⑩	18-5296-2
230	1979-88	8	981659 ①	18-5314	18-5338	18-5376	18-5404-1	18-5251 18-5271 ②	18-5494-1 ⑧ 18-5498-1 ⑨ 18-5313 ⑩	18-5296-2
230	1979-82	8	982320 ② ⑤	18-5303	18-5347 ③	18-5369	18-5407	18-5258 18-5277 ②	18-5494-1 ⑧ 18-5498-1 ⑨ 18-5313 ⑩	18-5298
230 I.B.	1975-76	8	381775 ①	18-5314	18-5338	18-5375	18-5411	18-5256 18-5272 ②	18-5494-1 ⑧ 18-5498-1 ⑨ 18-5313 ⑩	—
235	1971	8	— ①	18-5314	18-5338	18-5375	18-5411	18-5256 18-5272 ②	18-5494-1 ⑧ 18-5498-1 ⑨ 18-5313 ⑩	—
235	1975-77	8	981080 ② ⑤	18-5303	18-5347 ③	18-5369	18-5407	18-5258 18-5277 ②	18-5494-1 ⑧ 18-5498-1 ⑨ 18-5313 ⑩	18-5296-2
240	1978	8	981080 ② ⑤	18-5303	18-5347 ③	18-5369	18-5407	18-5258 18-5277 ②	18-5494-1 ⑧ 18-5498-1 ⑨ 18-5313 ⑩	18-5296-2
245	1972-75	8	381775 ①	18-5314	18-5338	18-5375	18-5411	18-5256 18-5272 ②	18-5494-1 ⑧ 18-5498-1 ⑨ 18-5313 ⑩	—
250 I.B.	1970-74	8	— ①	18-5314	18-5338	18-5375	18-5411	18-5256 18-5272 ②	18-5494-1 ⑧ 18-5498-1 ⑨ 18-5313 ⑩	—
250	1979	8	981080 ② ⑤	18-5303	18-5347 ③	18-5369	18-5407	18-5258 18-5277 ②	18-5494-1 ⑧ 18-5498-1 ⑨ 18-5313 ⑩	18-5298
260 I.B.	1975-76	8	384193 ①	18-5314	18-5338	18-5375	18-5411	18-5256 18-5272 ②	18-5494-1 ⑧ 18-5498-1 ⑨ 18-5313 ⑩	—
260	1979-82	8	981659 ①	18-5314	18-5338	18-5376	18-5404-1	18-5251 18-5271 ②	18-5494-1 ⑧ 18-5498-1 ⑨ 18-5313 ⑩	18-5296-2
260	1979-82	8	982320 ② ⑤	18-5303	18-5347 ③	18-5369	18-5407	18-5258 18-5277 ②	18-5494-1 ⑧ 18-5498-1 ⑨ 18-5313 ⑩	18-5298
262 CID	1989	6	— ② ⑥	18-5303	18-5347 ③	18-5353	18-5403	18-5262 18-5276 ②	—	—
290 Jet	1974-75	8	— ①	18-5314	18-5338	18-5375	18-5411	18-5256 18-5272 ②	18-5494-1 ⑧ 18-5498-1 ⑨ 18-5313 ⑩	—
305 I.B.	1977-79	8	980680 ①	18-5314	18-5338	18-5375	18-5411	18-5256 18-5272 ②	18-5494-1 ⑧ 18-5498-1 ⑨ 18-5313 ⑩	—
305 I.B.	1980-82	8	981659, 982320 ①	18-5314	18-5338	18-5376	18-5404-1	18-5251 18-5271 ②	18-5494-1 ⑧ 18-5498-1 ⑨ 18-5313 ⑩	18-5296-2
350 I.B.	1977-79	8	981659 ①	18-5314	18-5338	18-5375	18-5411	18-5256 18-5272 ②	18-5494-1 ⑧ 18-5498-1 ⑨ 18-5313 ⑩	—
350 I.B.	1980-82	8	982320 ①	18-5314	18-5338	18-5376	18-5404-1	18-5251 18-5271 ②	18-5494-1 ⑧ 18-5498-1 ⑨ 18-5313 ⑩	18-5296-2
350 CID	1988-89	8	— ⑥	18-5314	18-5338	18-5376	18-5404-1	18-5251 18-5271 ②	—	—
350 CID	1988-89	8	— ② ⑤	18-5303	18-5347 ③	18-5352	18-5403	18-5275 ②	18-5313 ⑩ — 18-5313 ⑩	—
454 I.B.	1977-79	8	— ①	18-5314	18-5338	18-5375	18-5411	18-5256 18-5272 ②	18-5494-1 ⑧ 18-5498-1 ⑨ 18-5313 ⑩	—
454 I.B.	1980-82	8	981659, 982320 ①	18-5314	18-5338	18-5376	18-5404-1	18-5251 18-5271 ②	18-5494-1 ⑧ 18-5498-1 ⑨ 18-5313 ⑩	18-5296-2
460 CID	1988-89	8	— ② ⑥	18-5303	18-5347 ③	18-5352	18-5403	18-5262 18-5275 ②	—	—

N/A Not applicable

- ① Mallory
- ② Prestolite
- ③ For wire lead type, use 18-5345
- ④ Delco

- ⑤ Models w/distributor cap hold down spring clip
- ⑥ Models w/distributor cap hold down screw
- ⑦ '90 Models point ignition only
- ⑧ Electronic distributor (standard rotation)

- ⑨ Electronic distributor (counter rotation)
- ⑩ Contact controlled distributor
- Ⓜ Does not include models with shift assist module
- Ⓝ With distributor cap



**MP28890**  
**IGNITION LANAYARD**  
Replaces: 176288  
Fits: 1996 - Up



**MP28880\***  
**LANAYARD**  
Replaces: 432230  
Fits: 1995-Older



**18-5225**  
**SPARK PLUG WIRE KIT**  
Replaces: Mercury 84-99215A26, 84-813706A26  
Kit Includes 25 ft. Roll of 7 MM Hypalon Ignition Wire  
With a Metallic Core and a Large Assortment of Three  
Different End Fittings.



**18-5226**  
**IGNITION WIRE**  
 Metallic Core  
 100' Spool  
 7mm Hypalon

PKG. OF 10



**18-5224**  
**18-5224-90**  
**SPARK PLUG WIRE TERMINAL**  
 Replaces: Mercury 20121  
 OMC 510364

PKG. OF 10



**18-5750**  
**18-5750-90**  
**UNIVERSAL SPARK PLUG BOOT**  
 Supplied complete w/Terminal Connector  
 Replaces: OMC 581027, 580339



**18-5752**  
**UNIVERSAL SPARK PLUG BOOT**  
 8mm

**PREMIUM MARINE SPARK PLUG WIRE LEADS**



OE style boots provide a sealed barrier against heat, dirt and moisture.



**Premium Marine Wire Leads**  
 Magnetic Suppression Core  
 Manufactured for your specific application

- ★ Kevlar® core for maximum durability and long life.
- ★ Durable stainless steel wound conductor for maximum horsepower and engine performance.
- ★ Premium silicone jacketing and boots for the ultimate in high temperature protection.
- ★ Superior RFI suppression for the most sensitive electronic system.
- ★ Corrosion resistant stainless steel spark plug and distributor terminals for maximum conductivity.

Model	Ignition Type	Cyl.	O.E.M. #	Part #
2.3L	Conventional	4	503747	18-8807-1
100/ 110/ 120/ 2.5L/ 140/ 3.0L/ 140 Jet	Conventional	4	503748	18-8800-1
3.0L/ HO	EST Electronic	4	503749	18-8814-1
3.0L/ HO	EST Electronic	4	503749	18-8811-1
3.0L/ HO	EST Electronic	4	503749	18-8841-1
4.3L	EST Electronic	6	503751	18-8810-1
3.8L/ 4.3L	Conventional	6	503750	18-8801-1
370 (King Cobra)/ 454/ 7.4L/ 502/ 8.2L	Conventional	8	503752, 503755	18-8803-2
175/ 185/ 190/ 200/ 5.0L - 5.7L (GM)	Conventional	8	503752, 503755 ①	18-8803-2, 18-8823-1 ①
225/ 230/ 235/ 240/ 250/ 260	Conventional	8	503752, 503755 ①	18-8803-2, 18-8823-1 ①
5.0L - 5.8L EFI (Ford)	EST Electronic	8	503754	18-8820-1
5.0L - 5.8L (Ford)	Conventional	8	503753	18-8842-1
460 (King Cobra)	Conventional	8	N/A	18-8825-1
8.1L / 496	Distributorless	8		18-8838-1
7.4L / 8.2L V8	DDS	8	503756	18-8843-1

① Models with Mallory side terminal caps

Engine	Cyl.	Year	Kit	Engine	Cyl.	Year	Kit
2.3L	4	1987-90	18-8807-1	185	8	1978-80	18-8802-1
2.5L	4	1982-86	18-8800-1	190	8	1975-77	18-8805-1
3.0L ⑧	4	1982-90	18-8800-1	200	8	1979-81	18-8802-1
3.0L/3.0L H.O.	4	1991-92	18-8814-1	225	8	1978	18-8802-1
3.0L/3.0L H.O. ⑩	4	1990-94	18-8841-1	225	8	1976	18-8802-1
2.5/3.0L 110-140hp ⑩	4	1964-90	18-8811-1	230	8	1979-81	18-8802-1
3.8L	V6	1981-86	18-8801-1	230 IB LH	8	1976	18-8802-1
4.3L ⑨	V6	1985-90	18-8801-1	230 IB LH	8	1976	18-8802-1
4.3L ⑩	V6	1994	18-8810-1	235	8	1975-77	18-8805-1
5.0L	8	1982-88	18-8802-1	240	8	1978	18-8805-1
5.0L	8	1989-90	18-8806-1	250	8	1979	18-8805-1
5.7L	8	1982-89	18-8802-1	260	8	1979-81	18-8802-1
5.7L King Cobra	8	1988	18-8802-1	260 IB LH	8	1976	18-8802-1
5.8L	8	1989-90	18-8842-1	260 IB LH	8	1976	18-8802-1
7.4L ②	8	1991	18-8843-1	262 King Cobra	V6	1989	18-8801-1
7.4L/8.2L	8	1992-94	18-8843-1	305 CID IB LH ⑥	8	1979-82	18-8802-1
7.5L	8	1987	18-8803-2	305 CID IB RH ⑤	8	1977-82	18-8802-1
7.5L King Cobra	8	1987	18-8803-2	305 CID IB RH ⑦	8	1979-82	18-8802-1
80	4	1968-69	18-8800-1	305 CID IB LH ⑤	8	1977-82	18-8802-1
100	4	1972-73	18-8800-1	350 CID IB RH ⑤	8	1977-82	18-8802-1
110	4	1964	18-8800-1	350 CID IB RH ⑦	8	1979-82	18-8802-1
120 ①	4	1965-74	18-8800-1	350 King Cobra	8	1989	18-8802-1
120 ②	4	1974-81	18-8800-1	370 King Cobra	8	1988	18-8803-2
140 ①	4	1973-74	18-8800-1	454 CID IB	8	1979-82	18-8802-1
140 ②	4	1974-81	18-8800-1	460 King Cobra	8	1988-89	18-8803-2
140 Jet	4	1973	18-8800-1	8.1L / 496 ①	8	2000 & up	18-8838-1
175	8	1975-77	18-8805-1				

③ Priced per Package



Display Package

**SPARK PLUG WIRE SETS**  
 8mm

- ① 1974:FF and R only
- ② 1974:Model R1 only
- ③ 1975:Model A1 only
- ④ Model M only
- ⑤ Models w/o closed cooling
- ⑥ V-Drive model w/ closed cooling
- ⑦ Direct Drive Model w/ closed cooling
- ⑧ 1990 Models 302BMRPWS and 302BPRPWS
- ⑨ 1990 (2 BBL) carb
- ⑩ Delco Digital & EST Ignition
- ① Distributorless Ignition
- ② F suffix models only



**18-5923**  
**STARTER, PMGR, FORD**  
 PMGR Replacement for 18-5903;  
 302CID, 351CID Ford Engines



**18-5927**  
**STARTER, PMGR, FORD**  
 PMGR Replacement for 18-5917, 2.3L  
 Ford Starter.



**18-6834**  
**STARTER**  
 Replaces: GM Engines Universal  
 Used on Buick, Chevrolet, Oldsmobile, and Pontiac Race  
 Engines



**18-6835**  
**STARTER**  
 Replaces: GM Engines Universal  
 Used on Buick, Chevrolet, Oldsmobile, and Pontiac Race  
 Engines



**18-6270**  
**PERMANENT MAGNET I/O STARTER**  
 Replaces: 988013,  
 984536  
 • Permanent Magnet  
 • Heavy Duty  
 • 12 Volt  
 • 2 Bolt Mount  
 • 1 Threaded Hole  
 • CW Rotation  
 • SAE J1171  
 For: 460 Ford, OMC King Cobra



**18-5919**  
**STARTER**  
 Permanent magnet I/O starter  
 For: Late model GM - 12 3/4" flywheel  
 Replaces: 988217  
 Replacement Solenoid: 18-6287  
 SAEJ1171  
 1.7 KW



**18-5920**  
**STARTER**  
 Permanent Magnet  
 For: 5.0 & 5.8 litre Ford engines.  
 Replaces: 987811, 3854190  
 Replacement Solenoid: 18-6291

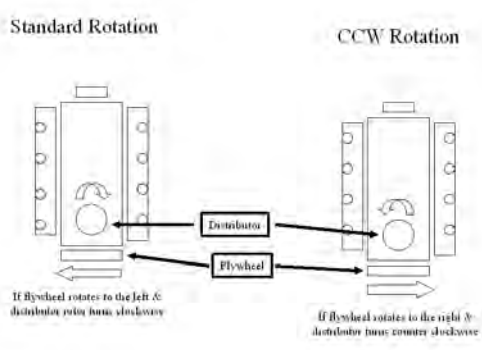

**18-6276**  
**STARTER**  
 Replaces: 984536, 988013  
 • 12 Volt  
 • CW Rotation  
 • Threaded Top Hole in Housing  
 • 460 Ford, OMC King Cobra



**18-5911**  
**STARTER**

**(Heavy-Duty) (No Core)**  
 For GM engines, bottom mount straight across bolt pattern.  
 Standard rotation clockwise. 100-245 HP — 1970-1978 (GM)  
 Replaces: 981078, 982121, 983444, 983790, 985966  
 Replacement Solenoid: 18-5837  
 SAEJ1171



**18-5900**  
**REMANUFACTURED**  
**STARTER**



**18-5907**  
**STARTER**

**(Heavy-Duty) (No Core)**  
 Top mount rear entry starter for opposite rotation  
 GM and Ford engines clockwise.  
 Replaces: 981289, 982202  
 Replacement Solenoid: 18-5837  
 SAEJ1171



**18-5901**  
**REMANUFACTURED**  
**STARTER**





**18-5908  
STARTER**

**(Heavy-Duty) (No Core)**  
**Top mount rear entry starter for standard rotation GM and Ford engines. Counter-clockwise.**  
 Replaces: 981288, 982195, 984982, 986007  
 Replacement Solenoid: 18-5837  
**SAEJ1171**



**18-5902  
REMANUFACTURED  
STARTER**



**18-5910  
STARTER**

**(Heavy-Duty) (No Core)**  
**Small block GM V-6 & V-8 Engine with 14 1/4" flywheel and bottom mount, offset bolt pattern. For standard rotation engines. Clockwise. 1986-1992 - V-6, V-8 (GM) and 1990-1993 OMC King Cobra**  
 Replaces: 984456, 986505  
 Replacement Solenoid: 18-5837  
**SAEJ1171**



**18-5905  
REMANUFACTURED  
STARTER**



**18-5917  
STARTER**  
 Replaces: 984628  
**3 bolt mount - Late style 4" diameter case. Standard rotation engines For: Late model Ford V-8. Replacement Solenoid: 18-5801**



**18-5903  
STARTER**  
**(No Core) (Clockwise)**  
**Bottom mount, two bolt pattern for standard rotation. Ford engines. Clockwise**  
 Replaces: 980803, 981821  
 Replacement Solenoid: 18-5801



**18-5913  
STARTER**  
**(Clockwise)**  
**Delco permanent magnet gear reduction 2 bolt starter 12V - 11 Tooth - Offset bolt pattern. Fits: Chevy Engines with 14" flywheels. 1.7 KW**  
 Replaces: 3854751 SAEJ1171  
 Replacement Solenoid: 18-6287



**OMC STERNDRIVE/OMC COBRA STARTERS**

Engine	Year	Starter #	Engine	Year	Starter #	Engine	Year	Starter #
3.0L	1982-92	18-5900	170	1974	18-5903	245	1972-75	18-5900
5.0L	1982-86	18-5900 ④	175	1975-77	18-5903	245 JET	1972-74	18-5900
5.0L	1986-88	18-5905 ⑤	185	1967-68,		250	1979	18-5903
2.5L	1982-86	18-5900		1978-80	18-5900	260	1975-76	18-5902 ①
3.8L	1981-86	18-5900	190	1974-77	18-5903	260	1975-76	18-5901 ②
4.3L	1985-86	18-5900	200	1966-68,		260	1979-81	18-5900
4.3L	1986-92	18-5905		1979-81	18-5900	262 CID	1989	18-5905
5.7L	1982-86	18-5900	210	1968-72	18-5900 ①	290	1975	18-5902 ③
5.7L	1986-92	18-5905	215	1971	18-5900	305 CID	1977-80,82	18-5902 ①
100	1972-73	18-5900	225	1972-76,		305 CID	1977-80,82	18-5901 ②
110	1964	18-5900		1978	18-5900 ①	350 CID	1977-80,82	18-5902 ①
120	1965-81	18-5900	230	1975-76	18-5902 ①	350 CID	1977-80,82	18-5901 ②
140	1973-81	18-5900	230	1975-76	18-5901 ②	350 CID	1988-91	18-5905
140 JET	1973	18-5900	230	1979-81	18-5900	370 CID	1988	18-5902
150	1964-66	18-5900	235	1971	18-5900	454 CID	1977-80,82	18-5902 ①
155	1967-72	18-5900	235	1975-77	18-5903	454 CID	1977-80,82	18-5901 ②
165	1972-76	18-5900	240	1978	18-5903	454 CID	1990-92	18-5905
						502 CID	1992	18-5905

① Standard rotation engines.

② Opposite (Reverse) rotation engines.

③ Engines with model number suffix "R2" or "R3"

④ '86 Model engines with model number suffix "WB"

⑤ '86 Model engines with model number suffix "XS"



**18-5717  
STARTER BRUSH SET**  
Replaces:  
Delco 1984462



**18-5811  
STARTER SOLENOID**  
Replaces: 3850216  
For: PG 260 series starters, GM V6 & V8 (1983-Up)



**18-5801  
SOLENOID**  
Replaces: 985064  
**Grounded Base**

① 18-5801D Display Package

"I" Terminal  
"S" Terminal



**18-5803  
SOLENOID**  
Replaces: 979774

"S" Terminal  
"I" Terminal

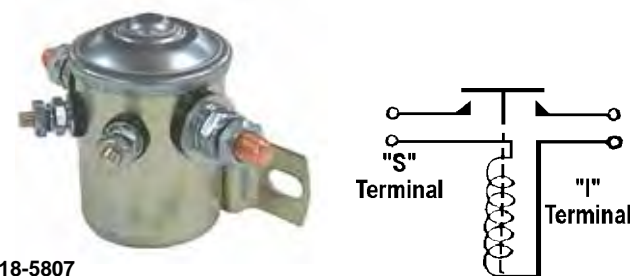

**18-5807  
SOLENOID**  
Replaces: 378444  
Prestolite SAW4206

"S" Terminal  
"I" Terminal



**18-6291  
SOLENOID**  
Replaces: 3854194 and Volvo Penta 3854194-2  
Fits: Ford Gear Reduction Starters on Late Model 5.0L, 5.8L, OMC and Volvo Penta



**18-5814  
SOLENOID**  
Replaces: 172869, 581528  
12 Volt, Isolated Base



**18-5808  
SOLENOID**  
Replaces: 395419, 582708

③ 18-5808D Display Package

"S" Terminal  
"I" Terminal



**18-5812  
SOLENOID**  
Replaces: 985063

③ 18-5812D Display Package

"S" Terminal  
"I" Terminal



**18-5837  
SOLENOID**  
Replaces: 985799, 986620  
Delco 1114531

"I" Terminal  
"S" Terminal



**18-5838  
SOLENOID**  
Replaces:  
Delco 1114356, 1114458

"I" Terminal  
"S" Terminal

**BATTERY CABLES**  
Gauge cable with soldered lug terminals on each end to accept a 3/8" stud

Part No.	Size	Color	Gauge	Part No.	Size	Color	Gauge
BC88523	2'	red	4	BC88563	6'	red	2
BC88533	2'	black	4	BC88573	6'	black	2
BC88543	4'	red	2	BC88583	8'	red	1
BC88553	4'	black	2	BC88593	8'	black	1

① Items ending in "D" are Display Packaged - Regular number is Non-Display

**STRINGER SOLENOID APPLICATION**

HP	Year	Starter Brush	Starter Mounted Solenoid	Starter Solenoid	Tilt Solenoid	Trim Solenoid
80	1969	—	N/A	18-5808	N/A	18-5808
88	1964	—	N/A	18-5807	N/A	18-5807
90	1965-71	—	N/A	18-5808	N/A	18-5808
100	1972-73	18-5717	18-5838	18-5803	N/A	18-5803
110	1964	18-5717	18-5838	18-5807	N/A	18-5807
120	1965-71	18-5717	18-5838	18-5808	N/A	18-5808
120	1972-77	18-5717	18-5838	18-5803	18-5803	18-5803
120	1978-81	18-5717	18-5838	—	—	—
140	1973-77	18-5717	18-5838	18-5803	18-5803	18-5803
140	1978-81	18-5717	18-5838	—	—	—
145	① 1973	—	18-5838	18-5803	N/A	N/A
150	1964	18-5717	18-5838	18-5807	N/A	18-5807
150	1965-66	18-5717	18-5838	18-5808	N/A	18-5808
155	1967-72	18-5717	18-5838	18-5808	N/A	18-5808
165	1972-76	18-5717	18-5838	18-5803	18-5803	18-5803
170	1974	—	N/A	18-5801	N/A	18-5803
175	1975-78	—	N/A	18-5801	N/A	18-5803
185	1967-68	18-5717	18-5838	18-5808	N/A	18-5808
185	1978-80	18-5717	18-5838	—	—	—
190	1974-78	—	N/A	18-5801	N/A	18-5803
200	1966-78	18-5717	18-5838	18-5808	N/A	18-5808
200	1979-81	—	18-5838	—	—	—
210	1968-70	18-5717	18-5838	18-5808	N/A	18-5808
210	② 1970-72	18-5717	18-5838	18-5808	N/A	N/A
215	1971	18-5717	18-5838	18-5808	N/A	18-5808
225	1972	18-5717	18-5838	18-5808	N/A	18-5808
225	1973	18-5717	18-5838	18-5803	N/A	18-5808
225	1974-76	18-5717	18-5838	18-5803	N/A	18-5803
225	1978	18-5717	18-5838	—	—	—
225	② 1973-74	18-5717	18-5838	18-5808	N/A	N/A
230	② 1975-76	18-5717	18-5838	18-5803	N/A	N/A
230	1979-81	18-5717	18-5838	—	—	—
235	1971	18-5717	18-5838	18-5808	N/A	18-5808
235	1975-78	—	N/A	18-5801	N/A	18-5803
245	1972	18-5717	18-5838	18-5808	N/A	18-5808
245	1973	18-5717	18-5838	18-5803	N/A	18-5808
245	1974-75	18-5717	18-5838	18-5803	N/A	18-5803
245	① 1972-75	18-5717	18-5838	18-5808	N/A	N/A
250	② 1970-74	—	18-5838	18-5808	N/A	N/A
260	② 1975-76	18-5717	18-5838	18-5803	N/A	N/A
260	1979-81	18-5717	18-5838	—	—	—
290	① 1974-75	18-5717	18-5838	18-5808	N/A	N/A
305	② 1977-82	18-5717	18-5838	—	N/A	N/A
350	② 1977-82	18-5717	18-5838	—	N/A	N/A
454	② 1977-82	18-5717	18-5838	—	N/A	N/A
2.5	1982	18-5717	18-5838	—	—	—
2.5	1983-86	18-5717	18-5837	—	—	—
3	1982	18-5717	18-5838	—	—	—
3	1983-86	18-5717	18-5837	—	—	—
3.8	1981-82	18-5717	18-5838	—	N/A	—
3.8	1983-86	18-5717	18-5837	—	N/A	—
4.3	1985-86	18-5717	18-5837	—	N/A	—
5	1982	18-5717	18-5838	—	—	—
5	1983-86	18-5717	18-5837	—	—	—
5.7	1982	18-5717	18-5838	—	—	—
5.7	1983-86	18-5717	18-5837	—	—	—

① Jet Drive      ② Inboard

**OMC COBRA SOLENOID APPLICATION**

HP	Year	Starter Brush	Starter Mounted Solenoid	Starter Solenoid	Trim Solenoid
262	1989	N/A	18-5837	18-5812	N/A
350	1988	N/A	18-5837	18-5812	18-5812
350	1989	N/A	18-5837	18-5812	N/A
350	1990-91	N/A	18-5837	18-5801	N/A
351	1992	—	—	18-5801	N/A
370	1988	N/A	—	18-5812	18-5812
370	1989	N/A	—	18-5812	N/A
454	1990	—	—	18-5801	N/A
454	1991-92	N/A	18-5837	18-5801	N/A
460	1989-90	N/A	—	18-5801	N/A
502	1992	N/A	18-5837	18-5801	N/A
2.3	1987-88	N/A	—	18-5801	18-5812
2.3	1989-90	N/A	—	18-5801	N/A
2.5	1986	18-5717	18-5837	18-5812	18-5812
3	1986-88	18-5717	18-5837	18-5812	18-5812
3	1989-90	18-5717	18-5837	18-5812	N/A
3	1991-92	18-5717	18-5837	18-5801	N/A
4.3	1986-88	18-5717	18-5837	18-5812	18-5812
4.3	③ 1989-90	18-5717	18-5837	18-5812	N/A
4.3	④ 1990-92	18-5717	18-5837	18-5801	N/A
5	1986-88	18-5717	18-5837	18-5812	18-5812
5	1989-92	18-5717	—	18-5801	N/A
5.7	1986-88	18-5717	18-5837	18-5812	18-5812
5.7	1989	18-5717	18-5837	18-5812	N/A
5.7	1990-92	18-5717	18-5837	18-5801	N/A
5.8	1989-92	N/A	—	18-5801	N/A
7.5	1987	18-5717	—	18-5801	18-5812

③ 1990 Models with 2 barrel carbs      ④ 1990 Models with 4 barrel carbs.



**18-5711**  
**VOLTAGE REGULATOR**  
 Replaces: 383440  
 Prestolite: VSH-6201 AFY  
 12 Volt



Years	Model	Alternator or Generator
1964-66	110, 150 HP	ALK-6222, A, AYS
1967-81	80, 90, 120, 140, 155, 165, 175 185, 190, 200, 210, 225, 230, 235, 250, 260 HP & 305, 350, 454 CID	ALK-6222, A, AY, Y, AYS ANK-65201S, Y ALK-6210, A

**18-6261**  
**ALTERNATOR**  
 Replaces: 987774, 3857561,  
 3854182, 3854809, 3856600, 3860171  
 Fits: 3.0L, 4.3L, 5.7L, 7.4L (1995-98), 5.0L, 5.8L, 8.2L  
 (1993-98)  
 For: Delco



**18-6260**  
**ALTERNATOR**  
 OMC Cobra 12 Volt, 51 Amp, Internal  
 Regulator, Negative Ground, Single  
 Groove Pulley For : Prestolite/Motorola



**18-6841**  
**ALTERNATOR**  
 Replaces: 983836, 988247  
 For: 37-63A Marine Applications



**18-6842**  
**ALTERNATOR**  
 Replaces: 983424, 836, 247  
 For: 37-63A Marine Applications



**18-5957**  
**ALTERNATOR**



**18-5951**  
**ALTERNATOR**  
 Remanufactured



Replaces: 982364, 983424, 983836, 985466, 986008  
 ( 3-Wire ) ( No Core ) ( 68 AMP )

Replaces Mando, Motorola and original equipment Delco. Uses same electrical  
 connections and mounting method. Equipped with fan and drive pulley. SAEJ1171



**18-2192**  
**ELECTRIC SHIFT CABLE**  
 Replaces: 379628

**ELECTRIC SHIFT CABLE APPLICATION**

Year	HP
1964	110 ②, 150
1965	120 ①, 150
1966	120 ①, 150, 200
1967	120 ①, 155, 185, 200
1968	120, 155, 185, 200, 210
1969-70	120, 155, 210
1971	120, 155, 215, 235
1972-73	100, 120, 155, 165, 225, 245
1974	120, 140, 165, 170, 190, 225, 245
1975	120, 140, 165, 175, 190, 225, 235, 245
1976	120, 140, 165, 175, 190, 225, 235
1977	120, 140, 175, 190, 235

① Heavy Duty    ② SU12M, SUE 12M

③ **18-5705D**

**18-5705**  
**POWER**  
**TRIM RELAY**

Replaces: 582472,  
 584416, 586224  
 5 Terminal



Single Pull - Double Throw - 12 Volt  
 Open Contact: 40 Amps Resistive  
 30 Amps Conductive  
 Closed Contact: 20 Amps Resistive  
 15 Amps Conductive



**18-6257**  
**TILT/TRIM MOTOR**  
 Replaces: 983195, 982957  
 1982-85 Models with hydraulic engine lifts for  
 pump assembly



**18-6754**  
**TILT MOTOR**  
 Replaces: 382138  
 Prestolite ETK 4102, ETK 4001, ETK 4101  
 (All Models 1963-77)



**18-6755**  
**TILT MOTOR**  
 Replaces: 982706, 982058  
 Prestolite EVD 4001, EVD 4002  
 (All Models Except 2.5L, 3.0L - 1978-85)



**18-6764  
TILT/TRIM MOTOR**  
Replaces: 982073, 983318, 982069  
For: OMC Stringer and Cobra "Select Trim" 3-Wire Connection 1979-85 Stern Drive ( 2.5L & 3.0L)

PKG. OF 5



**18-6779  
TRIM MOTOR**  
Replaces: 986280, 3853945  
For: 1990 & 1994 King Cobra Trim System

**NEW**



**18-6814  
TRIM MOTOR**  
Replaces: 984356  
OMC Cobra

**NEW**



**18-6816  
TRIM MOTOR**  
Replaces: 172588, 173944  
Fits: 40, 50, 70, and 75HP with short shaft

**NEW**



**18-6823  
WIRING HARNESS**  
Replaces: Universal  
Converts 3-wire Tilt and Trim motors to 2-Wire design



**18-6950  
18-6950-9<sup>Ⓢ</sup>  
POWER TILT FUSE  
(50 amp)**  
Replaces: 982019



**18-9802  
TIMING LIGHT**  
Self-powered accurate up to 10,000 RPM's



**18-7601  
AIR CHARGE  
TEMPERATURE SENSOR**  
Replaces: 3854158  
8 cyl  
5.0L, 5.8 L, EFI (1994-96)



**18-7684  
MAP SENSOR**  
Replace: 3850396  
For: 4.3L TBI(1996-98), 5.0L TBI(1998), 5.7L TBI(1996-98), 7.4L(1995-98), 8.2L(1998)



**18-7677  
KNOCK SENSOR**  
Replace: 3850357



**18-7679  
KNOCK SENSOR**  
Replace: 3854905



**18-7703  
KNOCK SENSOR**  
Replace: 3854512



**18-7689  
FUEL INJECTOR**  
Replace: 3855182



**18-7650  
FUEL PRESSURE REGULATOR**  
Replaces: 987995  
8 cyl  
5.0L, 5.8 L, EFI (1993)



**18-7627  
INTAKE MANIFOLD**  
Small-block GM with vortec cylinder heads



**18-7628  
INTAKE MANIFOLD**  
Small-block GM with vortec cylinder heads with brass lined water jackets

Ⓢ Priced per Package

**ALL SIERRA CARBURETORS INCLUDE BASE GASKET**

- Precision remanufactured to meet or exceed OEM specifications
- Re-calibrated and re-engineered to maximize fuel efficiency and performance
- All carburetors are flow tested throughout the entire throttle range
- Fuel mixture and idle settings are pre-set to ensure that only minor idle and choke adjustments are necessary during installation
- All bases are resurfaced and throttle shaft bushings replaced



**18-7635  
CARBURETOR  
(REMANUFACTURED)**  
300 CFM Holley 2V



**18-7636  
CARBURETOR  
(REMANUFACTURED)**  
500 CFM Holley 2V



**18-7637  
CARBURETOR  
(REMANUFACTURED)**  
600 CFM Holley 4V



**18-7638  
CARBURETOR  
(REMANUFACTURED)**  
600 CFM Holley 4V-side inlet



**18-7640  
CARBURETOR  
(REMANUFACTURED)**  
Universal Q-jet with electric choke



**18-7605-1  
CARBURETOR**  
4 Barrel Rochester  
Replaces: 382821, 383766, 384194  
**Remanufactured**



**18-7608-1  
CARBURETOR**  
2 Barrel Rochester  
Replaces: 381668, 980528, 982219, 982217  
**Remanufactured**



**18-7609-1  
CARBURETOR**  
2 Barrel Rochester  
Replaces: 382733, 980530,  
982217, 984180, 381494, 772831  
**Remanufactured**



**18-7615-1  
CARBURETOR**  
4 Barrel Rochester  
Replaces: 981705, 982223,  
983855, 981359, 981564,  
985822, 981803, 981428  
**Remanufactured**



**18-7615N  
Q-JET CARBURETOR**  
Replaces: 1347-816373A4,  
1347-804624R1,  
1347-804624R02

**OMC STERN DRIVE CARBURETOR APPLICATION**

Model	Year	OMC Carburetor #	MFG Carburetor #	Carb Code & Model	Part #
80	1968-69	382733, 772831	7028085, 17059053, 17086064, 17087311	R2, 2GC	18-7609-1
90	1970-71	382733, 772831	7028085, 17059053, 17086064, 17087311	R2, 2GC	18-7609-1
120 (400 Series)	1972-86	381668, 980528, 982219	7044186, 17059056	R2, 2GC	18-7608-1
140 (400 Series)	1973-85	979821, 980530, 982217, 984180	17086107	R2, 2GC	18-7608-1
155	1967-72	772831	7026180	R2, 2GC	18-7609-1
165	1972-76	979821, 980530	17086107	R2, 2GC	18-7609-1
185	1989	984180	17086064	R2, 2GC	18-7609-1
200	1966-68	381494	7025187	R2, 2GC	18-7609-1
210	1968-72	382821, 383766	7028282, 7028280	R4, 4MV	18-7605-1
215, 225, 230	1971-76	382821	7028280	R4, 4MV	18-7605-1
230 (800 Series)	1979-89	981705, 982223	17057290, 17059285, 17059286, 17086117	R4, 4MV	18-7615-1
245	1972-75	384194	7040284	R4, 4MV	18-7605-1
250	1970-74	384194	7040284	R4, 4MV	18-7605-1
260 (800 Series)	1975-76	384194	7040284	R4, 4MV	18-7605-1
260 (800 Series)	1979-89	982223	17057290, 17059285, 17059286, 17086117	R4, 4MV	18-7615-1
2.5L, 3.0L	1982-86	982219, 982217	17059056, 17059053	R2, 2GC	18-7608-1
3.0L	1987-90	984180	17086064	R2, 2GC	18-7608-1
3.8L (4V)	1979-85	983855	17082515, 17085010	R4, 4MV	18-7615-1
4.3L (4V)	1979-89	983855	17082515, 17085010	R4, 4MV	18-7615-1
5.0L (GM)(4V)	1979-89	982223	17057290, 17059285, 17059286, 17086117	R4, 4MV	18-7615-1
5.7L (4V)	1979-89	982223	17057290, 17059285, 17059286, 17086117	R4, 4MV	18-7615-1
305, 350 CI, I/B	1977-83	981359, 982215, 981564, 982223	17057290, 17059285, 17059286, 17086117	R4, 4MV	18-7615-1
350 (4V)	1988-89	985822	17057290, 17059285, 17059286, 17086117	R4, 4MV	18-7615-1
454 CI, I/B	1977-78	981803, 981428	17057290, 17059285, 17059286, 17086117	R4, 4MV	18-7615-1



**18-7017  
CARB KIT**  
Replaces: 985052  
235 (5.8L Ford) 1989 7.5L/460 C.I. 1987-89  
(Contains Non-adjustable needles and seats)



**18-7018  
CARB KIT**  
Replaces: 981790, 982352  
350 C.I. Inboard 1977-78



**18-7070  
CARB KIT**  
Replaces: 383615, 982384



**18-7071  
CARB KIT**  
Replaces: 380186



**18-7072  
CARB KIT**  
Replaces: 979659, 384743



**18-7080  
CARB KIT**  
Replaces: 979719



**18-7081  
CARB KIT**  
Replaces: 982537, 982538,  
(Contains adjustable needles and seats)



**18-7086  
CARB KIT**  
Replaces: 984487



**18-7095  
CARB KIT**  
Replaces: 983864, 383918



**18-7096**  
**CARB KIT**  
Replaces: 982539, 85R-4541  
(Contains adjustable needles and seats)



**18-7235**  
**CARB KIT**  
Replaces: 986783



**18-7236**  
**CARB KIT**  
Replaces: 986782



**18-7237**  
**CARB KIT**  
Replaces: 986784, 986799



**18-7238**  
**CARB KIT**  
Replaces: 986796



**18-7239**  
**CARB KIT**  
Replaces: 986800

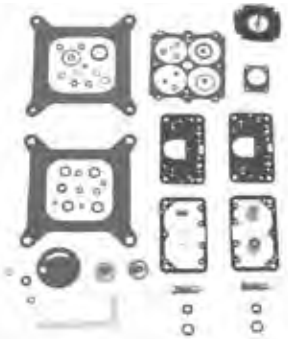

**18-7241**  
**CARB KIT**  
Replaces: 986804



**18-7242**  
**CARB KIT**  
Replaces: 987313



**18-7243**  
**CARB KIT**  
Replaces: 987315



**18-7244**  
**CARB KIT**  
Replaces: 987317



**18-7245**  
**CARB KIT**  
Replaces: 987319



**18-7246**  
**CARB KIT**  
Replaces: 987438, 987440, 987485



**18-7727**  
**CARB KIT**



**18-7729**  
**CARB KIT**



**18-7730**  
**CARB KIT**

APPLICATION BEGINS ON NEXT PAGE



**18-7200**  
**FLOAT**  
 (Alcohol Resistant)  
 Replaces: 381389  
 Brass



**18-7201**  
**FLOAT**  
 (Alcohol Resistant)  
 Replaces: 383087, 983871  
 Brass



**18-7206**  
**NITROPHYL FLOAT**  
 Nitrophyl

**CARBURETOR KIT/FLOAT APPLICATION**

Model	Years	Mfg. Code	Carb. Model	Carb. Kit	Float
80	1968-69	R2	2GC	18-7070	18-7200
90	1970-71	R2	2GC	18-7070	18-7200
100	1972-73	C1	RBS	18-7080	—
110	1964	R1	BC	18-7071	—
120	1965-71 (Dual Carb)	C1	RBS	18-7080	—
120	1972-85	R2	2GC	18-7070	18-7200
140	1973-85	R2	2GC	18-7070	18-7200
150	1964-65	R1	BC	18-7071	—
150	1965-66	C1	RBC	18-7080	—
155	1967-72	R2	2GC	18-7070	—
165	1972-76	R2	2GC	18-7070	18-7200
170	1974	H2	2300	18-7081	18-7206
175	1975-77	H2	2300	18-7081	18-7206
185	1978-81	R2	2GE	18-7086	18-7200
185	1989	H2	2300	18-7081	18-7206
190	1974-77	H2	2300	18-7081	18-7206
200	1966-68	R2	2GC,V	18-7070	—
200	1979-85	R2	2GE	18-7086	18-7200
200	1989	H2	2300	18-7081	18-7206
210	1968-72	R4	4MV	18-7072	18-7201
215	1971	R4	4MV	18-7072	18-7201
225	1972-76	R4	4MV	18-7072	18-7201
230	1975-76	R4	4MV	18-7072	18-7201
230	1979-89	R4	4MV	18-7095	18-7201
235	1975-77	H4	4160	18-7096	18-7206
235	1989	H4	4160	18-7017	—
240	1978	H4	4160	18-7017	—
245	1972-75	R4	4MV	18-7072	18-7201
250	1970-74	R4	4MV	18-7072	18-7201
250	1979	H4	4160	18-7017	—
260	1975-76	R4	4MV	18-7072	18-7201
260	1979-89	R4	4MV	18-7095	18-7201
290 JET	1974-75	R4	4MV	18-7072	18-7201
2.3L	1987-89	R2	2GE	18-7086	18-7200
2.5L	1982-85	R2	2GC	18-7070	18-7200
2.5L	1986-90	R2	2GE	18-7086	18-7200
2.5L	1986	R2	2GC	18-7070	18-7200
3.0L ⑥	1982-90	R2	2GC	18-7070	18-7200
3.0L/3.0L H.O.	1991-92	H-2	2300	18-7246	N/A
3.8L	1979-85	R2	2GE	18-7086	18-7200
4.3L	1986-89	R2	2GE	18-7086	18-7200
4.3L	1979-89	R4	4MV	18-7095	18-7201
4.3,4.3 H.O. ②	1990-92	H2	2300	18-7238	N/A
4.3,4.3 H.O. ③	1990-92	H4	4160	18-7237	N/A
4.3/262 ②	1989	R2	2GE	18-7086	18-7200
5.0L (GM)	1979-85	R2	2GE	18-7086	18-7200
5.0L (GM)	1979-89	R4	4MV	18-7095	18-7201
5.0L (FORD)	1989	H2	2300	18-7081	18-7206
5.0,5.0 H.O. ③	1989-90	H4	4160	18-7237	N/A
5.0,5.0 H.O. ②	1989-90	H2	2300	18-7236	N/A
5.0,5.0 H.O. ③	1991	H4	4160	18-7245	N/A
5.0,5.0 H.O. ②	1991	H4	4175	18-7244	N/A
5.0,5.0 H.O. ①	1992	H4	4150	18-7242	N/A
5.7L	1979-89	R4	4MV	18-7095	18-7201
5.7	1990-92	H4	4175	18-7239	N/A
5.7 LE ⑨	1991-92	H4	4175	18-7243	N/A
5.7 LE ④	1990	H4	4175	18-7239	N/A
5.8L	1989	H4	4160	18-7017	—
7.5L	1987-88	H4	4160	18-7017	—
305 C.I./B	1977-79	R2	2GE	18-7086	18-7200
305 C.I./B	1977-78	R4	4MV	18-7018	18-7201
305 C.I./B	1979-83	R4	4MV	18-7095	18-7201
350 C.I./B	1977-78	R4	4MV	18-7018	18-7201

② For 2V Carburetors      ⑥ For 1990 PWC Suffix Only      ① For Engine Model 744DPEAMH, 744DPPAMH  
 ③ For 4V Carburetors      ⑨ For Engine Model 574APERGD      ② For Engine Model 744CPEAMH, 824BPEAM  
 ④ For Engine Model 574APEPWS

**CARBURETOR KIT/FLOAT APPLICATION (Cont.)**

Model	Years	Mfg. Code	Carb. Model	Carb. Kit	Float
350 C.I./B	1979-83	R4	4MV	18-7095	18-7201
350 ④ ③	1988-89	R4	4MV	18-7095	18-7201
350 ②	1988	R2	2GE	18-7086	18-7200
351 CID/5.8L H.O.	—	H4	4010, R50483A, R84046A (F1JL-9510-EA)	18-7727	—
351 CID/5.8L	—	H4	4160, R9393A, R9394A, R50399A, R50399-1A	18-7729	—
351 CID/5.8L	—	H4	4160C, R80434A	18-7730	—
454 C.I./B	1977-78	R4	4MV	18-7072	18-7201
454,454 H.O. ①	1991-92	H4	4150	18-7242	N/A
454,454 H.O. ②	1990-92	H4	4150	18-7241	N/A
460 C.I.	1987-88	H4	4160	18-7017	—
460	1989-90	H4	4160	18-7235	N/A

- ② For 2V Carburetors
- ③ For 4V Carburetors
- ④ For Engine Model 574APEPWS
- ⑥ For 1990 PWC Suffix Only
- ⑨ For Engine Model 574APERGD
- ① For Engine Model 744DPEAMH, 744DPPAMH
- ② For Engine Model 744CPEAMH, 824BPEAM

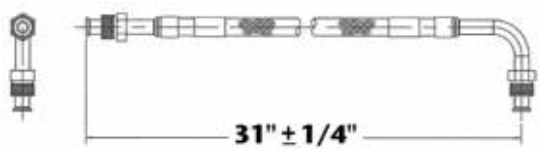



**18-8114 FUEL LINE HOSE**  
For fuel pump to carburetor connection. Replaces copper or steel tubing 3/8" X 31" PTFE composite hose with 5/8"-18 male inverted flare straight one end, 5/8"-18 90° one end. SAE J1527 type A1

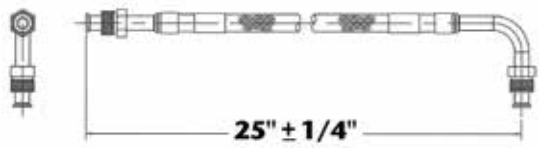



**18-8115 FUEL LINE HOSE**  
For fuel pump to carburetor connection. Replaces copper or steel tubing 3/8" X 25" PTFE composite hose with 5/8"-18 male inverted flare straight one end, 5/8"-18 90° one end. SAE J1527 type A1





**18-7229 FLAME ARRESTOR**  
Replaces: 986865, 981566

**ALL SIERRA FUEL PUMPS INCLUDE MOUNTING GASKET**



**18-7256 FUEL PUMP**  
Flange I.D. # 6790  
For: GM (4 & 6 cyl.)153, 230, 250, 292



**18-7258 FUEL PUMP**  
Replaces: 380986  
Flange I.D. # 40001, M3643  
For: GM (V-6) 225, PB-V215



**18-7265 FUEL PUMP**  
Flange I.D. # 41412, M73018  
For: GM (V-8) 305, 350, 400



**18-7267 FUEL PUMP**  
Replaces: 982063  
Flange I.D. # 40778, M73016  
For Ford (V-8) 302



**18-7268 FUEL PUMP**  
Replaces: 981650  
Flange I.D. #41415  
For: GM (V-8) 305, 307, 350, 400  
Dual diaphragm sight glass required.

APPLICATION BEGINS ON NEXT PAGE



**18-7278**  
**FUEL PUMP**  
 Replaces: 985602, 985603, 982240  
**Flange I.D. #M60032**  
 For: GM (4 & 6 cyl.) 153, 181, 250, 224, 225



**18-7289**  
**FUEL PUMP**  
 Replaces: 982997  
**Flange I.D. # 60201**  
 For: GM (V-6) 262/4.36



**18-7326**  
**ELECTRIC FUEL PUMP**  
 Replaces: 3858261, 3857986,  
 3850809, 3854620



**18-7330**  
**ELECTRIC FUEL PUMP**  
 Replaces: 3857650, 3855958, 3854280,  
 987620, 988037



**18-7331**  
**ELECTRIC FUEL PUMP**  
 Replaces: 3850810

**FUEL PUMP APPLICATION**

Model	Years	Pump #	Model	Years	Pump #
2.5	1982-85	18-7278	175	1975-77	—
5	1982-88	18-7268	185	1978-80	18-7268
5.7	1982-92	18-7268	190	1974-77	—
100	1972-73	18-7278	200	1979-81	18-7268
110	1964	18-7278	225	1978	18-7268
120	1965-80	18-7278	230	1979-81	18-7268
140	1973-81	18-7278	235	1975-77	—
140 Jet Drive	1973	18-7278	240	1978	—
150	1964	18-7258	245 Jet Drive	1973	18-7278
150 Model HU-13EM	1965	18-7258	250	1979	—
150 Except HU-13EM	1965	18-7258	260	1979-81	18-7268
165	1972-76	18-7278	305 CID IB	1979-82	18-7268
170	1974	—	350 CID IB	1979-82	18-7268
			350	1988-91	18-7268

**ELECTRIC FUEL PUMP APPLICATION**

Year	Engine	Application	OE #	#'s Superseded from	Part #
1992-94	262/4.3L	Low Pressure	3858261	3850809,3850810,3857985	18-7326
1997-98	350/5.7L, 454/7.4L, & 502/8.2L	Engines w/MPI - High Pressure	3857650		18-7330
1996	454/7.4L & 502/8.2L	Engines w/MPI - High Pressure	3857650		18-7330
1993-94	4.3L thru 5.8L	Low pressure electric fuel pump	3858261	3850809	18-7326
1992-1994	454/7.4L & 502/8.2L	GM Mark V Eng. - Low Pressure	3858714	3850810, 3857985	18-7331

- UNIVERSAL DESIGN -

**FUEL WATER SEPARATOR BRACKETS**



Bracket Type	Part #	Bracket Type	Part #
1/4" Stainless Steel	18-7777	1/4" Aluminum	18-7853-1
3/8" Stainless Steel	18-7776	3/8" Aluminum	18-7775



# FUEL WATER SEPARATOR KITS



## 21 MICRON FILTER KITS - FOR CARBURETED ENGINES

Kit Type	Part #	Micron Rating	Contents
1/4" Aluminum (Short Filter)	18-7848-1	21	1 - 18-7844 filter & 1 18-7853-1 bracket 2 - 18-4256 1/4" pipe plugs
1/4" Aluminum Bonus Pack <b>Contains spare filter</b>	18-7848-2	21	2 - 18-7844 filter & 1 18-7853-1 bracket 2 - 18-4256 1/4" pipe plugs
1/4" Aluminum (Tall Filter)	18-7852-1	21	1 - 18-7845 filter & 1 18-7853-1 bracket 2 - 18-4256 1/4" pipe plugs
1/4" Aluminum Bonus Pack <b>Contains spare filter</b>	18-7852-2	21	2 - 18-7845 filter & 1 18-7853-1 bracket 2 - 18-4256 1/4" pipe plugs
3/8" Aluminum (Tall Filter)	18-7775-1	21	1 - 18-7845 filter & 1 18-7775 bracket 2 - 18-4264 3/8" pipe plugs
1/4" Stainless Steel (Tall Filter)	18-7777-1	21	1 - 18-7845 filter & 1 18-7777 bracket 2 - 18-4256 1/4" pipe plugs
3/8" Stainless Steel (Tall Filter)	18-7776-1	21	1 - 18-7845 filter & 1 18-7776 bracket 2 - 18-4264 3/8" pipe plugs



## 10 MICRON FILTER KITS FOR FUEL INJECTED ENGINES

Kit Type	Part #	Micron Rating	Contents
1/4" Aluminum (Short Filter)	18-7983-1	10	1 - 18-7944 filter & 1 18-7853-1 bracket 2 - 18-4256 1/4" pipe plugs
1/4" Aluminum Bonus Pack <b>Contains spare filter</b>	18-7983-2	10	2 - 18-7944 filter & 1 18-7853-1 bracket 2 - 18-4256 1/4" pipe plugs
1/4" Aluminum (Tall Filter)	18-7982-1	10	1 - 18-7945 filter & 1 18-7853-1 bracket 2 - 18-4256 1/4" pipe plugs
1/4" Aluminum Bonus Pack <b>Contains spare filter</b>	18-7982-2	10	2 - 18-7945 filter & 1 18-7853-1 bracket 2 - 18-4256 1/4" pipe plugs
1/4" Aluminum (High Capacity Filter)	18-7966-1	10	1 - 18-7866 filter & 1 18-7853-1 bracket 2 - 18-4256 1/4" pipe plugs
3/8" Aluminum (Tall Filter)	18-7986-1	10	1 - 18-7945 filter & 1 18-7775 bracket 2 - 18-4264 3/8" pipe plugs
1/4" Stainless Steel (Tall Filter)	18-7984-1	10	1 - 18-7945 filter & 1 18-7777 bracket 2 - 18-4256 1/4" pipe plugs
3/8" Stainless Steel (Tall Filter)	18-7985-1	10	1 - 18-7945 filter & 1 18-7776 bracket 2 - 18-4264 3/8" pipe plugs



## 10 MICRON FILTER KITS WITH DRAIN BOWLS

Sierra AquaVue™ and metal bowl separator filters allow water to be drained from the filter to extend service life. Use the AquaVue™ bowl for outboard, above deck installations. USCG regulations require the use of the flame resistant metal bowl below deck.

Kit Type	Part #	Micron Rating	Contents
1/4" Aluminum w/ metal drain bowl	18-7951	10	1 - 18-7919 filter & 1 18-7853-1 bracket 1 - 18-7924 metal bowl 2 - 18-4256 1/4" pipe plugs
1/4" Stainless Steel w/ metal drain bowl	18-7938	10	1 - 18-7919 filter & 1 18-7777 bracket 1 - 18-7924 metal bowl 2 - 18-4256 1/4" pipe plugs

**COMPACT BRACKET AND SEPARATOR KIT - FOR SMALL OUTBOARDS AND FRESH WATER APPLICATIONS**

18-7774  
COMPACT ALUMINUM BRACKET



18-7965-1  
10 MICRON COMPACT SEPARATOR KIT  
Contains:  
1 - 18-7774 bracket  
1 - 18-7865 filter



**REPLACEMENT FILTERS**



**UNIVERSAL DESIGN**

10 MICRON REPLACEMENT FILTERS			21 MICRON REPLACEMENT FILTERS		
Part #	Description		Part #	Description	
18-7944	Short - 3.875"		18-7844	Short - 3.875"	
18-7945	Long - 4.35"			Long - 4.35"	
18-7866	High Capacity - 6"		18-7845	Short - 3.875"	
18-7865	Compact 10 Micron			Long - 4.35"	

**REPLACEMENT FILTERS FOR OMC**

10 MICRON REPLACEMENT FILTERS			21 MICRON REPLACEMENT FILTERS		
Part #	Description	Replaces	Part #	Description	Replaces
18-7946	OMC thread	OMC 502905	18-7846	OMC thread	OMC 502905
18-7989	Cobra EFI	OMC 502906	18-7789	Cobra EFI	OMC 502906



**10 MICRON REPLACEMENT FILTERS AND KITS WITH DRAIN BOWLS**

REPLACEMENT FILTERS			FILTER & BOWL KITS		
Part #	Description	Replaces	Part #	Description	
18-7919	Spin on replacement	Racor S3213	18-7929	Filter & Metal Bowl Contains: 18-7919 filter, 18-7924 bowl	
18-7920	Spin on replacement	OMC 771839 Racor S3214		18-7941	Filter & AquaVue™ Bowl OMC style Contains: 18-7920 filter, 18-7922 bowl
18-7947	Spin on replacement Fits - 120RRAC01	Racor S3240	18-7943		Filter & Metal Bowl OMC style Contains: 18-7920 filter, 18-7924 bowl
18-7948	Spin on replacement Fits - 320RRAC01	Racor S3227			
18-7949	Spin on replacement Fits - 660RRAC02	Racor S3232			
REPLACEMENT BOWLS			REPLACEMENT ELEMENTS		
Part #	Description		Part #	Description	Replaces
18-7924	Metal Collection Bowl		18-7930	1977-83 Fuel system with add on filter kit	OMC 173326



18-7792  
FUEL FILTER  
Replaces: 910641, 3855104  
Fits: OMC 3.0L (1996-98), 3.8L/170 (1981)



18-7854  
FUEL FILTER  
Replaces: 984491, 311684  
Rochester 17078904



18-7855  
FUEL FILTER  
Replaces: 983870, 910139  
Rochester 17068453



**18-7717  
FILTER ELEMENT**  
For: Rochester 2 bbl & 4 bbl Carburetors



**18-7859  
FUEL FILTER**  
Replaces: 908034  
For: Most GM Inline 4 & 6 cycle:  
Ford and GM V-8's up to 400 HP



**18-7860  
FUEL FILTER**  
Replaces:  
381690, 312456  
**with AC Fuel Pumps**  
For: Inline 4 & 6 cycle engines



**18-7861  
REPLACEMENT  
CANISTER AND FILTER**  
Replaces: 981911



**18-7862  
FUEL FILTER ELEMENT**  
For Fuel Filter  
(Includes Gasket)  
Replaces: 982230



**18-7964  
TRANSMISSION FILTER KIT**



**18-8072  
FUEL ELBOW**  
3/8" Hose Barb with  
3/8" NPT Thread  
Replaces: 174177  
90

Display Package



**HOSE BARB  
NPT Thread**  
**18-8074** 3/8" with 1/4"  
**18-8055** 5/16" with 1/4"  
Replaces: 173312 Replaces: 173311

Display Package

PKG OF 10



**SNAPPER CLAMPS**

Part #	Clamp O.E. #	Clamp Range	Size
<b>18-8020</b> ①	322652	.538 - .608	8
<b>18-8021</b> ①	911616	.597 - .665	10
<b>18-8034</b> ①	329654	.670 - .780	12
<b>18-8200</b> ①	322653	.360 - .406	2
<b>18-8201</b> ①	124249	.410 - .468	4
<b>18-8202</b> ①	322654	.475 - .536	6
<b>18-8203</b> ①	329653	.750 - .875	14
<b>18-8204</b> ①	324825	.875 - .975	19

**ALL SIERRA WATER PUMPS ARE BI-DIRECTIONAL**



**18-3574  
CIRCULATING WATER PUMP**  
Big block GM engines with composite timing covers "Late Model" includes 482 and 502 CID  
Replaces: 3855991



**18-3575  
CIRCULATING WATER PUMP**  
Replaces: 984360, 986779, 380640, 3854017



**18-3577  
CIRCULATING WATER PUMP**  
Replaces: GM 6269358, OMC 987447, 983296, 986074, 3854118



**18-3578  
CIRCULATING WATER PUMP**  
Replaces: 984876



**18-3583  
CIRCULATING WATER PUMP**  
Replaces: 985429, 980477, 382218, 3853850



**18-3584  
CIRCULATING WATER PUMP**  
Replaces: 982517, 3853796, 982515

① This product is priced per piece. To order priced per package, please add -9 to the part number.

**WATER CIRCULATING PUMP APPLICATION**

Model	Year	Part #	Model	Year	Part #	Model	Year	Part #
2.3	1987-90	18-3578	165	1972-76	18-3575	245	1972-75	18-3583
2.5	1982-86	18-3575	175	1977	18-3584	245		
3	1982-92	18-3575	185	1967-80	18-3583	Jet Drive	1972-75	18-3583
3.8	1981-86	18-3583	190	1977	18-3584	250		
4.3	1985-92	18-3583	200	1979-81	18-3583	Inboard	1970-74	18-3583
5	1982-88	18-3583	210	1968-70	18-3583	250	1979	18-3575
5	1989-92	18-3575	210			260		
5.7	1982-92	18-3583	Inboard	1970-72	18-3583	Inboard	1975-76	18-3583
5.8	1989-92	18-3575	215	1971	18-3583	260	1979-81	18-3583
100	1972	18-3575	225	1972-78	18-3583	262	1989	18-3583
100	1973	18-3583	225			290		
120	1965-69	18-3575	Inboard	1973-74	18-3583	Jet Drive	1974-75	18-3583
120	1972	18-3575	230			305 CID IB	1977-82	18-3583
120	1973-74	18-3583	Inboard	1975-76	18-3583	350 CID IB	1977-82	18-3583
120	1975-81	18-3575	230	1979-81	18-3583	350	1988-92	18-3583
140			235	1971	18-3583	351	1992	18-3584
Jet Drive	1973	18-3575	235	1977	18-3584	454 CID IB	1977-80	18-3577
140	1973-81	18-3575	240	1978	18-3584	454 CID IB	1982	18-3583



**18-3005  
IMPELLER**  
Replaces: 377992



**18-3058  
IMPELLER**  
Replaces: 983895



**18-3086  
IMPELLER**  
Replaces: 379475, 777130

**IMPELLER APPLICATION**

Model	Years	Impeller	Model	Years	Impeller
2.3	1987-90	18-3058 ③	175	1975-77	18-3086
2.5	1986	18-3058	185	1967-68, 1978-84	18-3086
3	1986-92	18-3058 ③	190	1974-77	18-3086
4.3	1986-92	18-3058	200	1966-68, 1979-84	18-3086
5	1986-92	18-3058	210	1968-72	18-3086
5.7	1986-92	18-3058 ④	215	1971	18-3086
5.8	1989-92	18-3058	225	1972-76, 1978	18-3086
7.5	1987	18-3058	230	1975-76, 1979-81	18-3086
80	1968-69	18-3005	235	1971, 1975-77	18-3086
88	1964	18-3005	240	1978	18-3086
90	1965-68, 1970-71	18-3005	245	1972-75	18-3086
100	1972-73	18-3086	250	1970-74, 1979	18-3086
110	1964	18-3005 ①	260	1975-76, 1979-84	18-3086
110	1964	18-3086 ②	262	1989	18-3058
120	1965-67	18-3005 ①	305	1977-78	18-3086
120	1965-67	18-3086 ②	350	1977-78	18-3086
120	1968-84	18-3086	350	1988-91	18-3058
140	1973-84	18-3086	370	1988	18-3058
150	1964-66	18-3086	454	1977	18-3086
155	1967-72	18-3086	454	1990-91	18-3058
165	1972-76	18-3086	460	1988-90	18-3058
170	1974	18-3086			

- ① Standard pump
- ② Heavy duty pump

- ③ Except models originally equipped with short impeller or retrofitted with short impeller kit
- ④ Except 1992 5.7 L.E. models



**18-3108  
IMPELLER KEY**  
Replaces: 308928  
Fits: Stern Drive models (1968-85)  
For: Stringer Drive Impellers 18-3005 & 18-3086



**18-3111  
WATER PUMP  
SHAFT SEAL**  
Replaces: 907774  
I/O 1972-86  
EXCEPT COBRA



**18-4833  
WATER PASSAGE  
HOUSING  
(LOWER UNIT)**  
Replaces: 915720  
Fits: OMC Cobra (1986-93) without cone clutch



**18-4837  
WATER PASSAGE COVER**  
Replaces: 911734  
Fits: OMC Cobra (1986-93) without cone clutch



**18-3119  
WATER PUMP HOUSING**  
Replaces: 983298



**18-3206  
WATER PUMP HOUSING**  
Replaces: 984744  
For: OMC Cobra



**18-3145  
PUMP LINER**  
Replaces: 911844



**18-3121  
IMPELLER PLATE**  
Replaces: 911703  
COBRA



**18-3141  
IMPELLER PLATE**  
Replaces: 313176  
110-260 HP I/O 1968-86  
EXCEPT COBRA



**18-3502  
WATER PUMP VENT HOSE**  
Replaces: 912614  
Fits: OMC Cobra (1986-93) without cone clutch

① **18-3212-1D** Display Package



**18-3212-1  
IMPELLER  
REPAIR KIT**  
Replaces: 984461

— CONTAINS —

Part #	Description	O.E.M. #	Qty.
18-2541	O-Ring	911704	1
18-2916	Water Pump Housing Gasket	911702	1
18-3058	Impeller	983895	1
18-3121	Impeller Plate	911703	1
18-3145	Pump Liner	911844	1



**18-3286  
IMPELLER  
REPAIR KIT**  
1964-86  
EXCEPT COBRA

— CONTAINS —

Part #	Description	O.E.M. #	Qty.
18-7135	O-Ring	310584	1
18-3141	Plate	313176	1
18-7129	O-Ring	314491	1
18-3111	Rubber Seal	907774	1
18-3086	Impeller	379475	1
18-7158	O-Ring	310585, 310967	1



**18-3386  
WATER PUMP KIT**  
Replaces: 983218  
1964-86  
EXCEPT COBRA

— CONTAINS —

Part #	Description	O.E.M. #	Qty.
18-7135	O-Ring	310584	1
18-3141	Plate	313176	1
18-7129	O-Ring	314491	1
18-3086	Impeller	379475	1
18-3111	Rubber Seal	907774	1
18-3119	Impeller Housing	983298	1
18-7158	O-Ring	310585, 310967	1



**18-3348  
COMPLETE WATER PUMP KIT**  
Replaces: 984461  
For: All OMC Cobra Drives-2.3 (1987-90), 2.5 (1986), 3.0(1986-93), 4.3(1986-93), 4.6(1989), 5.0(1986-93), 5.7(1986-93), 5.8 (1989-93), 7.5(1987-89)



**18-3349  
WATER PUMP HOUSING KIT**  
For: All OMC Cobra Drives-2.3 (1987-90), 2.5 (1986), 3.0(1986-93), 4.3(1986-93), 4.6(1989), 5.0(1986-93), 5.7(1986-93), 5.8 (1989-93), 7.5(1987-89)



**18-5897  
SENDER**  
Replaces: 980613  
3/8" — 18 NPT  
For: Mercruiser Vazer



**18-5898  
SENDER**  
Replaces: 171960  
1/2" — 14 NPT



**18-5899  
OIL PRESSURE  
SENDER**  
Replaces: 982650



**18-3554  
THERMOSTAT**  
Replaces: 383307  
160°



**18-3558  
THERMOSTAT**  
Replaces: 982554, 3853799  
160°

① **18-3653D** Display Package



**18-3653  
THERMOSTAT KIT**

— CONTAINS —

Part #	O.E. #	Desc.
18-3554	383307	Thermostat
18-2858	314809	Manifold Gasket
18-2917	3701777 (GM)	Thermostat Gasket
18-2947	310913	Thermostat Gasket

APPLICATION FOR THERMOSTATS/KITS ON NEXT PAGE

① Items ending in "D" are Display Packaged - Regular number is Non-Display



① 18-3670D Display Package

**18-3670 THERMOSTAT KIT**  
Fits: 2.5L & 3.0L (1982-88)

— CONTAINS —

Part #	O.E.#	Desc.
18-3558	982554	Thermostat
18-2858	314809	Thermostat Housing Cover Gasket
18-0929	313416	Thermostat Gasket



① 18-3676D Display Package

**18-3676 THERMOSTAT KIT**  
140°

For: 7.4L (1994-98), 8.2L (1998)

— CONTAINS —

Part #	O.E.#	Desc.
18-7170	3852071	O-Ring
18-2917	3852111	Thermostat Gasket
—	3853983	Thermostat



① 18-3677D Display Package

**18-3677 THERMOSTAT KIT**  
160°

— CONTAINS —

Part #	O.E.#	Desc.
18-7170	3852071	O-Ring
18-2917	3852111	Thermostat Gasket
—	3856961	Thermostat

HP	Year	HP	Year
4.3L	1994-97	5.8L	1994-97
4.3 HO	1991-97	5.8 (EFI)	1993-97
5.0 L	1994-97		

**THERMOSTAT AND THERMOSTAT KIT APPLICATION**

Model	Years	Thermostat	Thermostat Kit	Model	Years	Thermostat	Thermostat Kit
90	1970	18-3554	18-3653	250	1970-73	18-3554	18-3653
100	1972-73	18-3554	18-3653	250	1979	18-3554	18-3653
120	1969-80	18-3554	18-3653 ①	260	1979-81	18-3554	18-3653
120	1980-81	18-3558	18-3670 ②	262	1989	18-3554	—
140	1973-80	18-3554	18-3653 ①	305	1977-82	18-3554	18-3653
140	1980-81	18-3558	18-3670 ②	350	1977-82	18-3554	18-3653
155	1969-72	18-3554	18-3653	350	1989	18-3554	—
165	1972-76	18-3554	18-3653	351	1992	18-3554	—
170	1974	18-3554	18-3653	454	1977-82	18-3554	18-3653
175	1975-77	18-3554	18-3653	460	1989	18-3554	—
185	1978-80	18-3554	18-3653	2.5L	1982-88	18-3558	18-3670
190	1974-77	18-3554	18-3653	3.0L	1982-88	18-3558	18-3670
200	1979-81	18-3554	18-3653	3.8L	1981-85	18-3554	18-3653
210	1969-72	18-3554	18-3653	4.3L	1985-86	18-3554	18-3653
215	1971	18-3554	18-3653	4.3L	1989-92	18-3554	—
225	1971	18-3554	18-3653	5.0L	1982-88	18-3554	18-3653
230	1979-81	18-3554	18-3653	5.0L	1989-92	18-3554	—
235	1971	18-3554	18-3653	5.7L	1982-88	18-3554	18-3653
235	1975-77	18-3554	18-3653	5.7L	1989	18-3554	—
240	1978	18-3554	18-3653	5.8L	1989-92	18-3554	—
245	1972-75	18-3554	18-3653	7.5L	1988	18-3554	18-3653

① 1980 Models with "C" suffix only      ② 1980 Models with "C1" suffix only

**SINGLE DIAMETER HOSE**



**18-70021 MOLDED HOSE**  
3/4" ID



**18-70704 MOLDED HOSE**  
1 1/4" ID

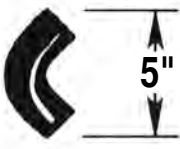

**18-70924 MOLDED HOSE**  
1 3/4" ID



**18-71218 MOLDED HOSE**  
1" ID



**18-71337 MOLDED HOSE**  
1 3/4" ID

**STRAIGHT HOSE**



**18-75100 MOLDED HOSE**  
Straight 48"  
1" ID



**18-75125 MOLDED HOSE**  
Straight 48"  
1 1/4" ID

① Items ending in "D" are Display Packaged - Regular number is Non-Display

## V-BELTS

- 1 High strength synthetic cords resist shockload failure. Their low stretch properties assure uniform performance over the life of the belt.
- 2 The compression section is a special rubber compound that assures smooth and even transfer of load forces to the cords.
- 3 Cogs are molded to precise engineering tolerances to improve flexibility and maintain cord support. Cog geometry provides a large area for air circulation to keep the belt cool and prevent damaging heat build up in the cushion section.
- 4 Rubber edges maintain positive, no-slip contact with pulley grooves for reliable energy transfer.



### BELT SIZE LISTING BY NUMBER

Part #	Effective Length (Inches)	Top Width (Inches)	Part #	Effective Length (Inches)	Top Width (Inches)	Part #	Effective Length (Inches)	Top Width (Inches)
18-15290	29	29/64	18-15405	40 1/2	29/64	18-15460	46	29/64
18-15300	30	29/64	18-15410	41	29/64	18-15470	47	29/64
18-15325	32 1/2	29/64	18-15415	41 1/2	29/64	18-15480	48	29/64
18-15345	34 1/2	29/64	18-15430	43	29/64	18-15495	49 1/2	29/64
18-15370	37	29/64	18-15435	43 1/2	29/64	18-15500	50	29/64
18-15380	38	29/64	18-15440	44	29/64	18-15520	52	29/64
18-15390	39	29/64	18-15450	45	29/64	18-15550	55	29/64
18-15400	40	29/64	18-15455	45 1/2	29/64			

### V-BELT INTERCHANGE

OMC #	Part #	Part #	OMC #
310953	18-15460	18-15380	910414
311046	18-15440	18-15400	311606
311606	18-15400	18-15415	910343
908929	18-15455	18-15435	912509
909818	18-15500	18-15440	311046
909971	18-15460	18-15450	914787
910343	18-15415	18-15455	908929
910414	18-15380	18-15460	310953
912418	18-15500	18-15460	909971
912509	18-15435	18-15500	909818
912714	18-15520	18-15500	912418
914787	18-15450	18-15520	912714

### HOSE INTERCHANGE

OMC #	Part #	Sierra #	Part #
312781	18-71337	18-71337	312781
910305	18-75100	18-75100	910305
912424	18-75100	18-75100	912424
912793	18-75125	18-75100	913488
913488	18-75100	18-75125	912793

### V-BELT APPLICATION

Model	Year	Water Alternator	Pump	Power Steering	Model	Year	Water Alternator	Pump	Power Steering
100	1972-73	18-15400	18-15400	—	262 KING COBRA	1989	—	*18-15380	18-15455
110	ALL	18-15440	18-15440	—	305	1977-84	18-15440	18-15440/ *18-15455 or *18-15500	—
120	1965-81	18-15400	18-15400	—	350	1977-84	18-15440	18-15440/ *18-15455 or *18-15500	—
140	1982-87	18-15400	18-15400	—	350 KING COBRA	1988-90	18-15455	18-15455	—
165	1972-76	18-15400	18-15400	—	350 KING COBRA	1988-90	18-15470	*18-15380	18-15455
170	1974	18-15400	18-15400	—	454	1977-82	18-15455	18-15455/ *18-15500	—
175	1975-77	18-15400	18-15400	—	454 KING COBRA	—	—	18-15470	18-15380
185 W/O PS	1978-84	18-15440	18-15440	—	460 KING COBRA	1988	18-15460	18-15460	18-15520
185 W/ PS	1978-84	18-15460	18-15460	18-15460	888	—	18-15435	18-15435	—
190	1974-77	18-15400	18-15400	—	2.3L	1987-90	18-15435	18-15435	18-15435
200 W/O PS	1979-81	18-15440	18-15440	—	2.5L W/O PS	1982-87	18-15415	18-15415	—
200 W/ PS	1979-81	18-15460	18-15460	18-15460	2.5L W/ PS	1982-87	18-15400	18-15400	18-15460
210	1970-71	18-15440	18-15440	—	3.8L W/O PS	1982-90	18-15400	18-15400	—
215	1971	18-15440	18-15440	—	3.8L W/ PS	1982-90	—	*18-15380	18-15455
225	1972-84	18-15440	18-15440	—	5.0L W/O PS	1982-90	18-15455	18-15455	—
230,260	1975	18-15440	18-15440/ *18-15455	—	5.0L W/ PS	1982-90	—	*18-15380	18-15455
230,260	1979-81	18-15440	18-15440	—	7.5L	1987	18-15460	18-15460	18-15520
230,260	1979-81	18-15460	18-15460	18-15460					
235	1971	18-15440	18-15440	—					
235	1975-77	18-15400	18-15400	—					
240	1978-84	18-15400	18-15400	—					
250	1979	18-15400	18-15400	—					
262 KING COBRA	1989	18-15400	18-15400	—					

\* W/ SEA WATER PUMP

# Fits GM 181 CID 3.0L, 4 Cylinder

## Fits Most 141 Models

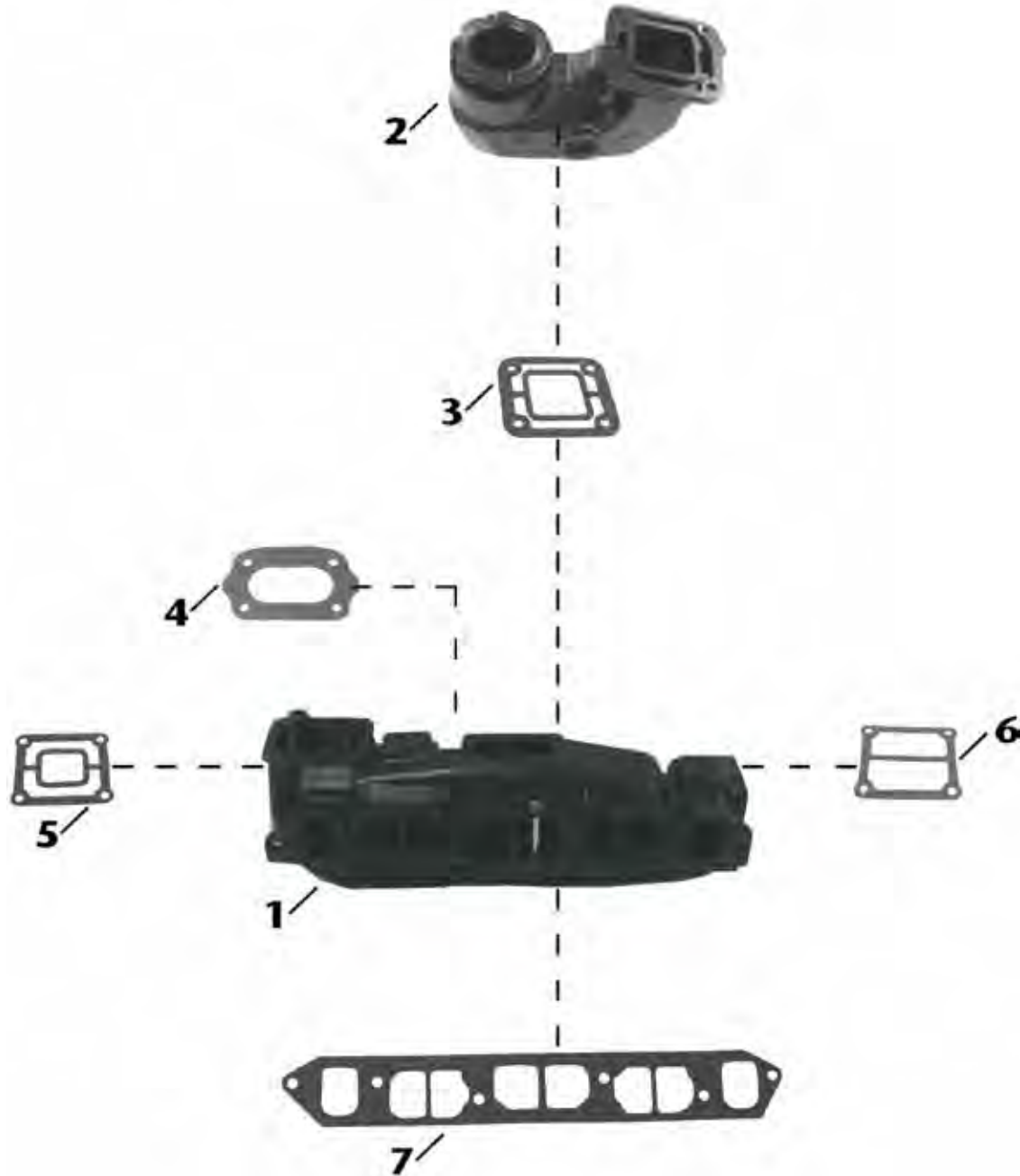

Item No	Description	OE No.	Application
1	18-1901 MANIFOLD	982490, 980083, 984054	GM 181 cu.in. 3.0L , 4 Cylinder. Fits most 140 models.
2	18-1922 MANIFOLD ELBOW	987784	Use with Manifold: 18-1901; Elbow Gasket: 18-2875
3	18-2875 ELBOW GASKET	385049	Use with Elbow: 18-2875
4	18-0937 CARBURETOR GASKET	315055	Use with Manifold: 18-1901
5	18-2861 END PLATE GASKET	311121	Use with Manifold: 18-1901
6	18-0114 END PLATE GASKET	907761	Use with Manifold: 18-1901
7	18-1204 MANIFOLD GASKET	912164	Use with Manifold: 18-1901



## Fits GM Small Block V8 305-350 cu. in. 1979-1989

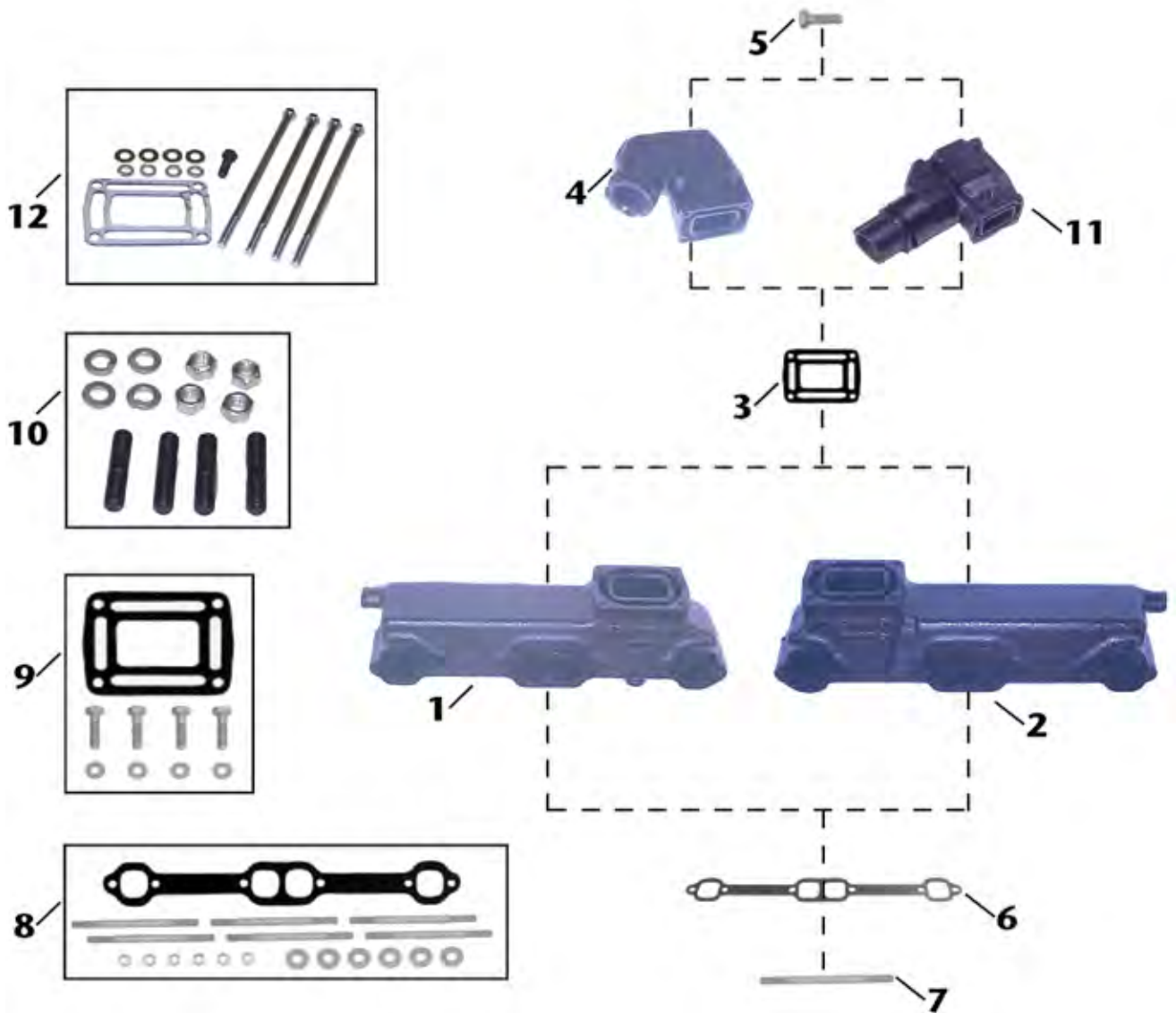

Item No	Description	OE No.	Application	
1	18-1902	MANIFOLD (STARBOARD)	912441	GM Small Block (V8) 305-350 cu.in. (1979-1989)(Starboard) Use with Manifold Gasket: 18-2949. Mounting Kit: 18-8502
2	18-1903	MANIFOLD (PORT)	912442	GM Small Block (V8) 305-350 cu.in. (1979-1989)(Port). Use with Manifold Gasket: 18-2949. Mounting Kit: 18-8502
3	—	ELBOW GASKET	909786	Use with Elbow: 18-1921; Mounting Kit: 18-8534.
4	18-1921	MANIFOLD ELBOW	909863	Use with Manifold: 18-1902, 18-1903. Mounting Kit: 18-8534.
5	NSS	MOUNTING BOLT	N/A	Included in 18-8534 mounting kit.
6	18-2949	MANIFOLD GASKET	96306	Use with Manifold: 18-1902, 18-1903. Included in 18-8502 mounting kit.
7	NSS	MOUNTING STUD	N/A	Included in 18-8502 mounting kit.
8	18-8502	MOUNTING KIT	N/A	Use with Manifold: 18-1902, 18-1903. Includes 18-2949 manifold gasket.
9	18-8534	MOUNTING KIT	N/A	Use with Elbow: 18-1921.
10	18-8553	HARDWARE KIT	N/A	Hardware only for Elbow 18-1921.
11	18-1909-1	MANIFOLD ELBOW	N/A	Use with Elbow Gasket: 18-0943-1
12	18-8507	MOUNTING KIT	N/A	Use with Manifold Elbow: 18-1909-1

## Fits GM Small Block V8 305-350 cu. in.

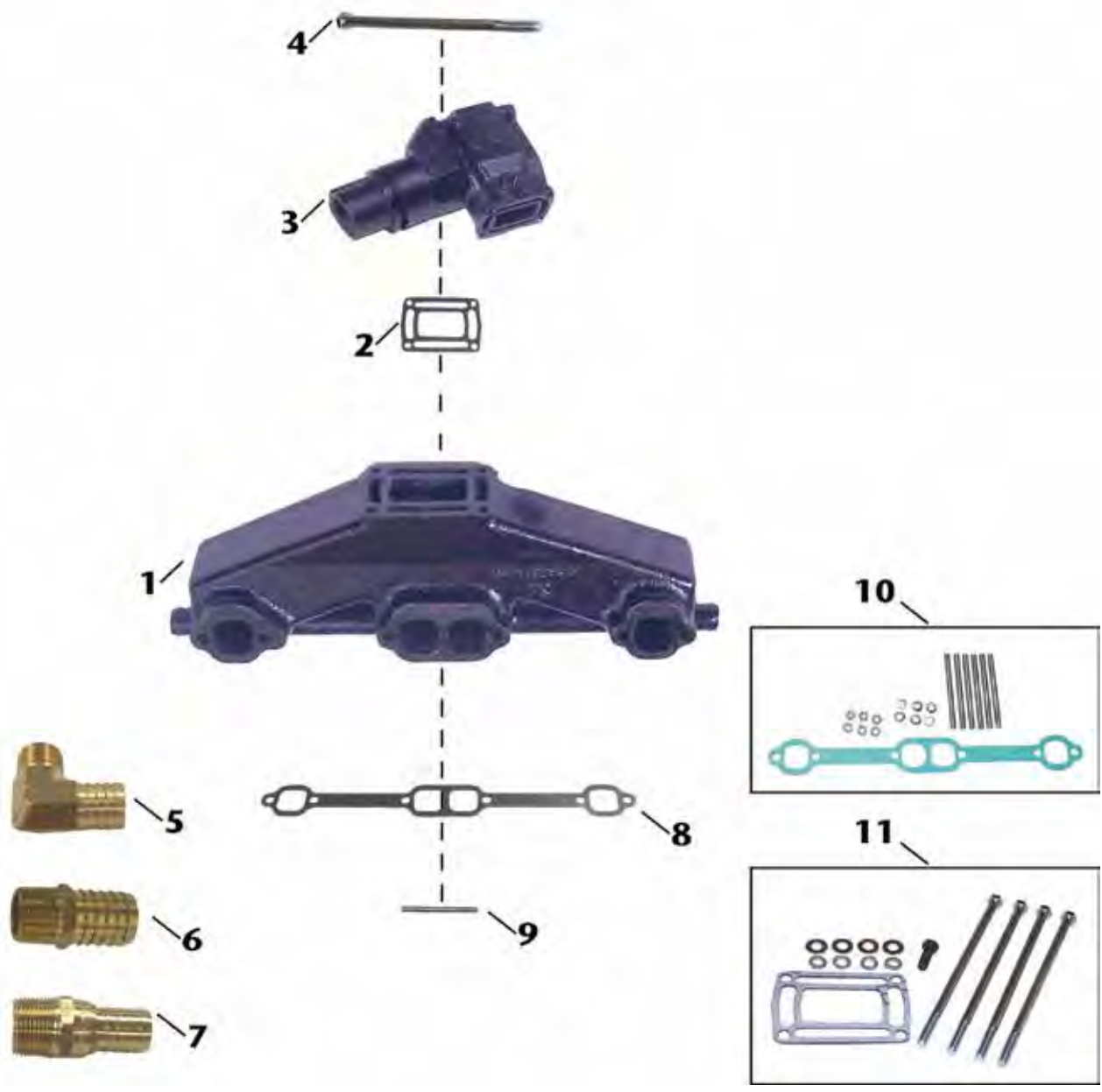

Item No	Description	OE No.	Application
1	18-1986-1 MANIFOLD	3857723	GM Small Block (V8) 305-350 cu.in. Use with Manifold Gasket: 18-2949; Mounting Kit: 18-8502.
2	— ELBOW GASKET	909786	Use with Elbow: 18-1909-1. Included in 18-8507 mounting kit.
3	18-1909-1 MANIFOLD ELBOW	913784, 3855270, 3850459, 3857944	Use with Manifold: 18-1986-1; Mounting Kit: 18-8507.
4	NSS MOUNTING BOLT	N/A	Included in 18-8507 mounting kit.
5	18-8216 HOSE FITTING	N/A	3/4" - 14NPT X 1" Hose (Corrosion Resistant Brass Fitting)
6	18-4461 HOSE FITTING	N/A	3/4" - 14NPT X 1" Hose (Corrosion Resistant Brass Fitting)
7	18-8215 HOSE FITTING	N/A	3/4" - 14NPT X 3/4" Hose (Corrosion Resistant Brass Fitting)
8	18-2949 MANIFOLD GASKET	96306	Use with Manifold: 18-1986-1. Included in 18-8502
9	NSS MOUNTING STUD	N/A	Included in 18-8502 mounting kit.
10	18-8502 MOUNTING KIT	N/A	Use with Manifold 18-1986-1. Includes 18-2949 manifold gasket.
11	18-8507 MOUNTING KIT	N/A	Use with Elbow: 18-1909-1. Includes 18-0943-1 elbow gasket.

# SIERRA MANIFOLDS ARE PAINTED, PACKAGED AND LEAK TESTED



**18-1901  
MANIFOLD**  
Replaces: 984054  
Fits 181 CID model 140  
and 3.0L (1973 - 1989)  
Use with:  
Exhaust Elbow Gasket: 18-1204  
**\*For Exploded View - See PAGE 772**



**18-1898  
MANIFOLD**  
Port & Starboard  
Replaces: Barr CHVA-1-84, Marine Power 0991-110  
Fits 454 cu.in. GM big block V8 engines  
Use with:  
Exhaust Manifold Gasket: 18-0418  
**\*For Exploded View - See Pages 556-557**



**18-1997-1  
EXHAUST MANIFOLD**  
Port & Starboard  
Replaces Barr CHV-1-83 Universal Center Riser Manifold  
FITS: GM 283, 305, 307 and 350 CID engines  
Use with:  
Exhaust Manifold Gasket Set: 18-0604  
**\*For Exploded View - See Pages 558-559**



**18-1998-1  
EXHAUST MANIFOLD**  
Port & Starboard  
Replaces: Barr FM-1-83  
Universal Center Riser Manifold  
FITS: Ford 302 and 351 CID engines  
Use with:  
Exhaust Manifold Gasket Set: 18-0603  
**\*For Exploded View - See Pages 560-561**



**18-1986-1  
MANIFOLD**  
Port & Starboard  
Replaces: 3852374, 3857723  
For: GM Small Block V8 305-350 ci  
Use with:  
Exhaust Manifold Gasket: 18-2949  
Mounting Kit: 18-8502



**18-1902  
MANIFOLD**  
Replaces: 912441  
V-8 - STARBOARD SIDE  
Fits most GM V-8 small blocks with end riser  
Use with:  
Mounting Kit: 18-8502



**18-1903  
MANIFOLD**  
Replaces: 912442 V-8 - PORT SIDE  
Fits most GM V-8 small blocks with end riser  
Use with:  
Mounting Kit: 18-8502



**18-1904  
MANIFOLD**  
Port & Starboard  
Replaces: 980959 V-8 - EITHER SIDE  
Fits most Ford V-8 302 & 351W with end riser  
Use with:  
Exhaust Manifold Gasket: 18-0183 or 18-2896  
(See Application Chart)



**18-1876  
RISER**

Replaces: 980617  
Use with:  
Manifold: 18-1904  
Riser Gasket: 18-2850  
Fits: 170 (1974), 175 (1975-76),  
190 (1974-76), 235 (1975-76)



**18-1991  
30° EXHAUST ELBOW ADAPTER**

For use with 3" I.D.  
Exhaust Hose  
Use with:  
Manifold Riser: 18-1999



**18-1992-1  
80° EXHAUST ELBOW**

For 3" I.D. Exhaust Hose  
(As used in 18-1987 Exhaust  
Manifold Conversion Kit)



**18-1921  
ELBOW MANIFOLD**

Replaces: 909863  
V-8  
Fits most GM V-8 small blocks  
Use with:  
Manifold: 18-1902, 18-1903  
Elbow Gasket: 18-0943-1  
Mounting Kit: 18-8534



**18-1922  
ELBOW MANIFOLD**

Replaces: 987784  
4 CYL.  
Fits most 140 HP 3.0L (181 CID)  
Use with:  
Manifold: 18-1901  
Elbow Gasket: 18-2875



**18-1909-1  
RISER**

Replaces:  
OMC 913784, 3855270, 3850456, 3857944,  
VOLVO 3855270-9, 3857944-7, 3863061  
OMC Riser, 4" outlet 7°: Fits many GM & Ford center rise  
manifolds.  
Use with:  
Manifold: 18-1986-1  
Riser Gasket: 18-0943-1  
Mounting Kit: 18-8507



**18-1939  
RISER**

Replaces: Barr 20-0100, Marine Power 0992-593 Barr, Indmar  
and Marine Power Ford Small Block V8 302-351cu.in., GM Small  
Block V8 305-350cu.in., GM Big Block V8 454cu.in.  
Use with:  
Manifold: 18-1997-1, 18-1998-1  
Riser Gasket: 18-2854 open or 18-0476 blocked  
Mounting Kit: 18-4364 open or 18-8535 blocked



**18-1907  
RISER**

Replaces: Barr 20-0102, Indmar 53-2009,  
53-2018, Barr and Indmar Ford Small Block  
V8 302-351cu.in.  
Use with:  
Manifold: 18-1997-1, 18-1998-1  
Riser Gasket: 18-2854 open or  
18-0476 blocked  
Mounting Kit: 18-4364 open or 18-8535  
blocked



**18-1999  
EXHAUST  
MANIFOLD  
RISER**

Replaces: Barr 20-0082  
Use with:  
Manifold: 18-1997-1 or 18-1998-1  
Riser Gasket: 18-2854 open  
Comes with 18-4364 open  
If blocked mounting kit is required use 18-8535  
Replaces: Barr 20-0082-P



**18-4009  
MANIFOLD END PLATE**

Replaces: 910384



**PIPE PLUGS**

Part #	Thread Size
18-4256	1/4"
18-4257	1/4"
18-4258	3/4"
18-4263	1/8" - 27 NPT
18-4264	3/8" - 18 NPT

56507 Pipe Sealant with Teflon®  
is recommended for use on plug threads.



**18-4461  
HOSE BARB**

3/4" - 14 NPT X 1" Hose  
Corrosion Resistant Brass Fitting



**18-8216  
HOSE BARB**

Fits: OMC - In-Line 6 Cylinders

**① 18-4218D**

Display Package





**18-4218  
BRASS DRAIN COCK**

Replaces: 379957  
1/4"  
**18-3223-9** Bulk Pack of 12



① Items ending in "D" are Display Packaged - Regular number is Non-Display

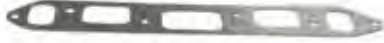

 <p><b>18-4363 MOUNTING PACKAGE</b> Replaces: Barr FM-1-83-P Use with: Manifold: 18-1998-1</p>	 <p><b>18-4364 (Open) MOUNTING PACKAGE</b> Replaces: Barr 20-0082-P Use with: Riser: 18-1999, 18-1939, 18-1907</p>	 <p><b>18-8502 MOUNTING KIT</b> OMC GM Small Block V8 305-350cu.in. (1979-89) OMC/Volvo GM Small Block 305-350cu.in. Used with: Manifolds: 18-1931-1, 18-1902 &amp; 18-1903</p>
 <p><b>18-8507 MOUNTING KIT</b> OMC/Volvo GM Small Block V8 305-350cu.in. Used with: Riser: 18-1909-1</p>	 <p><b>18-8534 MOUNTING KIT</b> OMC GM Small Block V8 305-350cu.in. (1979-1989) and multiple application Ford and GM Risers Used with: Riser: 18-1921</p>	 <p><b>18-8535 (Blocked) MOUNTING KIT</b> Barr, Indmar and Marine Power Ford Small Block V8 302-351cu.in., GM Small Block V8 305-350cu.in., GM Big Block V8 454cu.in. Used with: Risers: 18-1939, 18-1999, and 18-1907</p>
 <p><b>18-8536 MOUNTING KIT</b> Barr, Indmar and Marine Power GM Small Block V8 305-350cu.in. Used with: Manifold: 18-1997-1</p>	 <p><b>18-8538 MOUNTING KIT</b> Barr and Indmar Ford Small Block V8 302-351cu.in. Used with: Manifold: 18-1998-1, 18-1904</p>	 <p><b>18-8553 MOUNTING KIT</b> Used with: Exhaust Elbow: 18-1921</p>
 <p><b>18-2779 EXHAUST HOSE</b> Replaces: 3852696</p>	 <p><b>18-2781 EXHAUST HOSE</b> Replaces: 3852742</p>	 <p><b>18-0114 MANIFOLD END GASKET</b> Replaces: 907761</p>
 <p><b>18-0183 EXHAUST MANIFOLD GASKET</b> Replaces: 908717, 916262, 3852455, 3853742 Use with: Manifold: 18-1958, 18-1962, 18-1904, 18-1998-1, 18-1996, 18-1979</p>	 <p><b>18-0476 (Blocked) RISER GASKET</b> Replaces: Barr 01-0105 Indmar &amp; Marine Power Ford Small Block V8 302-351cu.in. Used with: Risers: 18-1939, 18-1999 and 18-1907</p>	 <p><b>18-0943-1 18-0943-1-9① EXHAUST ELBOW GASKET</b> Replaces: 909786, 3850496 Used with: Riser: 18-1909-1</p>

① Priced per Package

<p>PKG OF 2</p>  <p><b>18-2850</b> <b>18-2850-9<sup>①</sup></b> <b>EXHAUST ELBOW GASKET</b> Replaces: 908935</p>	<p>PKG OF 2</p>  <p><b>18-2854</b> <b>18-2854-9<sup>①</sup></b> <b>EXHAUST RISER GASKET</b> Replaces: Barr 01-0107 Use with: Mounting Kit: 18-8535 Risers: 18-1999, 18-1939, 18-1907</p>	<p>PKG OF 2</p>  <p><b>18-2861</b> <b>18-2861-9<sup>①</sup></b> <b>EXHAUST ELBOW GASKET</b> Replaces: 311121</p>
--	--	--

<p>PKG OF 2</p>  <p><b>18-2875</b> <b>18-2875-9<sup>①</sup></b> <b>EXHAUST ELBOW GASKET</b> Replaces: 3850495, 908013 Used with: Elbow: 18-1922</p>	 <p><b>18-2896</b> <b>MANIFOLD GASKET</b> Replaces: 311068 For GM 4 cyl. 153 cu.in. Early models 110/120 where the carb. linkage mounts to the rear of the engine Use with: Manifold: 18-1904</p>
--	---

<p>PKG OF 2</p>  <p><b>18-2902</b> <b>18-2902-9<sup>①</sup></b> <b>MANIFOLD GASKET</b> Replaces: 909314 Use with: Manifold: 18-1997-1, 18-1986-1, 18-1902, 18-1903</p>	<p>PKG OF 2</p>  <p><b>18-2949</b> <b>18-2949-9<sup>①</sup></b> <b>MANIFOLD GASKET</b> Replaces: Barr CHV-47-000 Use with: Manifold: 18-1997-1</p>
---	--

 <p><b>18-0603</b> <b>EXHAUST MANIFOLD GASKET SET</b> For: Ford 302/351 CID Eng. Use with: Manifold: 18-1998-1</p>	 <p><b>18-0604</b> <b>EXHAUST MANIFOLD GASKET SET</b> For: GM 305/350 CID Eng. Use with: Manifold: 18-1997-1</p>
---	--

① Priced per Package

**MANIFOLD/MANIFOLD GASKET APPLICATION**

Year	Horsepower	Exhaust Manifold	Exhaust Elbow	Manifold Mount Kit	Elbow Mount Kit	Manifold Gasket	Elbow Gasket
1997-98	5.0/5.7L	18-1986-1	18-1909-1	18-8502	18-8507	18-2902	18-0943-1
1994-97	5.8L (Ford)	—	—	—	—	18-0183	18-0943-1
1994-97	7.4L (GM)	—	—	—	—	18-0418	18-0943-1
1991-93	3.0 Liter	—	18-1922	—	—	—	18-2875
1992-93	4.3/4.3 HO	—	18-1909-1	—	18-8507	—	18-0943-1
1993	5.0/5.0 HO/5.8 Liter	—	18-1909-1	—	18-8507	18-0183	18-0943-1
1993	5.0 & 5.8 EFI	—	18-1909-1	—	18-8507	18-0183 ②	18-0943-1
1993	5.0 & 5.8 EFI	—	18-1909-1	—	18-8507	—	18-0943-1
1993	5.8L (Ford)	—	18-1909-1	—	18-8507	18-0183	18-0943-1
1993	7.4L (GM), 8.2L (GM)	—	18-1909-1	—	18-8507	18-0418	18-0943-1
1993	351 King, 454/454 HO/502	—	—	—	—	—	18-0943-1
1992	5.0/5.0 HO/5.8 Liter	—	18-1909-1	—	18-8507	18-0183	18-0943-1
1992	5.8L (Ford)	—	—	—	—	18-0183	18-0943-1
1992	7.4L (GM), 8.2L (GM)	—	—	—	—	18-0418	18-0943-1
1992	351 King Cobra	—	—	—	—	18-0183	18-0943-1
1992	454/454 HO/502	—	—	—	—	—	18-0943-1
1991	4.3/4.3 HO	—	—	—	—	—	18-0943-1
1991	5.8L (Ford), 5.0/5.0 HO/5.8 Liter	—	18-1909-1	—	18-8507	18-0183	18-0943-1

② 5.0L only

APPLICATION CONTINUED ON NEXT PAGE

**MANIFOLD/MANIFOLD GASKET APPLICATION**

Year	Horsepower	Exhaust Manifold	Exhaust Elbow	Manifold Mount Kit	Elbow Mount Kit	Manifold Gasket	Elbow Gasket
1991	454/454 HO	—	18-1909-1	—	18-8507	—	18-0943-1
1991	7.4L (GM)	—	18-1909-1	—	18-8507	18-0418	18-0943-1
1990-91	8.2L (GM)	—	18-1909-1	—	18-8507	—	—
1982-83,1985-90	3.0 Liter	18-1901	18-1922	—	—	—	18-2875
1990	4.3 Liter	—	18-1909-1	—	18-8507	—	—
1990	5.0/5.0 HO/5.8 Liter	—	18-1921	—	—	18-0183	18-0943-1
1990	5.0/5.7L	18-1986-1	18-1909-1	18-8502	18-8507	18-2902	18-0943-1
1990	7.4L (GM)	—	—	—	—	18-0418	18-0943-1
1990	7.5L (Ford)	—	—	—	—	18-0992	18-0943-1
1990	454 King Cobra	—	—	—	—	—	18-0943-1
1987-90	460 King Cobra	—	—	—	—	—	18-0943-1
1989	5.0/5.0 HO/5.8 Liter	—	18-1921	—	18-8534	18-0183	18-0943-1
1989	5.7/350 King Cobra	—	—	—	—	18-2902	18-0943-1
1988	5.0/5.7/350 King Cobra	18-1902 #	18-1921	18-8502	18-8534	18-2902	18-0943-1
1988	5.0/5.7/350 King Cobra	18-1903 *	18-1921	18-8502	18-8534	18-2902	18-0943-1
1988	370 King Cobra	—	—	—	—	—	18-0943-1
1982-87	5.0/5.7 Liter	18-1902 #	18-1921 ①	18-8502	18-8534	18-2902	18-0943-1
1982-87	5.0/5.7 Liter	18-1903 *	18-1921	18-8502	18-8534	18-2902	18-0943-1
1982-86	2.5 Liter	18-1901	18-1922	—	—	18-2896	18-2875
1984	3.0 Liter	18-1901	18-1921	—	18-8534	—	18-2875
1978-81	400 Series, 120 HP	—	—	—	—	18-2896	18-2861
1978-81	400 Series, 140 HP	—	18-1922	—	—	—	18-2875
1981	800 Series, 200,230,260 HP	18-1902 #	18-1921	18-8502	18-8534	18-2902	18-0943-1
1981	800 Series, 200,230,260 HP	18-1903 *	18-1921	18-8502	18-8534	18-2902	18-0943-1
1980	800 Series, 185-260 HP	18-1902 #	18-1921	18-8502	18-8534	18-2902	18-0943-1
1980	800 Series, 185-260 HP	18-1903 *	18-1921	18-8502	18-8534	18-2902	18-0943-1
1979	800 Series,185-230 HP	18-1902 #	18-1921	18-8502	18-8534	18-2902	18-0943-1
1979	800 Series,185-230 HP	18-1903 *	18-1921	18-8502	18-8534	18-2902	18-0943-1
1979	800 Series, 260 HP	18-1902 #	18-1921	18-8502	18-8534	18-2902	18-0943-1
1979	800 Series, 260 HP	18-1903 *	18-1921	18-8502	18-8534	18-2902	18-0943-1
1978	800 Series, 185-225 HP	18-1902 #	18-1921	18-8502	18-8534	18-2902	18-0943-1
1978	800 Series, 185-225 HP	18-1903 *	18-1921	18-8502	18-8534	18-2902	18-0943-1
1978	800 Series, 240 HP	—	18-1921	—	18-8534	—	—
1977	120 HP	—	—	—	—	18-2896	18-0943-1
1977	140 HP	—	18-1922	—	—	—	18-2861
1977	175 THRU 235 HP	—	18-1921	—	18-8534	18-0183	18-2875
1976	120 HP	18-1904	—	—	—	18-0183	18-0943-1
1974-76	140 HP	18-1904	18-1922	—	—	—	18-2861
1976	165 HP	18-1904	18-1922	—	—	18-2830	18-2875
1976	175 THRU 235 HP	18-1904	—	—	—	18-0183	18-2875
1974-75	120 HP	18-1904	—	—	—	18-2896	18-2850
1974-75	165 HP	18-1904	18-1922	—	—	—	18-2875
1975	175 THRU 235 HP	18-1904	—	—	—	18-0183	18-2875
1974	170 & 190 HP	18-1904	—	—	—	18-0183	18-2875
1974	175 THRU 235 HP	18-1904	—	—	—	18-0183	18-2850
1973	100,120,140 HP	—	—	—	—	18-2896	18-2861
1973	165 HP	—	18-1922	—	—	18-2896	18-2861
1972-73	225 & 245 HP	—	—	—	—	—	18-2883
1972	100,120 HP	—	—	—	—	18-2896	18-2861
1972	155 HP	—	—	—	—	N/A	18-2883
1972	165 HP S MODEL, C MODEL	—	—	—	—	—	18-2875
1971	215 & 235 HP	—	—	—	—	—	18-2859
1965-71	120 HP	—	—	—	—	—	18-2861
1967-71	155 HP	—	—	—	—	N/A	18-2859
1968-70	210 HP	—	—	—	—	—	18-2859
1967-68	185 HP	—	—	—	—	—	18-2859
1966-68	200 HP	—	—	—	—	N/A	18-2859
1964-66	150 HP	—	—	—	—	N/A	18-2859
1964	110 HP	—	—	—	—	N/A	18-2859

# Starboard

\* Port

① High rise applications only for 1985

② 5.0L only

OIL FILTERS



Part #	Fits:	O.E.M. #
18-7824-1	GM Engines (Short Filter)	173232, 502902
18-7875	Ford Engines (Long Filter)	173231, 502900
18-7876	GM Engines (Long Filter)	173233, 502901
18-7878-1	M-100, M200 (Short Filter)	502904
18-7879	GM V-6 Engines	173834, 502903



SEE PAGES 152-154 FOR ADDITIONAL INFORMATION

CYLINDER HEAD ASSEMBLIES



**18-4484**  
**CYLINDER HEAD ASSEMBLY**

Replaces: 985080  
Fits: 5.7L V-8 GM (1969-86) with 12 intake manifold mounting bolts, perimeter mount valve cover



**18-4485**  
**CYLINDER HEAD ASSEMBLY**

Fits: 5.7L V-8 GM (1987-95) with press in rocker arm studs with 12 intake manifold mounting bolts- (4 inside intake manifold bolts at 23 degrees), center mount valve covers



**18-4486**  
**CYLINDER HEAD ASSEMBLY**

Fits: 5.7L V-8 GM Vortec (1996-Up) with press in rocker arm studs with 8 intake manifold mounting bolts, composite valve cover



**18-4489**  
**CYLINDER HEAD ASSEMBLY**

Fits: 2.5L/3.0L GM (1968-95)



**18-4491**  
**CYLINDER HEAD ASSEMBLY**

Replaces 4.3L Vortec V-6 (1996-Up) with screw in rocker arm studs (non-adjustable valve train), 8 intake manifold mounting bolts, center mount valve cover. NOTE: not for use with engines using factory roller rocker arms.



**18-4495**  
**CYLINDER HEAD ASSEMBLY**

Replaces: 986086,988163,3854339  
Fits: (1986& Up) 5.0L Ford with D-shape 58 cc combustion chamber



**18-4501**  
**CYLINDER HEAD**

Fits: 5.0L Vortec



**18-4502**  
**CYLINDER HEAD**  
**High Performance**

Aluminum cylinder head sold in pairs only. This utilizes a 185cc intake runner/62cc exhaust runner and 2.02/1.60 stainless valves placed in a 72cc combustion chamber.  
Fits: 5.7, 6.2L GM small block V-8





**18-1400**  
**HYDRAULIC LIFTER**  
 Replaces: 3856127  
 GM 4.3L/V-6 Late/5.0L/5.7L



**18-1401**  
**HYDRAULIC LIFTER**  
 Replaces: 3853847, 985316  
 Ford 5.0L & 5.8L



**18-1402**  
**HYDRAULIC LIFTER**  
 Replaces: 3854033, 502036  
 GM 2.5L/120  
 For: OMC & Volvo 3.0L/181 CID

**ALL PISTONS**  
**ARE SUPPLIED COMPLETE WITH PISTON RINGS AND WRIST PIN.**



**RINGS (Cont.)**

STD	REPLACES OMC / VOLVO
18-3944	370409
<b>.020</b>	
18-3939	3854252
18-3939	914556
<b>.030</b>	
18-3938	*14089026
18-3938	328516
18-3938	914557

**RINGS**

STD	REPLACES OMC / VOLVO
18-3937	*14089025
18-3937	328506
18-3937	3853960
18-3937	914555
18-3937	3853268
18-3937	985083, 986336
18-3940	328536

**PISTONS**

18-4161	3853340
	914816
18-4173	*14077948
18-4173	3911020
<b>.020</b>	
18-4160	3853477, 915236
<b>.030</b>	
18-4164	*14077949
	3911023

\* OMC References GM Number

**PISTON/ RING APPLICATION**

Model	PISTONS			RINGS			Qty. Per Eng.
	Std.	.020	.030	Std.	.020	.030	
<b>OMC</b>							
<b>GM</b>							
2.5L/153 CID	18-4180	18-4183	-	18-3942	-	-	4
3.0L/181 CID	18-4161	18-4160	18-4191	18-3937	18-3939	18-3938	4
1-6/250 CID	-	-	-	18-3942	-	-	6
4.3L/V-6	18-4173	18-4188	18-4164	18-3937	18-3939	18-3938	6
5.0L/305 CID	-	-	18-4178	18-3944	-	-	8
5.7L/350 CID	18-4173	18-4188	18-4164	18-3937	18-3939	18-3938	8
7.4L/454 CID	18-4171	18-4189	18-4172	18-3940	18-3950	18-3941	8
<b>FORD</b>							
5.0L/302 CID	-	-	-	18-3937	18-3939	18-3938	8





**ROD BEARINGS**

Part #	Size	
18-1308	Std.	
18-1309	.010	
18-1327	Std.	
18-1329	Std.	
18-1333	.010	
18-1334	Std.	
18-1337	.010	
18-1341	.020	

Rod bearings sold individually,  
1 per rod



**MAIN BEARINGS**

Part #	Per Eng.	Size		Part #	Per Eng.	Size	
18-1300	①	Std.		18-1316	①	.010	
18-1311	①	Std.		18-1317	①	Std.	
18-1315	①	Std.					

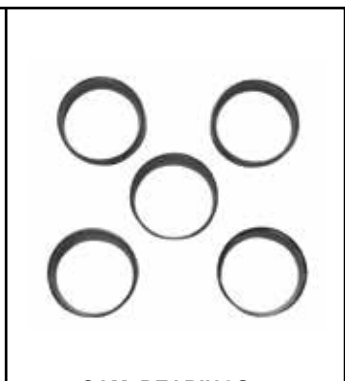

**CAM BEARINGS**

Part #	Per Eng.	
18-1339	1 ①	

① Complete engine set

**BEARING APPLICATION**

Model	ROD BEARING			MAIN BEARING			CAM BEARING
	Std.	.010	.020	Std.	.010	.020	

<b>OMC</b>							
<b>GM</b>							
2.5L/153 CID	18-1329	18-1330	-	18-1317	18-1316	-	18-1339
3.0L/181 CID	18-1308	18-1309	18-1341	18-1317	18-1316	-	18-1339
I-6/230 CID	18-1329	18-1330	-	-	-	-	-
I-6/250 CID	18-1308	18-1309	18-1341	-	-	-	-
4.3L/V-6	18-1327	18-1337	-	18-1311	-	-	-
5.0L/305 CID	18-1308	18-1309	18-1341	18-1300	-	-	-
5.7L/350 CID	18-1308	18-1309	18-1341	18-1300	-	-	-
7.4L/454 CID	18-1334	18-1333	18-1332	18-1315	-	-	-
<b>FORD</b>							
5.0L/302 CID	—	-	-	-	-	-	-



**One Piece Rear Main Seals**

**18-1234**  
Replaces:  
3853528

**18-0519**  
Replaces  
3852657, 912957



**Two Piece Rear Main Seals**

**18-0528**  
Replaces:  
913745

**18-1211**  
Replaces:  
473424



**Timing Cover Seals**

**18-1213**  
Replaces:  
3853341  
912989, 914817

**18-1230**  
Replaces:  
3853827

**18-1233**  
Replaces: 3860095

**OMC SEAL APPLICATION**

Engine Model	2 Piece Rear Main Crankshaft Seal Conv. Rotation (LH)	Timing Cover Seal
<b>GM</b>		
2.5L/153 CID	18-1211 ②	18-1213
3.0L/181 CID	18-1211 ②	18-1213
I-6/230CID	18-1211 ②	18-1213
I-6/250CID	18-1211 ②	18-1213
4.3L/V-6	18-1211 ②	18-1213
5.0L/305 CID	18-1211 ①	18-1213
5.7L/350 CID	18-1211 ①	18-1213
7.4L/454 CID	③	18-1233
<b>FORD</b>		
5.0L/302 CID	18-0528	
5.8L/351 CID	—	18-1230

① Large Journal Crankshaft GM Engines    ② For One Piece Seal (LH) Models Use 18-0519    ③ For One Piece Seal (LH) Models Use 18-1234

MISCELLANEOUS GASKETS/GASKET SETS



**18-0465**  
**INTAKE MANIFOLD GASKET SET**  
 Replaces: 352670  
 For: GM 454 CID Engines, 325, 330, 340, 350 HP  
 and 454 Magnums, 7.4L

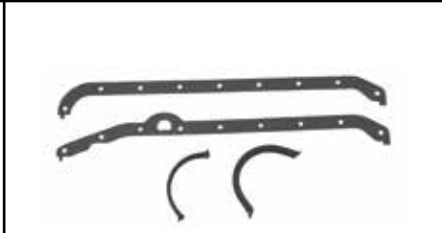

**18-0153**  
**OIL PAN GASKET SET**  
 Replaces:  
 393159, 458625, 357159  
 For: OMC 5.7L



**18-0340**  
**OIL PAN GASKET SET**  
 Replaces: 508713



**18-1239**  
**OIL PAN GASKET**  
 Replaces: 914820  
 For: OMC 3.0L



**18-0348**  
**OIL PAN GASKET SET**  
 Replaces: 3931593, 508871

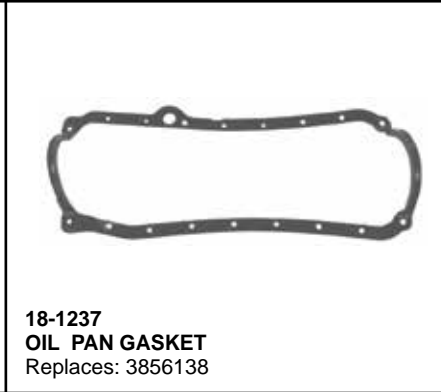

**18-1237**  
**OIL PAN GASKET**  
 Replaces: 3856138



**18-0466**  
**OIL PAN GASKET SET**  
 Replaces: 393061, 3923440, 3921473

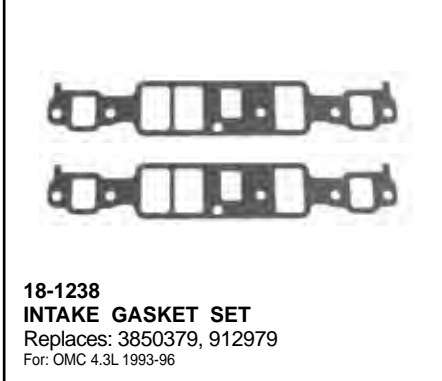

**18-1238**  
**INTAKE GASKET SET**  
 Replaces: 3850379, 912979  
 For: OMC 4.3L 1993-96

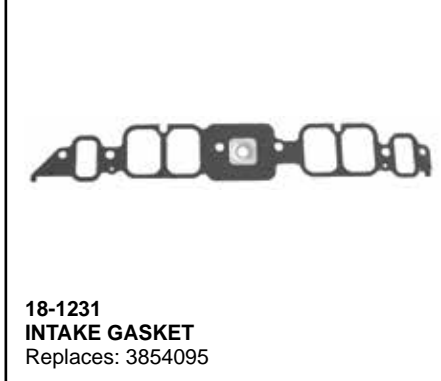

**18-1231**  
**INTAKE GASKET**  
 Replaces: 3854095



**18-0405**  
**OIL PAN GASKET**  
 Replaces:  
 3852655, 912955  
 For: OMC 4.3L



**18-0407**  
**OIL PAN GASKET SET**  
 Replaces: 508872



**18-0410**  
**INTAKE MANIFOLD GASKET SET**  
 Replaces:  
 988162, 3854406, 986103,  
 3853912, 986104, 3853913  
 For: OMC 5.0L & 5.8L (1989-96)



**18-0411**  
**OIL PAN GASKET SET**  
 Replaces:  
 458625, 357159, 508876



**18-1232**  
**OIL PAN GASKET**  
 Replaces: 3853510



**18-0868**  
**INTAKE MANIFOLD GASKET SET**  
 Replaces:  
 985630, 3854269  
 For: OMC 5.7L 1994, 1996-97



Display Package

**18-2613**  
**OUTDRIVE GASKET SET**  
 Replaces: 508105

— CONTAINS —

Part #	Description	O.E. #	Qty.
18-2918	Outdrive Gasket	911836	1
18-2996	Outdrive Seal	911823	1
18-7153	O-Ring	911851	2

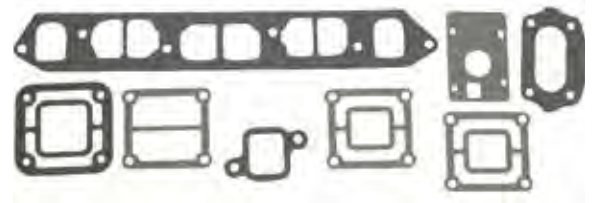

**18-4369**  
**EXHAUST MANIFOLD GASKET SET**  
 For: 2.5L (1985-86) and 3.0L (1985-88)



**18-2699**  
**OUTDRIVE GASKET**  
 For: SX Drives  
 Use 18-3721 Mounting Nuts

— CONTAINS —

Part #	Description	O.E. #	Qty.
18-7153	O-Ring	911851	2
18-2996	Outdrive Seal	911823	1



**18-4370**  
**EXHAUST MANIFOLD GASKET SET**  
 For: 100, 120 HP and 2.5L (1965-85)

— CONTAINS —

Part #	Description	O.E. #	Qty.
18-0114	Manifold End Cap Gasket	907761	1
18-2896	Exhaust Manifold Mounting Gasket	311068	1
18-0104	Exhaust Elbow Gasket	907764	1
18-0164	Thermostat Housing Gasket	311069	1
18-0937	Carb. Mtg. Gasket	315055	1
18-2861	Manifold End Cap Gasket	311121	3
18-2875	Elbow To Manifold Gasket	908013	1
18-2858	Thermostat Cover Housing Gasket	314809	1

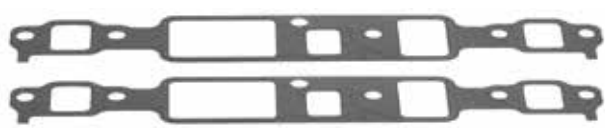

**18-4408**  
**INTAKE MANIFOLD GASKET SET**  
 Replaces: 912978  
 For: GM 4.3L

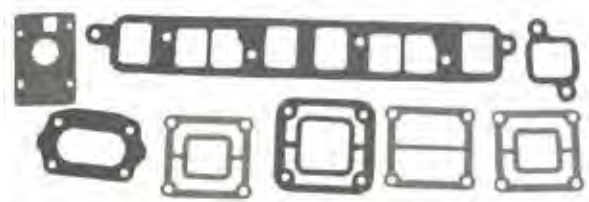

**18-4371**  
**EXHAUST MANIFOLD GASKET SET**  
 For: 140 HP and 3.0L (1973-84)

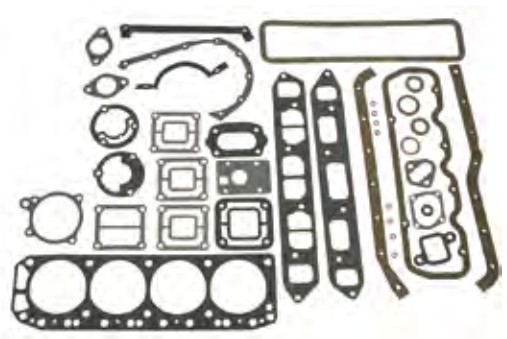

**18-4373**  
**OVERHAUL GASKET SET**  
 For: 110, 120 HP and 2.5L (1965-86)

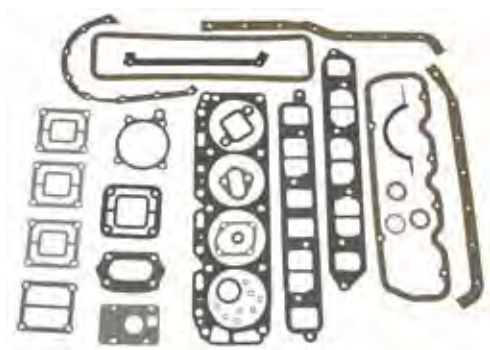











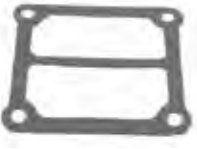







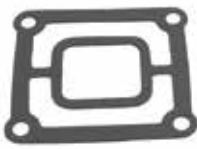

**18-4374**  
**OVERHAUL GASKET SET**  
 For: 140 HP and 3.0L (1973-88)

 <p><b>18-2946</b> <b>HEAD GASKET</b> Replaces: 3853336, 908611 For: GM 181 (3.0L) CID Eng.</p>	 <p><b>18-3874</b> <b>HEAD GASKET</b> Replaces: 3853511 For: (8.2L) 502 CID</p>	 <p><b>18-3876</b> <b>HEAD GASKET</b> Replaces: 3853380, 914971 For: GM 305 (5.0L)/350 (5.7L) CID Eng.</p>	 <p><b>18-3877</b> <b>HEAD GASKET</b> Replaces: 914849 For: GM 454 (7.4L) CID Eng.</p>
 <p><b>18-3878</b> <b>HEAD GASKET</b> Replaces: 912766 For: Mercruiser 224 (3.7L) CID Eng. Model 470</p>	 <p><b>18-3879</b> <b>HEAD GASKET</b> Replaces: 3854299, 912227, 914930 For: GM 262 (4.3L) CID Eng.</p>	 <p><b>18-3880</b> <b>HEAD GASKET</b> Replaces: 311210 For: GM 153 (2.5L), (3.0L) CID Eng.</p>	 <p><b>18-3881</b> <b>HEAD GASKET</b> Replaces: 908237 For: GM 250 (4.1L) CID (6 cyl) Eng.</p>
 <p><b>18-3883</b> <b>HEAD GASKET</b> Replaces: 3853732 For: Ford 302 (5.0L) 351 (5.8L) CID Eng.</p>	 <p><b>18-3887</b> <b>HEAD GASKET</b> Replaces: 915325 For: (7.4L) 454 CID GEN V</p>	 <p><b>18-0434</b> <b>CARB MOUNTING GASKET</b> Replaces: 909758</p>	<p>PKG OF 2</p>  <p><b>18-5399</b> <b>18-5399-9①</b> <b>DISTRIBUTOR CAP GASKET</b> Replaces: 910169</p>
<p>PKG. OF 2</p>  <p><b>18-0874</b> <b>18-0874-9①</b> <b>DISTRIBUTOR GASKET</b> For GM V6 &amp; V8 Replaces: 3852109, 312780 For: 2.6L (1989), 3.5L (1989), 4.3L (1987-93), 5.0L (1987-88), 5.7L (1987-92), 7.4L (1988-93), 8.2L (1992-93)</p>	<p>PKG. OF 2</p>  <p><b>18-0937</b> <b>18-0937-9①</b> <b>CARB MOUNTING GASKET</b> Replaces: 315055</p>	 <p><b>18-0435</b> <b>CARB MOUNTING GASKET</b> Replaces: 908765</p>	<p>PKG. OF 2</p>  <p><b>18-0876</b> <b>18-0876-9①</b> <b>FUEL PUMP GASKET</b> For GM 4.3L, 5.0L &amp; 5.7L Replaces: 3852113, 312800</p>
<p>PKG. OF 2</p>  <p><b>18-0164</b> <b>18-0164-9①</b> <b>THERMOSTAT GASKET</b> 4 &amp; 6 Cyl. Replaces: 311069 GM 3789161</p>	<p>PKG. OF 2</p>  <p><b>18-0929</b> <b>18-0929-9①</b> <b>THERMOSTAT GASKET</b> Replaces: 313416</p>	<p>PKG. OF 2</p>  <p><b>18-2858</b> <b>18-2858-9①</b> <b>THERMOSTAT GASKET</b> Replaces: 314809</p>	<p>PKG. OF 2</p>  <p><b>18-2917</b> <b>18-2917-9①</b> <b>THERMOSTAT GASKET</b> Replaces: 312797, 3701777 (GM)</p>

SEE PAGES 166-167 FOR OUR COMPLETE LINE OF GASKET SEALANTS

① Priced per Package

<p>PKG. OF 2</p>  <p><b>18-2947</b> <b>18-2947-9①</b> <b>THERMOSTAT GASKET</b> Replaces: 310913</p>	<p>PKG. OF 2</p>  <p><b>18-0104</b> <b>18-0104-9①</b> <b>EXHAUST ELBOW GASKET</b> Replaces: 907764</p>	<p>PKG. OF 2</p>  <p><b>18-0114</b> <b>MANIFOLD END GASKET</b> Replaces: 907761 For GM 4 Cyl.</p>	<p>PKG. OF 2</p>  <p><b>18-4431</b> <b>18-4431-9①</b> <b>EXHAUST ELBOW GASKET</b> Replaces: 913783</p>
 <p><b>18-0430</b> <b>EXHAUST ELBOW GASKET</b> Replaces: 912477</p>	<p>PKG. OF 2</p>  <p><b>18-0673</b> <b>18-0673-9①</b> <b>EXHAUST ELBOW GASKET</b> Replaces: 910113</p>	<p>PKG. OF 2</p>  <p><b>18-0943-1</b> <b>18-0943-1-9①</b> <b>EXHAUST ELBOW GASKET</b> Replaces: 909786, 3850496</p>	<p>PKG. OF 2</p>  <p><b>18-2850</b> <b>18-2850-9①</b> <b>MANIFOLD END CAP GASKET</b> Replaces: 908935</p>
<p>PKG. OF 2</p>  <p><b>18-2859</b> <b>18-2859-9①</b> <b>MANIFOLD END CAP GASKET</b> Replaces: 311131</p>	<p>PKG. OF 2</p>  <p><b>18-2860</b> <b>18-2860-9①</b> <b>MANIFOLD END CAP GASKET</b> Replaces: 311130</p>	<p>PKG. OF 2</p>  <p><b>18-2861</b> <b>18-2861-9①</b> <b>MANIFOLD END CAP GASKET</b> Replaces: 311121</p>	<p>PKG. OF 2</p>  <p><b>18-2875</b> <b>18-2875-9①</b> <b>EXHAUST ELBOW GASKET</b> Replaces: 908013, 3850495</p>
<p>PKG. OF 2</p>  <p><b>18-2883-1</b> <b>18-2883-1-9①</b> <b>MANIFOLD END CAP GASKET</b> Replaces: 907775</p>	 <p><b>18-2541</b> <b>RUBBER SEAL</b> Replaces: 911704</p>	 <p><b>18-0401</b> <b>EXHAUST MANIFOLD GASKET</b> Replaces: 913393 For Ford 140 CID (2.3L)</p>	 <p><b>18-0431</b> <b>INTAKE MANIFOLD GASKET</b> Replaces: 912471 For Ford 140 CID (2.3L)</p>
 <p><b>18-0956</b> <b>EXHAUST MANIFOLD GASKET</b> Replaces: 912405 460 CID</p>	 <p><b>18-2912</b> <b>EXHAUST MANIFOLD GASKET</b> Replaces: 908079</p>	<p>PKG. OF 2</p>  <p><b>18-2830</b> <b>EXHAUST MANIFOLD GASKET</b> Inline 6 cyl. Replaces: 907932</p>	 <p><b>18-2896</b> <b>EXHAUST MANIFOLD GASKET</b> Replaces: 311068</p>

① Priced per Package

<p>PKG. OF 2</p>  <p><b>18-2909</b> <b>18-2909-9<sup>①</sup></b> <b>EXHAUST MANIFOLD GASKET</b> Replaces: 915025 GM V-6</p>	 <p><b>18-0183</b> <b>EXHAUST MANIFOLD GASKET</b> Replaces: 3853742, 3852455, 908717, 916262 For: OMC 5.0L &amp; 5.8L (1993-96)</p>	 <p><b>18-0680</b> <b>EXHAUST MANIFOLD GASKET</b> Replaces: 3853256, 914578</p>	 <p><b>18-0418</b> <b>EXHAUST MANIFOLD GASKET</b> Replaces: 909613</p>
<p>PKG. OF 2</p>  <p><b>18-1204</b> <b>18-1204-9<sup>①</sup></b> <b>EXHAUST MANIFOLD GASKET</b> Replaces: 912164</p>	 <p><b>18-0892</b> <b>DEFLECTOR HOSE</b> Replaces: 322411</p>	 <p><b>18-0664</b> <b>VALVE COVER GASKET</b> Replaces: 913270, 3852687 For: GM 305/350, 5.0 &amp; 5.7L</p>	 <p><b>18-2845</b> <b>VALVE COVER GASKET</b> Replaces: 912965 For GM 305/350 CID (5.0L and 5.7L)</p>
 <p><b>18-0311</b> <b>VALVE COVER GASKET</b> Replaces: 3854942 For: 4.3 Litre 262 CID</p>	 <p><b>18-0346</b> <b>VALVE COVER GASKET</b> Replaces: 3930912 For: GM 250 CID (4.1L), 160/165/200 (6 cyl.)</p>	 <p><b>18-0347</b> <b>VALVE COVER GASKET</b> Replaces: 3852693, 912981, 913277 For: GM 153 &amp; 181 CID (2.5L &amp; 3.0L)</p>	<p>PKG. OF 2</p>  <p><b>18-0464</b> <b>18-0464-9<sup>①</sup></b> <b>VALVE COVER GASKET</b> Replaces: 912768 For: GM 454/502 CID (7.4L &amp; 8.2L)</p>
 <p><b>18-0352</b> <b>VALVE COVER GASKET</b> Replaces: 913758 For: Ford 302/351 CID (5.0L &amp; 5.8L)</p>	 <p><b>18-0548</b> <b>ADAPTER TO INTERMEDIATE HOUSING GASKET</b> Replaces: 909515</p>	<p>PKG. OF 2</p>  <p><b>18-0947</b> <b>18-0947-9<sup>①</sup></b> <b>PIVOT CAP COVER GASKET</b> Replaces: 909529</p>	<p>PKG. OF 2</p>  <p><b>18-0440</b> <b>18-0440-9<sup>①</sup></b> <b>WATER PASSAGE GASKET</b> Replaces: 915719</p>
 <p><b>18-0911</b> <b>WATER PUMP GASKET</b> Replaces: 911698</p>	<p>PKG. OF 2</p>  <p><b>18-0903</b> <b>WATER PUMP GASKET</b> Replaces: 3853361 454 CID</p>	 <p><b>18-0147</b> <b>WATER PUMP GASKET</b> For Ford V-8 Replaces: 3852824</p>	 <p><b>18-0327</b> <b>WATER PUMP GASKET</b> Replaces: 3853342 4 &amp; 6 Cyl.</p>

<p>PKG. OF 2</p>  <p><b>18-2916</b> <b>18-2916-9①</b> <b>WATER PUMP HOUSING GASKET</b> Replaces: 911702</p>	 <p><b>18-0939</b> <b>18-0939-9①</b> <b>UPPER GEARCASE DIPSTICK GASKET</b> Replaces: 315189</p>	 <p><b>18-0468</b> <b>TIMING COVER GASKET</b> Replaces: 3853512, 912954, 3852654, 915326 For: OMC 2.6L, 3.5L (1989), 4.3L (1987-93), 5.0L (1987-88), 5.7L (1987-92, 1994, 1996)</p>	<p>PKG. OF 2</p>  <p><b>18-0891</b> <b>18-0891-9①</b> <b>WATER PUMP MOUNTING GASKET</b> Replaces: 3852477, 909835 For: GM 4.3L, 5.0L &amp; 5.8L</p>
<p>PKG. OF 2</p>  <p><b>18-0893</b> <b>18-0893-9①</b> <b>WATER PUMP BACK-IN PLATE GASKET</b> Replaces: 3850595 GM 4.3L, 5.0L &amp; 5.7L</p>	<p>PKG. OF 2</p>  <p><b>18-0322</b> <b>18-0322-9①</b> <b>REAR SEAL GASKET</b> Replaces: 3852656 GM 5.0L &amp; 5.7L</p>	 <p><b>18-0329</b> <b>PUSH ROD/LIFTER COVER GASKET</b></p>	<p>PKG. OF 2</p>  <p><b>18-0887</b> <b>18-0887-9①</b> <b>TIMING COVER GASKET</b> Replaces: 3852691, 912988, 913275 4 &amp; 6 Cyl.</p>
 <p><b>18-0980</b> <b>TIMING COVER GASKET</b> Replaces: 3935449 GM 7.4L</p>	<p>PKG. OF 2</p>  <p><b>18-0880</b> <b>18-0880-9①</b> <b>SHIFT COVER GASKET</b> Replaces: 911878</p>	<p>PKG. OF 2</p>  <p><b>18-0166</b> <b>18-0166-9①</b> <b>GROMMET</b> Replaces: 911705</p>	 <p><b>18-2815</b> <b>PUSH ROD COVER GASKET</b> Replaces: 3852692, 913276 For: 3.0L</p>
 <p><b>18-0190</b> <b>WIPER GASKET</b> Replaces: 912157</p>	<p>PKG. OF 2</p>  <p><b>18-2851</b> <b>18-2851-9①</b> <b>SWIVEL BEARING GASKET</b> Replaces: 313368</p>	<p>PKG. OF 2</p>  <p><b>18-2863</b> <b>18-2863-9①</b> <b>TILT CLUTCH COVER GASKET</b> Replaces: 308799</p>	<p>PKG. OF 2</p>  <p><b>18-2911</b> <b>18-2911-9①</b> <b>SWIVEL BEARING HOUSING GASKET</b> Replaces: 910236</p>

① Priced per Package



<p>PKG. OF 5</p>  <p><b>18-2918</b> <b>18-2918-9<sup>①</sup></b> <b>OUTDRIVE GASKET</b> Replaces: 911836, 915840</p>	<p>PKG. OF 5</p>  <p><b>18-2996</b> <b>18-2996-9<sup>①</sup></b> <b>OUTDRIVE SEAL</b> Replaces: 911823, 3852560</p>	<p>PKG. OF 2</p>  <p><b>18-0923</b> <b>18-0923-9<sup>①</sup></b> <b>RUBBER SEAL</b> Replaces: 313244</p>	<p>PKG. OF 2</p>  <p><b>18-0188</b> <b>18-0188-9<sup>①</sup></b> <b>WASHER</b> Replaces: 909748</p>
 <p><b>18-2387</b> <b>18-23871-9<sup>①</sup></b> (PKG. OF 50) <b>LOWER UNIT DRAIN SCREW</b> Replaces: 307551 Fits: OMC V-6, V-4(1979 &amp; Up), 60-75hp 3 cylinder, 20-35hp (1985-97)</p>	 <p><b>18-1236</b> <b>DRAIN SCREW</b> Replaces: 309243 For Cobra Drives &amp; V-6 40-50HP (1989-97)</p>	 <p><b>18-2378</b> <b>18-23781-9<sup>①</sup></b> (PKG. OF 50 without washer) <b>MAGNETIC DRAIN SCREW</b> Replaces: 318544 Fits: Cobra 2.3, 3.0, 3.8 &amp; 5.8L (1986-92), V-6, V-4(1979 &amp; Up), 60-75hp 3 cyl, 40/50hp (1989-98)</p>	<p>PKG. OF 5</p>  <p><b>18-4253-9<sup>①</sup></b> <b>18-42531-9<sup>①</sup></b> (PKG. OF 50) <b>DRAIN SCREW O-RING</b> Replaces: 336982 Used w/ 18-1236 Drain Screw</p>
<p>PKG. OF 2</p>  <p><b>18-2945</b> <b>18-2945-9<sup>①</sup></b> <b>DRAIN SCREW GASKET</b> Replaces: 307552</p>	 <p><b>18-8369</b> <b>OIL INDICATOR WITH WASHER</b> Replaces: 914488 Fits: OMC Cobra (1986-93) without cone clutch</p>	<p>PKG. OF 5</p>  <p><b>18-4248</b> <b>18-4248-9<sup>①</sup></b> <b>18-42481-9<sup>①</sup></b> (PKG. OF 50) <b>DRAIN/FILL PLUG WASHER (Plastic)</b> Replaces: 311598</p>	<p>PKG. OF 5</p>  <p><b>18-4250</b> <b>18-4250-9<sup>①</sup></b> <b>WASHER</b> Replaces: 911820</p>
 <p><b>18-0549</b> <b>PLUG OFF CAP</b> Replaces: 909829 I.D. 1" For V-8 Model Stern Drives and Inboards (1977 to present)</p>	 <p><b>18-0550</b> <b>PLUG OFF CAP</b> Replaces: 909830 I.D. 1 1/4" For V-8 Model Stern Drives and Inboards 1977 to present</p>	 <p><b>18-0518</b> <b>VALVE STEM SEAL</b> Replaces: 3854956, 914323, 3853132 For: most inline 4 and 6 cyl. GM (Early) and 305-350 CID GM</p>	<p>PKG. OF 8</p>  <p><b>18-4024</b> <b>18-4024-9<sup>①</sup></b> <b>VALVE STEM SEAL</b> Replaces: 3853226, 914445 For: Chevy 4.3L/5.0L/5.7L</p>

① Priced per Package

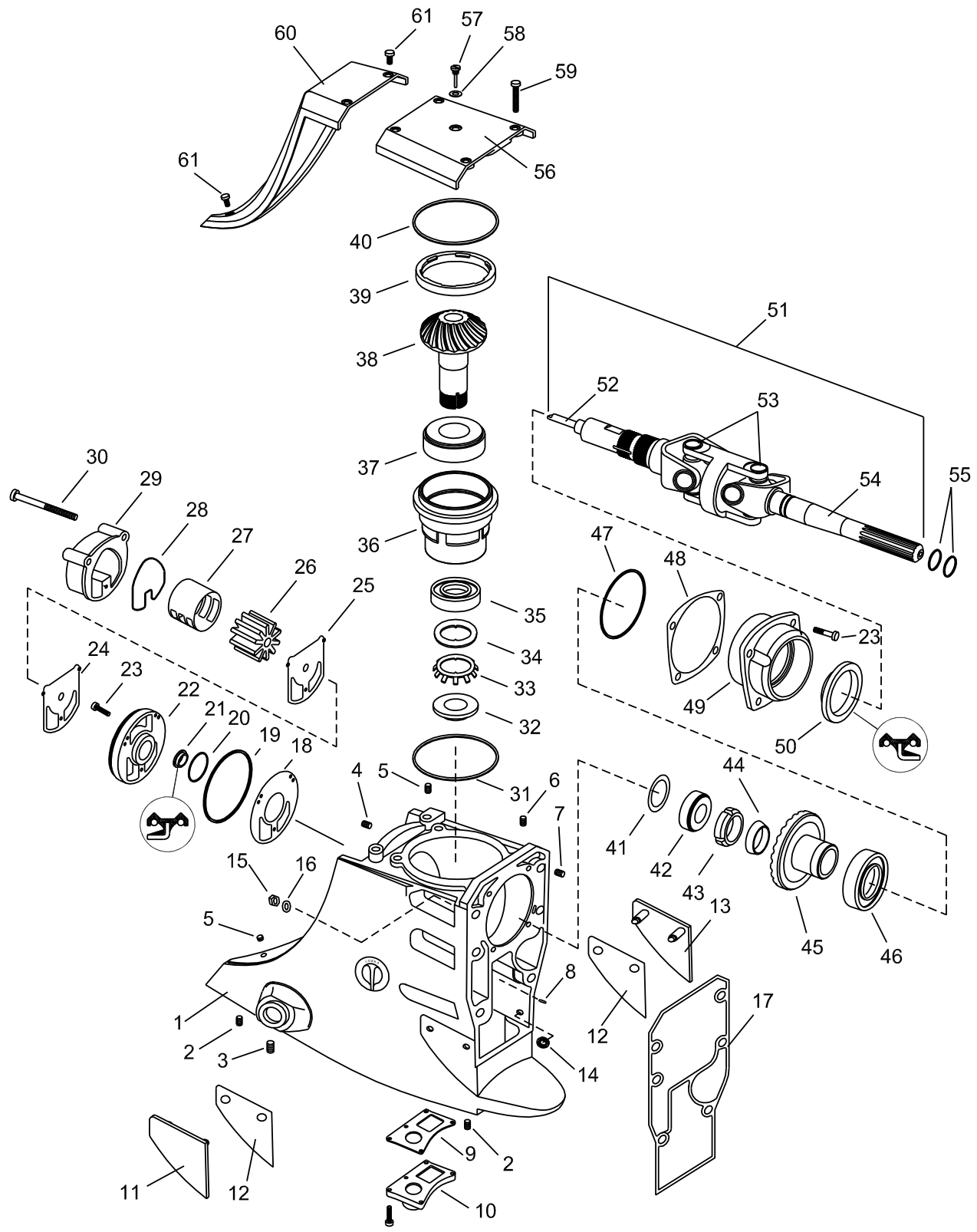

Figure #	Description	Part #	O.E.M. #	Qty.	Figure #	Description	Part #	O.E.M. #	Qty.	
1	Upper Gear Housing, Basic w/ Inserts	~	984518	1	32	Pinion Nut	18-3769	911753	1	
					33	Nut Retainer	18-3610	911752	1	
2	Gearcase Insert	NSS	910935	5	34	Pinion Washer	NSS	911697	1	
3	Gearcase Insert	NSS	911779,	5	35	Pinion Bearing, Lower	18-1170	983892	1	
			3852541		36	Bearing Carrier, Pinion	18-4828	911750	1	
4	Gearcase Insert	NSS	910901	5	37	Pinion Bearing, Upper	18-1161	983891	1	
5	Gearcase Insert	NSS	911858,	3	38	Gear Set, 21:16 (includes 38 & 45)	18-1600	983825	AR	
			3852567		38	Gear Set, 21:18 (includes 38 & 45)	18-1601	983826	AR	
6	Gearcase Insert	NSS	910901	4	38	Gear Set, 21:19 (includes 38 & 45)	18-1602	984012	AR	
7	Gearcase Insert	NSS	910901	4						
8	Shift Rod Guide	NSS	912137	1	39	Retainer Ring, Pinion Housing	18-3768	911751	1	
9	Gasket, Water Passage Cover	18-0884	911733	1	40	O-Ring, Gear Housing Cover	18-7107	313175	1	
10	Water Passage Cover	18-4837	911734	1						
11	Thrust Plate, Starboard	NSS	911838,	1	41	Shim, Gear Position, 0.003"	18-02062	911662	AR	
			3852562		41	Shim, Gear Position, 0.005"	18-02063	911663	AR	
12	Shim, Thrust Plate, 0.015"	18-1713	911839,	AR	41	Shim, Gear Position, 0.007"	18-02064	911664	AR	
			3852563		41	Shim, Gear Position, 0.010"	18-02065	911665	AR	
13	Thrust Plate, Port	NSS	911837,	1	41	Shim, Gear Position, 0.012"	18-02066	911666	AR	
			3852561		41	Shim, Gear Position, 0.015"	18-02067	911667	AR	
14	Retainer Ring, Thrust Plate	NSS	910953	4	42	Bearing, U-Joint Shaft	18-1171	983878	1	
15	Nut	18-3730	912920,	6	43	Nut, Gear to U-Joint	18-3770	911937	1	
			3852648		44	Centering Cone	18-4835	912029	1	
16	Washer	NSS	911833	6	45	Gear Set, 21:16 (includes 38 & 45)	18-1600	983825	AR	
17	Gasket, Outdrive Mounting	18-2918	911836,	1						
18	Gasket, Adapter to Gear Housing	18-0911	911698	1	45	Gear Set, 21:18 (includes 38 & 45)	18-1601	983826	AR	
19	O-Ring, Adapter, Large	18-7407	911700	1						
20	O-Ring, Adapter, Small	18-7403	909316	1	45	Gear Set, 21:19 (includes 38 & 45)	18-1602	984012	AR	
21	Water Pump Shaft Seal	18-2068	911701,	1						46
			915702,		47	O-Ring, Bearing Carrier	18-7169	911686	1	
22	Adapter, Water Pump to Gear Housing	18-4836	916058,	1	48	Shim, Bearing Carrier, 0.003", Green	18-0227	911678	AR	
			3853655							48
23	Screw	18-1598	908668,	6	48	Shim, Bearing Carrier, 0.005", Blue	18-02060	911680	AR	
			341013							48
24	Gasket, Plate to Adapter	18-2916	911702	1	49	Gear Bearing Carrier	18-4838	911683	1	
25	Plate, Water Pump	18-3121	911703	1	50	Seal, Bearing Carrier	18-2067	911685	1	
26	Impeller	18-3058	983895,	1	51	U-Joint & Water Pump Shaft Assy	18-2338	983880	1	
			777128							52
27	Liner, Water Pump Cover	18-3145	911844	1	53	U-Joint Assy	18-2104	912214	2	
28	Seal, Water Pump Housing	18-2541	911704	1	54	Yoke Shaft	18-2146	912212	1	
29	Impeller Housing	18-3206	984744	1						
30	Screw	NSS	912238	3	55	O-Ring, U-Joint Shaft	18-7153	911851,	3852565	
31	Shim, Bearing Carrier 0.010	18-0207	911668	AR						56
			911669,		57	Oil Indicator	18-8369	914488	1	
31	Shim, Bearing Carrier 0.001	18-0209	911670,	AR						58
			611671,		59	Screw, Gear Housing Cover	18-1599	123018	4	
31	Shim, Bearing Carrier 0.003	18-0211	911672,	AR						60
			911673,		61	Screw, Water Pump Access Cover	18-4749-9	911859,	3852568	
31	Shim, Bearing Carrier 0.003	18-0211	911674,	AR						
			911675,							
31	Shim, Bearing Carrier 0.003	18-0211	911676,	AR						
			911677							

AR As required

NSS Not Sold Seperate



**SCREWS**

Part No.	OE No.	Application
18-1280	317763	115-235 HP (1980-87) Cobra Drives (w/O-Ring)
18-1598	341013	Fits: OMC Cobra (1986-93) without cone clutch
18-1599	123018	Fits: OMC Cobra (1986-93) without cone clutch
18-3135	306643	Cobra Drives
18-4749-9 <sup>①</sup>	3852568	For Cover Assembly: (3 Pack) Fits: 2.3L (1987-90), 2.5L (1986), 2.6L (1989), 3.0L (1986-93), 4.3L (1986-93), 5.0L (1986-94), 5.7L (1986-92), 5.8L (1989-93), 7.4L (1988)

<sup>①</sup> PKG of 3, priced per package

**GEAR HOUSINGS**

Part No.	OE No.	Description	Application
18-4804	984770, 986381	Upper Gear Housing Complete, 21: 16 Ratio	5.7L(1986-93), 5.8L(1986-89,1991-93)
18-4805	984771, 986382	Upper Gear Housing Complete, 21: 18 Ratio	2.5L (1986-89), 3.0L(1986-93), 5.0L(1989-93)
18-4806	984765, 986380	Upper Gear Housing Complete, 21: 19 Ratio	4.3L, 3.0L high altitude OMC Cobra (1986-93)



**SHIMS**

Part No.	O.E. No.	Size	Part No.	O.E. No.	Size
18-0207 <sup>①</sup>	911668	0.010	18-02064 <sup>①</sup>	911664	0.007
18-0209 <sup>①</sup>	911669, 911670, 911671, 911672, 911673, 911674, 911675, 911676, 911677	0.001	18-02065 <sup>①</sup>	911665	0.010
18-0211 <sup>①</sup>	911669, 911670, 911671, 911672, 911673, 911674, 911675, 911676, 911678	0.003	18-02066 <sup>①</sup>	911666	0.012
			18-02067 <sup>①</sup>	911667	0.015
			18-2229	323362	0.003
			18-2230	323361	0.004
18-2231	314745	0.005			
18-0227 <sup>① ②</sup>	911678	0.003	<sup>①</sup> Fits: OMC Cobra (1986-93) without cone clutch <sup>②</sup> Green <sup>③</sup> Tan <sup>④</sup> Blue <sup>⑤</sup> Brown <sup>⑥</sup> Kit includes 1 each of 18-2229, 18-2230 & 18-2231		
18-0229 <sup>① ③</sup>	911679	0.004			
18-1713 <sup>①</sup>	3852563	0.015			
18-1718 <sup>⑥</sup>	-	Kit			
18-02060 <sup>① ④</sup>	911680	0.005			
18-02061 <sup>① ⑤</sup>	911681	0.010	NOTE: For shim sizes larger than .010" use shim 18-0207 and appropriate combination of .001" shim (18-0209), and .003" shim (18-0211) to reach desired shim thickness.		
18-02062 <sup>① ⑤</sup>	911662	0.003			
18-02063 <sup>①</sup>	911663	0.005			



**18-9876 SHIM GAUGE TOOL**  
Replaces: 349957



**18-4442 ENGINE ALIGNMENT TOOL**  
Used to verify engine alignment on Cobra models.

**MARINE GRADE 316 STAINLESS STEEL WORM GEAR HOSE CLAMPS**



All components are manufactured from Marine Grade 316 stainless steel. These clamps are designed to fit many applications from 5/16" to 7" diameter hoses.

**STAINLESS STEEL CLAMPS**

Part #	Diameter Size	Std. #	Part #	Diameter Size	Std. #
18-7307	5/16" to 7/8"	006	18-7313	1 3/16" to 2 1/2"	032
18-7308	9/16" to 1 1/16"	010	18-7314	2 9/16" to 3 1/2"	048
18-7309	9/16" to 1 1/4"	012	18-7315	2 1/2" to 4 1/2"	064
18-7310	1 1/16" to 1 1/2"	016	18-7316	3" to 5"	072
18-7311	3/4" to 1 3/4"	020	18-7317	5" to 7"	104
18-7312	1 1/16" to 2"	024			



**18-2100 LINK BELT HEAVY DUTY GIMBAL BEARING**  
Replaces: 983937  
Fits all OMC Cobra and King Cobra Drives



**18-3763 SHIFT SHAFT**  
Replaces: 322941  
For: V-4/V-6, Cobra, Stringer



**18-2337 STUB SHAFT**  
Replaces: 3850814  
Fits: All Cobra 1994-Up except King Cobra



**18-6399**  
**SHAFT & STUB ASSEMBLY**  
 Replaces: 984264  
 For: Cobra Drives- 232, 302(1986-90), 252(1986), 262, 350, 460(1989), 432, 434, 502(1986-92), 504(1986-88), 574(1986-92), 584(1989-93), 754(1987-88)



**18-2104**  
**U-JOINT**  
 Heavy Duty  
 Replaces: 912214, 915716  
 Fits OMC Cobra Drives (1986-89) Includes straight grease fitting and 90° fitting (Rockwell)



**18-2174**  
**U-JOINT**  
 Heavy Duty  
 Replaces: 915717, 3850812  
 Fits OMC Cobra and King Cobra Drives (1990 & ABOVE) Includes straight grease fitting and 90° fitting. (Rockwell)



**18-2338**  
**U-JOINT**  
 Replaces: 983880  
 For: 1986-93 OMC Cobra



**18-2339**  
**U-JOINT ASSEMBLY**  
 Replaces: 3852384  
 Fits: All Cobra 1994-Up except King Cobra



**18-2146**  
**UNIVERSAL YOKE ASSEMBLY**  
 Replaces: 912212, 3850815  
 For: All Cobra (1986-Up)



**18-3770**  
**U-JOINT NUT**  
 Replaces: 911937  
 For: 232, 252, 262, 302, 350, 432, 434, 460, 502, 504, 574, 584, 744, 754, (1987-93)

Year	Model		U-joint #	U-joint Assy. OE #	Long Yoke #	Long Yoke OE #	Short Yoke #	Short Yoke OE #
1986	2.3L, 3.0L, 4.3L, 5.7L	②	18-2338	983880	18-2146	912212	18-6399	984264
1987-88	2.3L, 3.0L, 4.3L, 5.0L, 5.7L, 7.5L	②	18-2338	983880	18-2146	912212	18-6399	984264
1989	2.3L, 3.0L, 4.3L, 5.0L, 5.7L, 5.8L, 7.5L	②	18-2338	983880	18-2146	912212	18-6399	984264
1990	2.3L, 3.0L, 4.3L, 5.0L, 5.7L, 5.8L	②	18-2338	983880	18-2146	912212	18-6399	984264
1990	5.7L, 7.4L, 7.5L	③	N/A	986191	18-2146	912212	N/A	914646
1991	3.0L, 4.3L, 5.7L, 5.8L	②	18-2338	983880	18-2146	912212	18-6399	984264
1991	7.4L	③	N/A	986191	18-2146	912212	N/A	914646
1992-93	3.0L, 3.2L, 4.3L, 5.0L, 5.7L, 5.8L	②	18-2338	983880	18-2146	912212	18-6399	984264
1992-93	3.0L, 3.2L, 4.3L, 5.0L, 5.7L, 5.8L, 7.4L, 8.2L	③	N/A	986191	18-2146	912212	N/A	914646
1994	3.0L, 4.3L, 5.0L, 5.7L, 5.8L	①③	18-2339	3852384	18-2146	3850815	18-2337	3850814
1994	5.8L, 7.4L	③④	N/A	3853937	18-2146	3850815	N/A	3853563
1995	3.0L, 4.3L, 5.0L, 5.8L	③	18-2339	3852384	18-2146	3850815	18-2337	3850814
1995	7.4L	③	N/A	3853937	18-2146	3850815	N/A	3853563
1996	3.0L, 4.3L, 5.0L, 5.7L, 5.8L, 7.4L	③	18-2339	3852384	18-2146	3850815	18-2337	3850814
1997	3.0L, 4.3L, 5.7L, 7.4L	③	18-2339	3852384	18-2146	3850815	18-2337	3850814
1998	3.0L, 4.3L, 5.0L, 5.7L, 7.4L, 8.2L	③	18-2339	3852384	18-2146	3850815	18-2337	3850814

① Excludes Model 58FBPMDA    ② Used where raw w/p is located on outdrive    ③ Used where raw w/p is located on engine    ④ Includes Model 58FBPMDA



**18-2772-1**  
**TRANSOM SEAL KIT**  
 For: SX Cobra Drives with cone clutch

— CONTAINS —

Part #	Description	O.E. #	Qty.
18-2100	Gimbal Bearing	3853807	1
18-2765	Bellows	3854127	1
18-1074	Bellows	3850426-2	1
18-2996	Seal	3852560, 911823	1
18-7315	Hose Clamp	853012-3	1



**18-2771**  
**BELLOWS KIT**  
 For: OMC Cobra without cone clutch

— CONTAINS —

Part #	Description	O.E. #
18-2613	Outdrive Gasket Set	—
18-2765	U-Joint Bellows	983973, 987467
18-2764	Exhaust Bellows	914036
18-2763	Shift Cable Bellows	911826
18-2100	Gimbal Bearing	983937
18-7315	Hose Clamp	—



**18-2128  
CENTER SOCKET**  
Replaces:  
912213, 3850813  
Fits all OMC Cobra



**18-2745  
EXHAUST BOOT**  
Replaces: 912374  
Fits 5.7L & 7.5L (1986 & later)



**18-1074  
EXHAUST BELLOW**  
Replaces: 3850426  
All cone clutch models (1994-up)  
not using exhaust boot



**18-2763  
SHIFT CABLE  
BELLOWS**  
Replaces: 911826  
ALL COBRA



**18-2764  
EXHAUST BELLOWS**  
Replaces: 914036  
All clutch dog Cobra models  
(1986-93)



**18-2765  
U-JOINT BELLOWS**  
Replaces: 983973,  
987467, 3854127  
All clutch dog Cobra models (1986-93)



**18-21754  
ENGINE COUPLER**  
Replaces: 986232, 984537  
Fits: 7.5L / 460 King Cobra 1987-90



**18-21751  
ENGINE COUPLER**  
Replaces: 3853962,  
983902, 986338  
Fits: 2.5L (1986), 3.0L (1986-90), (4.3L,  
5.0L, 5.7L) (1986) KW & KWB suffix only,  
7.4L (1990-98), 8.2L (1992-93, 1998)



**18-21752-1  
ENGINE COUPLER**  
Replaces: 3858437, 984290,  
986120, 3853917  
Fits: 4.3L (1986-98), 5.0L (1986-88, 1998)  
5.7 (1986-92, 1994, 1996-98)



**18-21753  
ENGINE COUPLER**  
Replaces: 3853862  
Fits: 5.0L & 5.8L (1989-96)



**18-21755  
ENGINE COUPLER**  
Replaces: 984629  
2.3L Cobra



**18-2533  
TRANSOM SEAL**  
Replaces: 911797



**18-2767  
TRANSOM SEAL**  
Replaces: 313080  
(1967-77) 120 HP and UP



**18-2768  
TRANSOM SEAL**  
Replaces: 909527  
(1978-86) — ALL



**18-2245-1  
SHIFT CABLE  
ASSEMBLY**  
Replaces: 987661  
For: 1988-1993 OMC Cobra (except King)  
without cone clutch



**18-2246  
SHIFT CABLE ASSEMBLY**  
Replaces: 987678  
For: King Cobra



**18-2178  
BALL GEAR KIT**  
(1973-86)

— CONTAINS —

Part #	Desc.	O.E. #	Qty.	Part #	Desc.	O.E. #	Qty.
18-7121	O-Ring	308621	1	18-3725	Locknut	908064	2
18-4251	Plug	908062	2	18-7401	O-Ring	908383	1
18-2176	Ball Gear	908063	1	18-2071	Oil Seal	981195	2
18-2177	Ball Gear	908069	1	18-2072	Oil Seal	981196	2

 <p><b>18-2176 BALL GEAR (Intermediate Housing)</b> Replaces: 908063 (1973-86)</p>	 <p><b>18-2177 BALL GEAR (Upper Gearcase)</b> Replaces: 908069 1973-86</p>	 <p><b>18-3769 PINION NUT</b> Replaces: 911753 For: 115 (1994-97), 232 (1987-90), 252 (1986), 262, 350, 460 (1989), 302, 574 (1986-92), 432 (1986-93), 502 (1988-93), 504, 754 (1986-88), .584 (1989-93), 744 (1988), 90 Jet (1994-95)</p>	 <p><b>18-3719 PINION NUT</b> Replaces: 314730 (5/8 - 18)</p>	
<p>PKG. OF 5</p>  <p><b>18-3725 18-3725-9① BALL GEAR NUT</b> Replaces: 908064</p>	<p>PKG. OF 2</p>  <p><b>18-3731 18-3731-9① LOCKNUT</b> Replaces: 907866 3/4 - 16</p>	<p>PKG. OF 5</p>  <p><b>18-4251 18-4251-9① PLUG</b> Replaces: 908062 O.D. 1.748</p>	 <p><b>18-4835 CENTERING CONE</b> Replaces: 912029 Fits: OMC Cobra (1986-93) without cone clutch</p>	 <p><b>18-1154 BALL BEARING</b> Replaces: 377139</p>
 <p><b>18-1161 TAPERED ROLLER BEARING</b> Replaces: 983891</p>	 <p><b>18-1170 LOWER PINION BEARING</b> Replaces: 983892</p>	 <p><b>18-1171 U-JOINT SHAFT BEARING</b> Replaces: 983878</p>	 <p><b>18-1172 CARRIER BEARING</b> Replaces: 983877 For: 1986-95 Cobra</p>	
 <p><b>18-1158 CARRIER BEARING</b> Replaces: 387247</p>	 <p><b>18-1350 CARRIER BEARING</b> Replaces: 379504</p>	 <p><b>18-1351 CARRIER BEARING</b> Replaces: 382407 COBRA</p>	 <p><b>18-1117 PINION BEARING</b> Replaces: 387817</p>	 <p><b>18-1357 PINION BEARING</b> Replaces: 384195 COBRA</p>
 <p><b>18-1358 REVERSE GEAR BEARING</b> Replaces: 389039 COBRA</p>	 <p><b>18-1365 THRUST BEARING</b> Replaces: 387656 COBRA DRIVE SHAFT</p>	 <p><b>18-1366 THRUST BEARING</b> Replaces: 382408 COBRA REVERSE GEAR</p>	 <p><b>18-1370 THRUST FORWARD BEARING</b> Replaces: 389042</p>	 <p><b>18-1371 THRUST FORWARD BEARING</b> Replaces: 385043 COBRA</p>



① Priced per Package



**OMC 400 & 800 SERIES GEARCASE BEARINGS**



HP	Year	Pinion Bearing	Drive Shaft Bearing	Carrier Aft Bearing	Carrier Fore Bearing	Forward Thrust Bearing	Reverse Thrust Bearing	Housing Bearing
120	1978-81	18-1357	18-1365	18-1350	18-1351	18-1371	18-1366	—
2.5L	1982-86	18-1357	18-1365	18-1350	18-1351	18-1371	18-1366	18-1351
140	1978-81	18-1357	18-1365	18-1350	18-1351	18-1371	18-1366	—
3.0L	1982-86	18-1357	18-1365	18-1350	18-1351	18-1371	18-1366	18-1351
185/3.8L	1978-85	18-1117	18-1365	18-1158	18-1351	18-1370	18-1366	18-1358
4.3L	1985-86	18-1117	18-1365	18-1158	18-1351	18-1370	18-1366	18-1358
200/5.0L	1979-86	18-1117	18-1365	18-1158	18-1351	18-1370	18-1366	18-1358
225	1978	18-1117	18-1365	18-1158	18-1351	18-1370	18-1366	18-1358
230/530L	1979-86	18-1117	18-1365	18-1158	18-1351	18-1370	18-1366	18-1358
240	1978	18-1117	18-1365	18-1158	18-1351	18-1370	18-1366	18-1358
250	1979	18-1117	18-1365	18-1158	18-1351	18-1370	18-1366	18-1358
260/5.7L	1979-86	18-1117	18-1365	18-1158	18-1351	18-1370	18-1366	18-1358

**OMC COBRA GEAR HOUSING BEARINGS**

HP	Year	Pinion Bearing	Drive Shaft Bearing	Carrier Aft Bearing	Carrier Fore Bearing	Forward Thrust Bearing	Reverse Thrust Bearing	Housing Bearing
2.3L	1987	18-1357	18-1365	18-1350	18-1351	18-1371	18-1366	18-1351
2.3L	1988-90	18-1357	18-1365	18-1350	18-1351	18-1371	18-1366	—
2.5L	1986	18-1357	18-1365	18-1350	18-1351	18-1371	18-1366	18-1351
3.0L	1986-87	18-1357	18-1365	18-1350	18-1351	18-1371	18-1366	18-1351
3.0L	1988-89	18-1357	18-1365	18-1350	18-1351	18-1371	18-1366	—
3.0L	1990-91	18-1117	18-1365	18-1158	18-1351	18-1370	18-1366	—
3.0L/3.0L HO	1992-93	18-1117	18-1365	—	18-1351	18-1370	18-1366	—
4.3L	1986-87	18-1117	18-1365	18-1158	18-1351	18-1370	18-1366	18-1358
4.3L	1988-91	18-1117	18-1365	18-1158	18-1351	18-1370	18-1366	—
4.3L/4.3L HO	1992-93	18-1117	18-1365	—	18-1351	18-1370	18-1366	—
5.0L	1986-87	18-1117	18-1365	18-1158	18-1351	18-1370	18-1366	18-1358
5.0L	1988-91	18-1117	18-1365	18-1158	18-1351	18-1370	18-1366	—
5.0L/5.0L HO	1992-93	18-1117	18-1365	—	18-1351	18-1370	18-1366	—
5.7L	1986-87	18-1117	18-1365	18-1158	18-1351	18-1370	18-1366	18-1358
5.7L	1988-91	18-1117	18-1365	18-1158	18-1351	18-1370	18-1366	—
5.7L	1992-93	18-1117	18-1365	—	18-1351	18-1370	18-1366	—
5.8L	1989-91	18-1117	18-1365	18-1158	18-1351	18-1370	18-1366	—
5.8L	1992-93	18-1117	18-1365	—	18-1351	18-1370	18-1366	—

 <b>18-0195</b> <b>THRUST WASHER</b> Replaces: 314731 COBRA	 <b>18-0198</b> <b>FORWARD GEAR THRUST WASHER</b> Replaces: 324766	PKG. OF 2  <b>18-2243</b> <b>18-2243-9<sup>①</sup></b> <b>DETENT BALL</b> Replaces: 316506 For: V-4 & V-6 gearcase OMC Sterndrive 400 Series (1978-79); 800 Series (1978)
--	--	--

 <b>18-1501</b> <b>DETENT BALL</b> Replaces: 160084 For: Cobra drives (1980& Earlier)	 <b>18-1732</b> <b>DRIVE SHAFT RETAINER</b> Replaces: 338504 For: V4 & V6 driveshafts
--	--

 <b>18-1701</b> <b>LOWER DRIVE SHAFT</b> Replaces: 911693 For: Cobra Drives 262, 302, 350, 432, 434, 502, 504, 574, 584	 <b>18-2183</b> <b>DRIVE SHAFT</b> Replaces: 909121
---	--

① Priced per Package





**18-2184**  
**DRIVE SHAFT**  
Replaces: 908087



**18-2185**  
**DRIVE SHAFT**  
Replaces: 909753



**18-2186**  
**DRIVE SHAFT**  
Replaces: 982424  
800 Drives



**18-2187**  
**PROP SHAFT**  
Replaces: 395209  
Cobra & Late Model 800 Drives



**18-2251**  
**PROP SHAFT**  
Replaces: 435022, 433017, 436740



**18-2252**  
**PROP SHAFT**  
Replaces: 387818, 436888



**18-2216**  
**SLIDING CLUTCH**  
Replaces: 337772, 337774,  
334516, 336562, 910995



**18-2220**  
**SLIDING CLUTCH**  
Replaces: 323664, 320630



**18-2383**  
**SLIDING CLUTCH**  
Replaces: 914716, 915272  
For: 3.0L (GM), 4.3L (GM), 5.0L (Ford), 5.7L (Ford),  
5.8L (Ford) (1990-91)



**18-2218**  
**FORWARD GEAR SET**  
Replaces: 434063, 987966,  
985050, 436746



**18-2219**  
**REVERSE GEAR**  
Replaces: 333077,  
317838, 340490



**18-1600**  
**UPPER GEAR KIT**  
**with bearing**  
Replaces: 983825  
For: 5.7, 5.8L V-8 Cobra drives (21:16 ratio)



**18-1601**  
**UPPER GEAR KIT**  
**with bearing**  
Replaces: 983826  
For: 5.0L V-8 engines-Cobra drives (21:18 ratio)



**18-1602**  
**UPPER GEAR KIT**  
Replaces: 984012  
For: 4.3L V-6 engines-Cobra drives (21:19 ratio)



**18-2217**  
**GEAR SET**  
—CONTAINS—

Part #	Desc.	O.E.#
NSS	Forward Gear	435020
NSS	Reverse Gear	910994
18-2216	Sliding Clutch	337772

APPLICATION BEGINS ON NEXT PAGE

**SHAFT/GEAR/SLIDING CLUTCH APPLICATION**

Model	Year	Bearing Carrier Shaft	Short/Long Water Pump Shaft	Drive Shaft	Prop Shaft	Forward Gear	Reverse Gear	Sliding Clutch
100 thru 165	1973	—	18-2185	—	—	—	—	—
120 thru 190	1974-75	—	18-2185	—	—	—	—	—
120 thru 235 ⑥	1976-77	—	18-2184	—	—	—	—	—
120 thru 190 ⑤	1976	—	18-2185	—	—	—	—	—
120/140 ⑤	1977	—	18-2185	—	—	—	—	—
120/140	1978-81	18-2183	18-2185	—	18-2252	—	—	18-2220
120 thru 235 ⑥	1977	—	18-2184	—	—	—	—	—
175/190/235 ⑤	1977	18-2183	18-2185	—	—	—	—	—
185	1978	18-2183	18-2185	18-2186	—	—	—	—
185	1980-81	18-2183	18-2185	18-2186	—	—	—	—
200	1979	18-2183	18-2185	18-2186	—	—	—	—
200	1980-81	18-2183	18-2185	18-2186	—	—	—	—
225/245	1973-75	—	18-2184	—	—	—	—	—
225	1978	18-2183	18-2185	18-2186	—	—	—	—
225	1979	—	—	18-2186	—	—	—	—
225	1980	—	—	18-2186	—	—	—	—
225	1981	—	—	18-2186	—	—	—	—
230	1979	18-2183	18-2185	18-2186	—	—	—	—
230	1980-81	18-2183	18-2185	18-2186	—	—	—	—
235	1975	18-2183	18-2185	—	—	—	—	—
235 ⑤	1976-77	18-2183	18-2185	—	—	—	—	—
240	1978	18-2183	18-2185	18-2186	—	—	—	—
240	1979	—	—	18-2186	—	—	—	—
240	1980-81	—	—	18-2186	—	—	—	—
250	1979	18-2183	18-2185	18-2186	—	—	—	—
260	1979	18-2183	18-2185	18-2186	—	—	—	—
260	1980-81	18-2183	18-2185	—	—	—	—	—
262	1989	—	—	—	18-2187	—	—	—
2.3/3.0	1987-89	—	—	—	18-2252	—	18-2219	—
2.3	1990	—	—	—	18-2252	—	—	—
2.5	1986	18-2183	18-2185	—	18-2252	—	18-2219	—
2.5	1982-87	18-2183	18-2185	—	18-2252	18-2218	18-2219	—
350 ③	1988-89	—	—	—	18-2187	18-2218	—	—
3 ①	1982-86	18-2183	18-2185	—	18-2252	18-2218	18-2219	18-2216
3.0/4.3 ③	1990-91	—	—	—	18-2187	—	—	18-2383
3.0/4.3	1992-93	—	—	—	18-2251	—	—	18-2383
3.0 H.O.	1990-91	—	—	—	18-2187	—	—	18-2383
3.0 H.O.	1992-93	—	—	—	18-2251	—	—	18-2383
3.8	1982-86	18-2183	18-2185	18-2186	18-2187	—	—	18-2216
460 ③	1988-89	—	—	—	18-2187	—	—	18-2216
4.3 ①	1985-86	18-2183	18-2185	18-2186	18-2187	—	—	18-2216
4.3 ②	1986-87	—	—	—	18-2187	—	—	—
4.3 ③	1988-91	—	—	—	18-2187	—	—	18-2383 ⑨
4.3 H.O.	1990-91	—	—	—	18-2187	—	—	18-2383
4.3 H.O.	1992-93	—	—	—	18-2251	—	—	18-2383
5.0/5.7	1982-83	18-2183	18-2185	18-2186	—	—	—	18-2216
5.0/5.7 ①	1984-86	18-2183	18-2185	18-2186	18-2187	—	—	18-2216
5 ②	1986-87	—	—	—	18-2187	—	—	—
5	1988	—	—	—	18-2187	—	—	—
5 ③	1988-91	—	—	—	18-2187	—	—	18-2383 ⑨
5.0/5.7	1992	—	—	—	18-2251	—	—	18-2383
5.0 H.O.	1990-91	—	—	—	18-2187	—	—	18-2383
5.0 H.O.	1992-93	—	—	—	18-2251	—	—	18-2383
5.7	1987-88	—	—	—	18-2187	—	—	—
5.7 ③	1988-89	—	—	—	18-2187	—	—	—
5.7 ⑧ ③	1990-92	—	—	—	18-2187	—	—	18-2383
5.8 ③	1989-90	—	—	—	18-2187	—	—	18-2383 ⑨
5.8	1991	—	—	—	18-2187	—	—	18-2383
5.8	1992-93	—	—	—	18-2251	—	—	18-2383
7.5	1987	—	—	—	18-2187	—	—	18-2216

① Except Cobra  
② Cobra

③ Right hand rotation drive  
⑤ Low profile

⑥ High profile  
⑧ Except L.E. models

⑨ 1990-93 models only



**18-3767 BEARING ASSEMBLY & HOUSING**  
Replaces: 389455  
For: V-4, V-6 Cobra Stringer



**18-1702 CARRIER BEARING**  
Replaces: 438039, 5000074  
For: 1 3/16" diameter prop shaft-Cobra drives (1986-90) Fits all stringer mounts except 2.5L & 3.0L (1978-85)



**18-1703 CARRIER BEARING**  
Replaces: 434400, 435096, 438040, 5000363, 5004257  
For: 1 1/4" diameter prop shaft Cobra drives (1991-93)



**18-4828**  
**PINION BEARING CARRIER**  
 Replaces: 911750  
 Fits: OMC Cobra (1986-93) without cone clutch



**18-1099**  
**BEARING HOUSING & SEAL ASSEMBLY**  
 Replaces: 982422  
 For: OMC Stringer Drive-120, 140, 170, 200, 230, 260, (1981), 252, 302, 382, 502, 504 & 574 (1982-85), 432 (1985)



**18-1343**  
**BEARING CARRIER RETAINING TAB**  
 Replaces: 333957  
 For: Cobra drives & V-6



**18-0655**  
**SHIFT ROD**  
 Replaces: 914736  
 3.0L (1990-1993), 4.3L, 5.0L, 5.7L, 5.8L (1986-1993)



**18-0647**  
**SHIFT ROD ASSEMBLY**  
 Replaces: 986658  
 3.0L (1990-1993), 4.3L, 5.0L, 5.7L, 5.8L (1986-1993)



**18-0652**  
**ROD END, SHIFT**  
 Replaces: 914723  
 3.0L (1990-1993), 4.3L, 5.0L, 5.7L, 5.8L (1986-1993)



**18-0653**  
**SCREW, SHIFT ROD END**  
 Replaces: 308825  
 3.0L (1990-1993), 4.3L, 5.0L, 5.7L, 5.8L (1986-1993)



**18-0654**  
**NUT, SHIFT ROD END**  
 Replaces: 914743  
 3.0L (1990-1993), 4.3L, 5.0L, 5.7L, 5.8L (1986-1993)



**18-3766**  
**SHIFT CRADLE**  
 Replaces: 334163  
 For: V-4/V-6, Cobra, Stringer



**18-3610**  
**RETAINER NUT**  
 Replaces: 911752  
 Fits: OMC Cobra (1986-93) without cone clutch



**18-3768**  
**COVER NUT**  
 Replaces: 911751  
 For: Cobra Drives 115 (1994-97), 232 (1987-90), 252 (1986) 262 (1989), 302 (1987)



**18-1500**  
**INTAKE WATER SCREEN**  
 Replaces: 337778  
 For: 100, 120, 125, 140, 150, 175, 200, 225 (1993) (OMC Cobra & V6)



**18-4750**  
**COVER ASSEMBLY**  
 Replaces: 983967  
 Fits: 2.3L (1987-90), 2.5L (1986), 2.6L (1989), 3.0L (1986-93), 4.3L (1986-93), 5.0L (1986-94), 5.7L (1986-92), 5.8L (1989-93), 7.4L (1988)



**18-1714**  
**CLUTCH DOG PIN**  
 Replaces: 313448  
 For: 50-85, 100, 135, 140, 150, 175, 200, 235 (1969-82) (OMC Stringer drive)



**18-2399**  
**CLUTCH DOG**  
Replaces: 324369  
For: V-4 & V-6



**18-4222**  
**THRUST WASHER**  
Replaces: 318841



**18-4223**  
**THRUST WASHER**  
Replaces: 333592



**18-4228**  
**PROP SPACER**  
Replaces: 315810



**18-4194**  
**PROP SPACER**  
Replaces: 3852350  
For: 1994 King Cobra Lower Units



**18-4231**  
**PROP SPACER**  
Replaces: 320570



**18-3705**  
**18-3705-9①**  
**PROP NUT**  
Replaces: 314503



**18-3708-1**  
**PROP NUT & KEEPER**  
Replaces: 398042



**18-3730**  
**LOCK NUT**  
Replaces: 3852648  
For: Cobra & King Cobra 1987-94



**18-3733**  
**PROP NUT KIT**  
For: SX Cobra



**18-3715**  
**PROP NUT KIT**

— CONTAINS —

Part #	O.E. #	Description
18-3708-1	398042	Prop Nut/Keeper
18-3741	309955	Cotter Pin
18-4231	320570	Prop Spacer



**18-3716**  
**PROP NUT KIT**  
Replaces: 175267

— CONTAINS —

Part #	O.E. #	Description
18-3705	314503	Prop Nut
18-3742	314502	Cotter Pin
18-4238	315810	Prop Spacer



**18-4444**  
**PROP WRENCH**  
FOR ALL COBRA



**18-2156**  
**TILT SHAFT**  
Replaces: 980183  
I/O 1964-86  
EXCEPT COBRA



**18-3741**  
**18-3741-9①**  
**COTTER PINS**  
Replaces: 309955

**18-3742**  
**18-3742-9①**  
Replaces: 314502



**18-9098**  
**TRAILERING CLIPS**  
Replaces: 174448  
Set of 2  
For all Cobra Stern Drives



APPLICATION BEGINS ON NEXT PAGE

① Priced per Package

② Items ending in "D" are Display Packaged - Regular number is Non-Display

## NUT/SPACER/WASHER/COTTER PIN/PROP NUT KIT APPLICATION

Model	Year	Nut	Spacer	Washer	Cotter Pin	Prop Nut Kit	Model	Year	Nut	Spacer	Washer	Cotter Pin	Prop Nut Kit
120	1978-81	18-3705	18-4228	18-4222	18-3742	18-3716	460	1989-90	18-3708-1	18-4231	18-4223	18-3741	18-3715
140	1978-81	18-3705	18-4228	18-4222	18-3742	18-3716	502	1992	18-3708-1	18-4231	18-4223	18-3741	18-3715
185	1978-80	18-3708-1	18-4231	18-4223	18-3741	18-3715	2.3	1987-90	18-3705	18-4228	18-4222	18-3742	18-3716
200	1979-81	18-3708-1	18-4231	18-4223	18-3741	18-3715	2.5	1982-86	18-3705	18-4228	18-4222	18-3742	18-3716
225	1978	18-3708-1	18-4231	18-4223	18-3741	18-3715	3	1982-89	18-3705	18-4228	18-4222	18-3742	18-3716
230	1979	18-3708-1	18-4231	18-4223	18-3741	18-3715	3	1990-92	18-3708-1	18-4231	18-4223	18-3741	18-3715
240	1978	18-3708-1	18-4231	18-4223	18-3741	18-3715	3.8	1981-85	18-3708-1	18-4231	18-4223	18-3741	18-3715
260	1979-81	18-3708-1	18-4231	18-4223	18-3741	18-3715	4.3	1985-92	18-3708-1	18-4231	18-4223	18-3741	18-3715
262	1987-89	18-3708-1	18-4231	18-4223	18-3741	18-3715	5	1982-92	18-3708-1	18-4231	18-4223	18-3741	18-3715
350	1988-91	18-3708-1	18-4231	18-4223	18-3741	18-3715	5.7	1979-92	18-3708-1	18-4231	18-4223	18-3741	18-3715
351	1992	18-3708-1	18-4231	18-4223	18-3741	18-3715	5.8	1989-92	18-3708-1	18-4231	18-4223	18-3741	18-3715
454	1990-92	18-3708-1	18-4231	18-4223	18-3741	18-3715	7.5	1987	18-3708-1	18-4231	18-4223	18-3741	18-3715

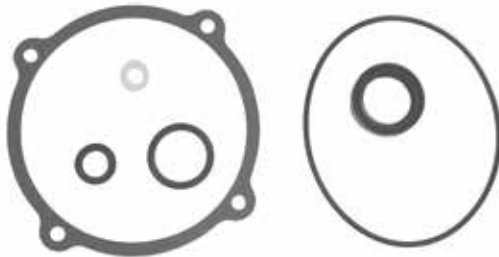

**18-2698**  
**CLUTCH HOUSING SEAL KIT**

Fits: All models 1977 & below

— CONTAINS —

Part #	Desc.	O.E. #	Qty.
18-7114	O-RING	302540	1
18-7400	O-RING	908194	1
18-7952	OIL SEAL	911019	1
18-2863	GASKET, COVER	308799	1
18-4248	GASKET, OIL DRAIN	311598	1
18-0939	GASKET, DIPSTICK	315189	1



**18-8360**  
**CLUTCH HOUSING SEAL KIT**

Fits: All models 1978 & above

— CONTAINS —

Part #	Desc.	O.E. #	Qty.
18-2060	OIL SEAL	321467	2
18-7114	O-RING	302540	1
18-7168	O-RING	202893	2
18-7400	O-RING	908194	1
18-2863	GASKET, COVER	308799	1
18-4248	GASKET, OIL DRAIN	311598	2
18-0939	GASKET, DIPSTICK	315189	1

HP	Year	Clutch Pack Seal Kit	HP	Year	Clutch Pack Seal Kit	HP	Year	Clutch Pack Seal Kit	HP	Year	Clutch Pack Seal Kit
80	1968-1969	18-2698	140	1980-1981	18-8360 <sup>③</sup>	190	1974-1977	18-2698	230	1980-1981	18-8360 <sup>②</sup>
90	All	18-2698	3.0L	1982-1985	18-8360	200	1966-1968	18-2698	235	All	18-2698
100	1972-1973	18-2698	155	1967-1972	18-2698	200	1979-1980	18-2698 <sup>①</sup>	240	1978	18-2698
120	1965-1978	18-2698	165	1972-1976	18-2698	200	1980-1981	18-8360 <sup>②</sup>	245	1972-1975	18-2698
120	1979-1980	18-2698 <sup>①</sup>	3.8L	1981-1983	18-8360	5.0L	1982-1985	18-8360	250	1979	18-2698
120	1980-1985	18-8360 <sup>③</sup>	170	1974	18-2698	210	1968-1970	18-2698	260	1979-1980	18-2698 <sup>①</sup>
2.5L	1982-1985	18-8360	175	1975-1977	18-2698	215	1971	18-2698	260	1980-1981	18-8360 <sup>②</sup>
140	1973-1978	18-2698	185	1967-1968	18-2698	225	All	18-2698	5.7L	1982-1985	18-8360
140	1979-1980	18-2698 <sup>①</sup>	185	1978	18-2698	230	1979-1980	18-2698 <sup>①</sup>			

① 1980 Models with the "C" suffix

② 1980 Models with "K" or "U" suffix

③ 1980 Models with "C1" suffix

**Zinc is for saltwater only applications.**  
**Magnesium is for fresh water only applications.**  
**Aluminum is for brackish water, or if boat is used in both fresh and salt environments.**



**⑤ 18-6019**  
**ANODE**  
Replaces: 982277, 982438  
For intermediate housing on  
Stringer Drive models



**⑤ 18-6020**  
**ANODE**  
Replaces: 976669  
For Stringer Drive models with central  
grounding point on boat hull



**⑤ 18-6024**  
**④ 18-6024A**  
**ANODE**  
Replaces: 393023, 436745  
(1982-87) For use on gearcases



**⑤ 18-6025**  
**ANODE**  
Replaces: 433458, 398331

④ Aluminum

⑤ Zinc



③ **18-6027**  
**ANODE**  
 Replaces: 392123  
 For exhaust housing,  
 V4 & V6 (1983-90)



③ **18-6028**  
 ① **18-6028A**  
 ② **18-6102**  
**ANODE**  
 Replaces: 984513,  
 3853818, 3855412  
 For use on Gearcases: 2.3L (1987-90),  
 2.6L/3.5L/4.6L (1989), 3.0L/4.3L/5.0L/5.8L  
 (1987-93), 5.7L (1987-92), 7.4L (1987-88)



③ **18-6029**  
**ANODE**  
 Replaces: 397768



③ **18-6095**  
 ① **18-6095A**  
**ANODE**  
 Replaces: 431708  
 For use on gearcases (1988-90)



③ **18-6101**  
**ANODE**  
 Replaces: 983494  
 For: Cobra Lower Unit (1987)  
 2.5, 3.0, 4.3, 5.0, 5.7



③ **18-6103**  
 ① **18-6103A**  
**ANODE**  
 Replaces: 984547  
 For use on Transom Mounts:  
 2.3L/3.0L (1987-89), 2.6L (1989)



③ **18-6155Z**  
**ANODE KIT**  
 For: Cobra Drives except King Cobra

PKG. OF 5



**18-3722**  
**18-3722-9**④  
**STAINLESS STEEL LOCKNUT**  
 Replaces: 121731  
 (1/4"—28)



**18-2138**  
**PIVOT PIN BEARING**  
 Replaces: 911787  
**COBRA**  
**(2 per Drive)**



**18-7634**  
**TRIM SENDER**  
 Replaces: 984748  
 Fits: OMC Cobra



**18-2663**  
**LOWER UNIT**  
**SEAL KIT**  
 Replaces: 981797  
 100-245 Stringer Unit (1968-77)

— CONTAINS —

Part #	Desc.	O.E. #	Qty.
18-0168	Grommet	908594	1
18-2012	Oil Seal	310599	4
18-2020	Oil Seal	310649	1
18-2058	Oil Seal	313353	2
18-2851	Swivel Bearing To Lower Gear Case Gsk.	313368	1
18-4248	Washer	311598	2
18-7120	O-Ring	307853, 322598	4
18-7129	O-Ring	314491	1
18-7135	O-Ring	310584	1
18-7167	O-Ring	310414	1



**18-2664**  
**LOWER UNIT**  
**SEAL KIT**  
 Replaces: 982947  
 4 cyl (400) Stringer Unit (1978-86)

— CONTAINS —

Part #	Desc.	O.E. #	Qty.
18-0110	Shift Housing Gasket	324670	1
18-3133	Housing Screw	908158	2
18-0188	Washer	909748	1
18-2020	Oil Seal	310649	1
18-2058	Oil Seal	313353	2
18-2060	Oil Seal	321467	2
18-3722	Locknut	121731	4
18-4248	Washer	311598	2
18-7101	O-Ring	305739	1
18-7102	O-Ring	307450	1
18-7120	O-Ring	307853, 322598	1
18-7127	O-Ring	313446	1
18-7130	O-Ring	314728	1
18-7178	O-Ring	320140	1
18-7404	O-Ring	909747	1
18-7475	Quad Ring	332583	4
18-7168	O-Ring	202893	1
18-7409	O-Ring	911871	2
18-2001	Oil Seal	330137	2
18-7479	O-Ring	—	1
18-3153	S.S. Bolt	908158	2



**18-2665**  
**LOWER UNIT**  
**SEAL KIT**  
 Replaces: 982946  
 V6,V8 (800) Stringer Unit (1978-86)

— CONTAINS —

Part #	Desc.	O.E. #	Qty.
18-0110	Shift Housing Gasket	324670	1
18-3133	Housing Screw	908158	2
18-0188	Washer	909748	1
18-2002	Oil Seal	320862	2
18-2020	Oil Seal	310649	1
18-2058	Oil Seal	313353	2
18-2060	Oil Seal	321467	2
18-2911	Swivel Bearing Housing Gasket	910236	1
18-3722	Locknut	121731	6
18-4248	Washer	311598	2
18-7101	O-Ring	305739	1
18-7102	O-Ring	307450	1
18-7120	O-Ring	307853, 322598	1
18-7130	O-Ring	314728	1
18-7142	O-Ring	322119	1
18-7178	O-Ring	320140	1
18-7403	O-Ring	909316	2
18-7404	O-Ring	909747	1
18-7475	Quad Ring	332583	4
18-7168	O-Ring	202893	1
18-7479	O-Ring	—	1
18-3153	S.S. Bolt	908158	2



**18-2666**  
**UPPER UNIT SEAL KIT**  
 Replaces: 981799  
 100-245 Stringer Unit (1968-72)

— CONTAINS —

Part #	Desc.	O.E. #	Qty.
18-0939	Upper Gearcase Gasket	315189	1
18-2073	Oil Seal	981268	4
18-3111	Rubber Seal	907774	1
18-4248	Washer	311598	2
18-7103	O-Ring	308624	4
18-7107	O-Ring	313175	1
18-7121	O-Ring	308621	1
18-7134	O-Ring	303059	1
18-7146	O-Ring	554545	1
18-7173	O-Ring	910582	1
18-7198	O-Ring	308626	2
18-7158	O-Ring	310585, 310967	1
18-7172	O-Ring	553126	1

— CONTAINS —

Part #	Desc.	O.E. #	Qty.
18-0939	Upper Gearcase Gasket	315189	1
18-2072	Oil Seal	981196	2
18-2073	Oil Seal	981268	2
18-3111	Rubber Seal	907774	1
18-3725	Locknut	908064	1
18-4248	Washer	311598	2
18-4251	Plug	908062	1
18-7107	O-Ring	313175	1
18-7114	O-Ring	302540	1
18-7121	O-Ring	308621	1
18-7129	O-Ring	314491	1
18-7477	Quad Ring	909048	1
18-7168	O-Ring	202893	1
18-7172	O-Ring	553126	1
18-7173	O-Ring	910582, 310327	1



**18-2667**  
**UPPER UNIT SEAL KIT**  
 Replaces: 982949  
 All Stringer Unit (1973-86)

— CONTAINS —

Part #	Desc.	O.E. #	Qty.
18-0917	Tilt Motor Gasket	311508	1
18-0923	Seal Gasket	313244	2
18-0939	Upper Gearcase Gasket	315189	1
18-0949	Trunion Cap Gasket	316499	2
18-2004	Oil Seal	—	1
18-2016	Oil Seal	313992	2
18-2066	Oil Seal	911019	1
18-2071	Oil Seal	981195	2
18-3725	Locknut	908064	1
18-4248	Washer	311598	1
18-4251	Plug	908062	1
18-7114	O-Ring	302540	1
18-7162	O-Ring	302337	1
18-7400	O-Ring	908194	1
18-7401	O-Ring	908383	1
18-7198	O-Ring	308626	2
18-2863	Tilt Clutch Cover Gasket	308799	1



**18-2669**  
**INTERMEDIATE HOUSING SEAL KIT**  
 Replaces: 981801  
 100-245 Stringer Unit (1973-77)

— CONTAINS —

Part #	Desc.	O.E. #	Qty.
18-2004	Oil Seal	—	1
18-2016	Oil Seal	313992	2
18-2060	Oil Seal	321467	2
18-2071	Oil Seal	981195	2
18-2863	Tilt Clutch Cover Gasket	308799	1
18-3725	Locknut	908064	1
18-4248	Washer	311598	3
18-4251	Plug	908062	1
18-7114	O-Ring	302540	1
18-7162	O-Ring	302337	1
18-7400	O-Ring	908194	1
18-7401	O-Ring	908383	1
18-7168	O-Ring	202893	3
18-7198	O-Ring	308626	2
18-0917	Tilt Motor Gasket	311508	1
18-0923	Seal	313244	2
18-0939	Upper Gearcase Dipstick Gasket	315189	1
18-0947	Pivot Cap Cover Gasket	909529	2
18-0913	Tilt Motor Gasket	909902	1

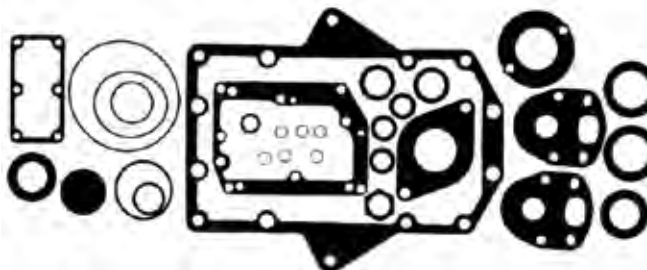

**18-2670**  
**INTERMEDIATE HOUSING SEAL KIT**  
 Replaces: 982948  
 All Stringer Unit (1978-86)

— CONTAINS —

Part #	Desc.	O.E. #	Qty.
18-0880	Shift Cover Gasket	911878	1
18-0166	Grommet	911705	2
18-0190	Wiper	912157	1
18-4248	Washer	311598	2
18-7127	O-Ring	313446	1
18-7130	O-Ring	314728	1
18-7137	O-Ring	318372	1
18-7138	O-Ring	318717	3
18-7145	O-Ring	333572	2
18-7475	Quad Ring	332584	5
18-2001	Oil Seal	330137	2



**18-2671**  
**LOWER UNIT SEAL KIT**  
 Replaces: 985612  
 All 4 cyl. Cobra (1986-89)





**18-2672**  
**LOWER UNIT SEAL KIT**  
 Replaces: 984458, 985613, 439967  
 All V6/V8 Cobra (1986-1991)

— CONTAINS —

Part #	Desc.	O.E. #	Qty.
18-0880	Shift Cover Gasket	911878	1
18-0166	Grommet	911705	2
18-0190	Wiper	912157	1
18-2002	Oil Seal	320862	2
18-4248	Washer	311598	2
18-7130	O-Ring	314728	1
18-7137	O-Ring	318372	1
18-7138	O-Ring	318717	3
18-7142	O-Ring	322119	1
18-7145	O-Ring	333572	2
18-7475	Quad Ring	332584	5
18-0440	Water Passage Gasket	915719	1



**18-2673**  
**UPPER UNIT SEAL KIT**  
 Replaces: 984459, 986364, 987603  
 All Cobra (1986-89)

— CONTAINS —

Part #	Desc.	O.E. #	Qty.
18-0911	Water Pump Base Gasket	911698	1
18-0884	Water Cover Gasket	911733	1
18-0166	Grommet	911705	2
18-2067	Oil Seal	911685	1
18-2068	Oil Seal	911701, 916058, 915000	1
18-2541	Rubber Seal	911704	1
18-2916	Water Pump Housing Gasket	911702	1
18-2918	Outdrive Gasket	915840	1
18-2996	Seal	911823	1
18-7107	O-Ring	313175	1
18-7116	O-Ring	303067	1
18-7138	O-Ring	318717	2
18-7153	O-Ring	—	2
18-7169	O-Ring	911686	1
18-7403	O-Ring	909316	1
18-7407	O-Ring	911700	1



**18-2674**  
**TRANSOM MOUNT SEAL KIT**  
 Replaces: 985518, 986423  
 All Cobra (1986-89)

— CONTAINS —

Part #	Desc.	O.E. #	Qty.
18-2070	Oil Seal	911795	1
18-2138	Bearing	911787	3
18-2139	Bearing	911794	1
18-2533	Foam Seal	911797	1
18-2918	Outdrive Gasket	915840, 911836	1
18-2996	Seal	911823	1
18-4250	Washer	911820	2
18-7141	O-Ring	321117	12
18-7143	O-Ring	322501	1
18-7162	O-Ring	302337	1
18-7165	O-Ring	304174	1
18-7406	O-Ring	911311	3
18-7408	O-Ring	911718	2
18-7409	O-Ring	911871	1
18-7168	O-Ring	202893	1



**18-2783**  
**LOWER UNIT SEAL KIT**  
 Replaces: 986629  
 King Cobra Lower Unit - 1990



**18-2791**  
**GEARCASE SEAL KIT**  
 Replaces: 987251, 3850597  
 Fits: 3.0L, 4.3L, 5.0L (1994), 3.2L (1992-93),  
 5.7L (1992-94), 7.4L (1992-95), 8.2L (1992-93)

### SEAL KIT APPLICATION

Model	Year	Lower Gearcase Seal Kit	Upper Gearcase Seal Kit	Intermediate Housing Seal Kit	Transom Mount Seal Kit	Model	Year	Lower Gearcase Seal Kit	Upper Gearcase Seal Kit	Intermediate Housing Seal Kit	Transom Mount Seal Kit
2.3	1987-90	18-2671	18-2673	N/A	18-2674	165	1972	18-2663	18-2666	18-2668	N/A
2.5 ①	1982-86	18-2664	18-2667	18-2670	N/A	165	1973-76	18-2663	18-2667	18-2669	N/A
2.5 ②	1986	18-2671	18-2673	N/A	18-2674	170	1974	18-2663	18-2667	18-2669	N/A
3 ①	1982-86	18-2664	18-2667	18-2670	N/A	175	1975-77	18-2663	18-2667	18-2669	N/A
3 ②	1986-91	18-2671	18-2667	18-2670	N/A	185	1968	18-2663	18-2666	18-2668	N/A
4.3 ①	1985-86	18-2665	18-2667	18-2670	N/A	185	1978-80	18-2665	18-2667	18-2670	N/A
4.3 ②	1986-91	18-2672	18-2673	N/A	18-2674	190	1974-77	18-2663	18-2667	18-2669	N/A
3.8	1981-86	18-2665	18-2667	18-2670	N/A	200	1968	18-2663	18-2666	18-2668	N/A
5 ①	1982-86	18-2665	18-2667	18-2670	N/A	200	1979-81	18-2665	18-2667	18-2670	N/A
5 ②	1986-91	18-2672	18-2673	N/A	18-2674	210	1968-70	18-2663	18-2666	18-2668	N/A
5.7 ①	1982-86	18-2665	18-2667	18-2670	N/A	215	1971	18-2663	18-2666	18-2668	N/A
5.7 ②	1986-89	18-2672	18-2673	N/A	18-2674	225	1972	18-2663	18-2666	18-2668	N/A
5.7 ③	1990-91	18-2672	18-2673	N/A	18-2674	225	1973-76	18-2663	18-2667	18-2669	N/A
5.8	1989-90	18-2672	18-2673	N/A	18-2674	225	1978	18-2665	18-2667	18-2670	N/A
7.5	1987	—	18-2673	N/A	18-2674	230	1979-81	18-2665	18-2667	18-2670	N/A
80	1969	18-2663	18-2666	18-2668	N/A	235	1971	18-2663	18-2666	18-2668	N/A
90	1970	18-2663	18-2666	18-2668	N/A	235	1975-77	18-2663	18-2667	18-2669	N/A
100	1972	18-2663	18-2666	18-2668	N/A	240	1978	18-2665	18-2667	18-2670	N/A
100	1973	18-2663	18-2667	18-2669	N/A	245	1972	18-2663	18-2666	18-2668	N/A
120	1968-72	18-2663	18-2666	18-2668	N/A	245	1973-75	18-2663	18-2667	18-2669	N/A
120	1973-77	18-2663	18-2667	18-2669	N/A	250	1979	18-2665	18-2667	18-2670	N/A
120	1978-81	18-2664	18-2667	18-2670	N/A	260	1979-81	18-2665	18-2667	18-2670	N/A
140	1973-77	18-2663	18-2667	18-2669	N/A	262	1989	18-2672	18-2673	N/A	18-2674
140	1978-81	18-2664	18-2667	18-2670	N/A	350	1988-89	18-2672	18-2673	N/A	18-2674
155	1968-72	18-2663	18-2666	18-2668	N/A	460	1988-89	—	18-2673	N/A	18-2674

① Except Cobra    ② Cobra    ③ Except L.E.    N/A Not Applicable

### OIL SEALS



Part #	O.E. #	Shaft Size	Dimensions (in)		Part #	O.E. #	Shaft Size	Dimensions (in)	
			O.D.	Width				O.D.	Width
18-0542	321831	0.750	1.253	0.186	18-2034	324639	0.437	0.937	0.188
18-0543	321895	1.540	1.926	0.243	18-2035	327031	0.425	0.875	0.313
18-0559	332585	0.285	0.357	0.940	18-2058	313353	1.938	2.438	0.250
18-2000	309989	1.375	2.000	0.313	18-2059	321466	0.750	1.126	0.200
18-2001	330137	1.125	1.624	0.250	18-2060	321467	1.000	1.375	0.250
18-2002	320862	1.188	1.692	0.250	18-2061	329922	0.822	1.375	0.195
18-2005	313284	0.625	1.128	0.250	18-2062	329923	0.875	1.375	0.207
18-2012	310599	1.000	1.499	0.250	18-2063	330327	0.625	1.124	0.188
18-2016	313992	1.187	1.875	0.250	18-2064	332205	0.730	1.130	0.194
18-2018	305987	1.000	1.375	0.250	18-2065	332261	0.625	1.375	0.195
18-2020	310649	2.500	3.000	0.250	18-2066	911019	1.000	1.375	0.435
18-2021	302564	0.750	1.375	0.250	18-2067	911685	2.000	2.509	0.315
18-2022	303345	0.554	1.000	0.375	18-2068	911701	0.500	0.905	0.250
18-2023	313282	0.554	1.062	0.312	18-2068	915702	0.500	0.905	0.250
18-2024	314167	0.425	0.937	0.312	18-2068	916058	0.500	0.905	0.250
18-2025	318972	0.500	0.875	0.250	18-2068	3853655	0.500	0.905	0.200
18-2026	321453	0.875	1.250	0.188	18-2071	981195	1.500	2.125	0.250
18-2027	321459	0.625	1.125	0.250	18-2072	981196	1.750	2.502	0.250
18-2028	321480	0.500	1.250	0.188	18-2073	981268	1.625	2.502	0.250
18-2029	321481	0.687	1.250	0.250	18-2074	322575	1.625	2.125	0.250
18-2030	321786	0.625	1.125	0.188	18-2074	339620	1.625	2.125	0.250
18-2031	321787	0.625	1.125	0.312	18-2075	332942	1.562	2.062	0.300
18-2032	321788	0.500	1.000	0.188	18-8349	911795,	1.375	2.186	0.500
18-2033	321928	0.625	1.375	0.250		3852548			

UPPER GEARCASE (Cobra)				
ENGINE	YEAR	OIL SEAL	DESC.	QTY
262 - 460	1988-89	18-2067	BC	1
262 - 460	1988-90	18-2068	WPS	1
2.3 - 7.5	1986-90	18-2068	WPS	1
2.3 - 7.5	① 1986-90	18-2067	BC	1

① 5.7 '90 574 AMPWS, ARPWS  
**BC** Bearing Carrier Seal  
**WPS** Water Pump Seal

LOWER GEARCASE (Stringer)				
ENGINE	YEAR	OIL SEAL	DESC.	QTY
80/90	1968-71	18-2066	BR,L	2
80/90	1968-71	18-2066	PS	2
88/90	1964-68	18-2012	BR	1
80 - 260	1968-81	18-2020	BR,U	1
80 - 260	1968-81	18-2058	BR,M	2
110 - 200	① 1964-67	18-2012	BR	2
110 - 245	① 1964-77	18-2012	PS	2
110/120	② 1964-67	18-2012	BR	1
120 - 245	1968-77	18-2012	BR,L	2
120 - 260	1978-81	18-2060	BR,L	2
120/140	1978-81	18-2001	PS	2
155	③ 1967	18-2058	BR,M	2
155	③ 1967	18-2020	BR,U	1
185 - 260	1978-81	18-2002	PS	2
210 - 260	④ 1972-75	18-2066	IH	1
230/260	④ 1976	18-2060	IH	1
305/350/454	④ 1977-78	18-2060	IH	1
2.5/3.0	1982-86	18-2001	PS	2
2.5 - 5.7	1981-86	18-2020	BR,U	1
2.5 - 5.7	1981-86	18-2058	BR,M	2
2.5 - 5.7	1981-86	18-2060	BR,L	2
3.8 - 5.7	1981-86	18-2002	PS	2

① 110, 120 HP '64-67 Hvy. Duty Dr.  
 ② Standard Drive  
 ③ HU, HUE 16 C Models  
 ④ Inboard  
**BR** Driveshaft Bearing Retainer Seal  
**BR,U** Driveshaft Bearing Retainer Upper Seal  
**BR,M** Driveshaft Bearing Retainer Middle Seal  
**BR,L** Driveshaft Bearing Retainer Lower Seal  
**IH** Impeller Housing Seal  
**PS** Prop Shaft Seal

UPPER GEARCASE (Stringer)				
ENGINE	YEAR	OIL SEAL	DESC.	QTY
80 - 245	1968-72	18-2073	BGS	1
80 - 260	1969-81	18-2073	IH	2
88 - 200	1964-66	18-2000	BGS	1
90	③ 1967	18-2000	BGS	1
90	④ 1967	18-2073	BGS	1
100 - 245	1972-73	18-2073	BGS	1
100 - 260	1973-81	18-2072	BGS	2
120	① 1967	18-2073	BGS	1
120	② 1967	18-2000	BGS	1
120	① 1967	18-2073	IH	2
120 - 210	1968	18-2073	IH	2
155	1967	18-2073	IH	2
155	⑤ 1967	18-2000	BGS	1
155	1967	18-2073	BGS	1
185	1967	18-2000	BGS	1
200	⑥ 1967	18-2000	BGS	1
200	⑦ 1967	18-2073	IH	2
200	⑦ 1967	18-2073	BGS	1
2.5 - 5.7	1981-86	18-2072	BGS	2
2.5 - 5.7	1981-86	18-2073	IH	2

① CU, CUE 16C Models  
 ② CU15S Models  
 ③ DU, DUE 14D Models  
 ④ DU, DUE 15S Models  
 ⑤ HU, HUE 15S Models  
 ⑥ TU, TUE 15S Models  
 ⑦ TU, TUE 16C Models  
**BGS** Ball Gear Shaft Seal  
**IH** Impeller Housing Seal

LOWER GEARCASE (Cobra)				
ENGINE	YEAR	OIL SEAL	DESC.	QTY
262 - 460	1988-89	18-2002	PS	2
2.3	1990	18-2001	PS	2
2.3 - 3.0	1986-89	18-2001	PS	2
3	1990	18-2002	PS	2
4.3 - 7.5	1986-90	18-2002	PS	2

**PS** Prop Shaft Seal

INTERMEDIATE HOUSING (Stringer)				
ENGINE	YEAR	OIL SEAL	DESC.	QTY
80 - 235	1964-71	18-2000	BG,O	1
80 - 245	1964-72	18-2001	BG,I	1
80 - 260	② 1964-80	18-2066	CL	1
100 - 245	1972	18-2000	BG,O	2
100 - 260	1973-79	18-2016	BG,I	1
100 - 260	1973-81	18-2071	BG,O	2
120 - 260	1980-81	18-2016	BG,I	2
120 - 260	① 1980-81	18-2060	CL	2
2.5 - 5.7	1981-86	18-2060	CL	2
2.5 - 5.7	1981-86	18-2016	BG,I	2
2.5 - 5.7	1981-86	18-2071	BG,O	2

**CL** Clutch  
 ① 120, 140 '80C Models/185—260 '80 K&U Models  
 ② C Models in '80  
**BG,I** Driveshaft Ball Gear Inner Seal  
**BG,O** Driveshaft Ball Gear Outer Seal



O-RINGS

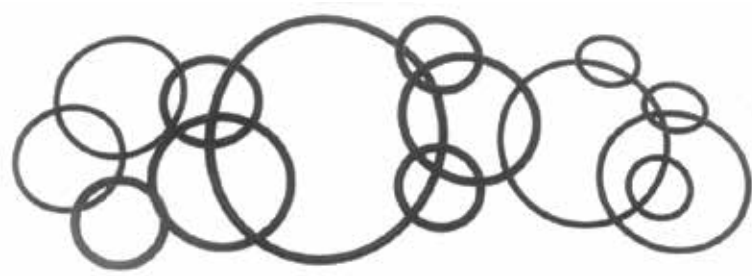

Part #	O.E. #	Dimensions (in)		Part #	O.E. #	Dimensions (in)	
		I.D.	Width			I.D.	Width
18-7100	② ⑤ 301877	.245	.155	18-7150	③ ⑤ 331380	.225	.115
18-7101	② ⑤ 305739	.250	.065	18-7150	③ ⑤ 334913	.225	.115
18-7102	② ⑤ 307450	.430	.065	18-7152	② ⑤ 307082	2.625	.135
18-7103	② ⑤ 308624	.920	.100	18-7153	① 3852565,		
18-7104	② ⑤ 308627	2.210	.135		911851	.0860	.100
18-7105	② ⑤ 311338	.750	.065	18-7155	② ⑤ 305270	1.620	.135
18-7107	② ⑤ 313175	4.750	.135	18-7156	② ⑤ 309731	1.185	.100
18-7108	② ⑤ 313893	2.550	.100	18-7158	② ⑤ 310585	.740	.100
18-7108	② ⑤ 338518	2.550	.100	18-7162	② ⑤ 302337	2.025	.135
18-7109	② ⑤ 317178	.214	.048	18-7164	② ⑤ 302537	1.375	.100
18-7111	① 301824	.197	.113	18-7165	② ⑤ 304174	.500	.065
18-7112	① 302493	1.170	.135	18-7167	② ⑤ 310414	3.625	.135
18-7114	② ⑤ 302540	1.000	.135	18-7168	② ⑤ 202893	.370	.065
18-7115	① 302588	1.735	.135	18-7169	② ⑤ 911686	3.500	.135
18-7116	① 303067	.360	.100	18-7170	① 307239	1.365	.135
18-7117	① 303360	1.060	.135	18-7172	② ⑤ 553126	3.250	.135
18-7118	② ⑤ 305242	.300	.135	18-7173	② ⑤ 310327	1.875	.135
18-7120	① 307853	.215	.065	18-7174	② ⑤ 326649	.620	.100
18-7120	① 332598	.215	.065	18-7178	② ⑤ 320140	.920	.135
18-7121	① 308621	3.100	.135	18-7180	② ⑤ 303347	.445	.090
18-7123	① 308876	2.235	.100	18-7198	② ⑤ 308626	1.430	.100
18-7126	① 313340	1.690	.100	18-7400	② ⑤ 908194	4.000	.100
18-7127	① 313446	3.315	.135	18-7401	② ⑤ 908383	2.485	.100
18-7128	① 313754	1.835	.100	18-7403	② ⑤ 909316	1.500	.100
18-7129	② ⑤ 314491	.970	.065	18-7404	② ⑤ 909747	.300	.100
18-7130	① 314728	2.125	.100	18-7406	② ⑤ 911311	0.250	.065
18-7133	② ⑤ 305123	3.780	.135	18-7407	② ⑤ 911700	4.125	.135
18-7134	② ⑤ 303059	.500	.100	18-7407	② ⑤ 3852531	4.125	.135
18-7135	① 310584	.750	.135	18-7408	② ⑤ 911718	1.060	.100
18-7137	② ⑤ 318372	0.320	.155	18-7409	② ⑤ 911871	1.175	.100
18-7138	② ⑤ 318717	1.500	.210	18-7413	② ⑤ 303191	.301	.070
18-7139	② ⑤ 319085	1.080	.210	18-7416	② ⑤ 329380	.612	.103
18-7140	② ⑤ 320303	2.750	.135	18-7417	② ⑤ 329381	.362	.103
18-7141	② ⑤ 321117	.180	.065	18-7418	② ⑤ 326741	4.484	.139
18-7142	② ⑤ 322119	3.940	.135	18-7440-1	④ 301967	.799	.103
18-7143	② ⑤ 322501, 331188	1.310	.100	18-7457	① 319662	1.799	.103
18-7144	② ⑤ 326849	4.250	.135	18-7461	① 308458	1.612	.103
18-7145	② ⑤ 333572	.250	.100	18-7475	② ⑤ 332584	.250	.065
18-7146	② ⑤ 554545	1.120	.100	18-7477	② ⑤ 909048	.480	.100
18-7150	③ ⑤ 303598	.225	.115	18-7510	① 321163	2.750	.070

① Pkg. of 1      ② Pkg. of 5      ③ Pkg. of 10      ④ Indicates Quad Rings rather than O-Rings

TRANSOM MOUNT (Cobra)					TRANSOM MOUNT (Cobra) (Cont.)				
ENGINE	YEAR	O-RING	DESC.	QTY.	ENGINE	YEAR	O-RING	DESC.	QTY.
262 - 460	1988-89	18-7165	SCS	1	2.3 - 7.5	① 1986-90	18-7165	SCS	1
262 - 460	1988-89	18-7408	NP	2	2.3 - 7.5	① 1986-90	18-7409	SC	1
262 - 460	1988-89	18-7409	SC	1	2.3 - 7.5	1986-90	18-7143	MB	1
262 - 460	1988-89	18-7406	PL	1					
262 - 460	1988-89	18-7168	BC	1					
262 - 460	1988-90	18-7162	UG	1					
262 - 460	1988-90	18-7143	MB	1					
2.3 - 7.5	① 1986-90	18-7168	BC	1					
2.3 - 7.5	1986-90	18-7162	UG	1					
2.3 - 7.5	① 1986-90	18-7406	PL	1					
2.3 - 7.5	① 1986-90	18-7408	NP	2					

① 5.7 '90 574 AMPWS, ARPWS  
**BC** Bell Crank Seal  
**MB** Manifold Block Seal  
**UG** Upper Gimbal Seal  
**SCS** Shift Cable Seal  
**PL** Plug Seal  
**NP** Nipple Seal  
**SC** Sleeve and Connector Seal

⑤ This product is priced per piece. To order priced per package, please add -9 to the part number.

UPPER GEARCASE (Cobra)					POWER TILT AND TRIM (Cobra)				
ENGINE	YEAR	O-RING	DESC.	QTY	ENGINE	YEAR	O-RING	DESC.	QTY
262 - 460	1988-89	18-7403	A,S	1	262 - 460	1988-90	18-7141	OL	12
262 - 460	1988-89	18-7107	GHC	1	262 - 460	1988-90	18-7102	PL	1
262 - 460	1988-89	18-7407	A,L	1	350 - 460	1988	18-7174	VSH	1
262 - 460	1988-90	18-7169	BC	1	350 - 460	1988	18-7168	VS	4
350 - 460	1990	18-7116	OFF	1	350 - 460	1988	18-7174	VA,L	2
350 - 460	1990	18-7407	BC	1	350 - 460	1988	18-7165	VA,S	2
350 - 460	1990	18-7406	WDP	1	2.3 - 7.5	1986-88	18-7174	VSH	1
370	1988	18-7407	AB	1	2.3 - 7.5	1986-88	18-7168	VS	4
460	1990	18-7407	BC	1	2.3 - 7.5	1986-88	18-7174	VA,L	2
2.3 - 5.8	1990	18-7116	OFF	1	2.3 - 7.5	1986-88	18-7165	VA,S	2
2.3 - 7.5	① 1986-90	18-7107	GHC	1	2.3-7.5	1986-90	18-7102	PL	1
2.3 - 7.5	① 1986-90	18-7407	A,L	1	2.3-7.5	1986-90	18-7141	OL	12
2.3 - 7.5	1986-90	18-7169	BC	1					
2.3 - 7.5	① 1986-90	18-7403	A,S	1					
5.7	② 1990	18-7406	WDP	1					
5.7	② 1990	18-7407	BC	1					
① 5.7 '90 574 AMPWS, ARPWS ② 574 PEPWS <b>GHC</b> Gear Hsg. Cover Seal <b>OFF</b> Oil Fill Plug Seal <b>BC</b> Bearing Carrier Seal <b>A,S</b> Adaptor, Small Seal <b>A,L</b> Adaptor, Large Seal <b>WDP</b> Water Drain Plug Seal <b>AB</b> Anchor Block Seal					<b>PL</b> Plug Seal <b>VS</b> Valve Seat Assy. Seal <b>VA,L</b> Valve Assy., Large Seal <b>VA,S</b> Valve Assy., Small Seal <b>VSH</b> Valve Seat Hsg. Seal <b>OL</b> Oil Line Seal				
LOWER GEARCASE (Cobra)					OIL AND COOLING SYSTEM (Cobra)				
ENGINE	YEAR	O-RING	DESC.	QTY	ENGINE	YEAR	O-RING	DESC.	QTY
262/350	1988-89	18-7475	PBHS	4	262/454	1989-90	18-7135	AR	1
262/350	1988-89	18-7142	PBH	1	262 - 460	1988-90	18-7116	ODF	1
262 - 460	1988-89	18-7130	DS B	1	350/460	1988-90	18-7135	AR	1
262 - 460	1988-89	18-7475	BSS	1	370	1988	18-7162	THERM	1
262 - 460	1988-89	18-7138	DS BH	3	2.3 - 5.8	1988-90	18-7116	ODF	1
262 - 460	1988-89	18-7137	SR	1	4.3	① 1990	18-7135	AR	1
350 - 460	1990	18-7145	PL	1	7.5	1987	18-7135	AR	1
370	1988	18-7130	SL	2					
370/460	1988-89	18-7145	D&F S	2					
2.3	1987	18-7145	D&F S	2					
2.3	1990	18-7127	PBH	1					
2.3 - 3.0	1986-89	18-7127	PBH	1					
2.3/3.0	1988-90	18-7145	D&F S	2					
2.5 - 5.7	1986	18-7145	D&F S	2					
2.3 - 5.8	① 1986-90	18-7475	PBHS	4					
2.3 - 7.5	① 1986-90	18-7475	BSS	1					
2.3 - 7.5	① 1986-90	18-7138	DS BH	3					
2.3 - 7.5	① 1986-90	18-7137	SR	1					
2.3 - 7.5	① 1986-90	18-7130	DS B	1					
3.0 - 5.8	① 1990	18-7142	PBH	1					
4.3 - 5.8	1989-89	18-7142	PBH	1					
5.7	② 1990	18-7145	PLUG	1					
① 5.7 '90 574 AMPWS, ARPWS ② 574 PEPWS <b>BSS</b> Bearing Setscrew Seal <b>DS BH</b> Driveshaft Bearing Hsg. Seal <b>DS B</b> Driveshaft Bearing Seal <b>D&amp;F S</b> Drain & Fill Screw Seal <b>PBH</b> Prop Bearing Hsg. Seal <b>PBHS</b> Prop Bearing Hsg. Screw Seal <b>PL</b> Plug Seal <b>SR</b> Shift Rod Seal <b>SL</b> Sleeve Seal					① V-4 Only <b>ODF</b> Oil Drain Fitting Seal <b>AR</b> Adapter Retainer Seal <b>THERM</b> Thermostat Seal				
POWERHEAD (Stringer)					INTERMEDIATE HOUSING (Stringer)				
ENGINE	YEAR	O-RING	DESC.	QTY	ENGINE	YEAR	O-RING	DESC.	QTY
80/90	1969-71	18-7108	WP	1	80	1968	18-7162	SL	1
88	1964	18-7133	CCH	3	80 - 90	1964-68	18-7174	WT	1
88/90	1964-68	18-7120	CCHS	4	80 - 210	1964-70	18-7123	BGR	1
90	1965-68	18-7133	CCH	4	80 - 245	① 1964-72	18-7174	PS	1
120/140	1977-80	18-7114	CP	1	80 - 260	1964-81	18-7198	COV	2
120 - 235	1976	18-7114	CP	1	80 - 260	1964-81	18-7114	WR	1
					80 - 260	1969-81	18-7162	SL	1
					88	1964	18-7104	TH	1
					88	1964	18-7174	TC	1

**INTERMEDIATE HOUSING (Stringer) (Cont.)**

ENGINE	YEAR	O-RING	DESC.	QTY
90 - 235	1970-71	18-7158	DS	1
90 - 235	② 1971	18-7123	BGR	1
100 - 260	1973-81	18-7401	BGR	1
100 - 260	1973-81	18-7400	TUC	1
120	③ 1967	18-7162	SL	1
120 - 210	1968	18-7162	SL	1
120/140	1981	18-7168	FS	3
155	④ 1967	18-7162	SL	1
2.5 - 5.7	1981-86	18-7400	TUC	1
2.5 - 5.7	1981-86	18-7198	COV	2
2.5 - 5.7	1981-86	18-7114	WR	1
2.5 - 5.7	1981-86	18-7401	BGR	1
2.5 - 5.7	1981-86	18-7162	SL	1
2.5 - 5.7	1982	18-7168	FS	3

- ① Rope or Pull-Pull Steering Models
- ② All 90/120, 155, 210 EX Models/235 XUFM20S prior to S/N 202880 and 235 XUFM20S prior to S/N 204600
- ③ CU, CUE 16C
- ④ 120, 155, 215, 20D Models/235 XUFR20S S/N 202880 & up and 235 XUFM20S S/N 204600 & up 235 20D all Models
- COV** Pivot Cap Cover Seal
- BGR** Ball Gear Retainer Seal
- DS** Driveshaft to Hsg. Seal
- TC** Driveshaft Tube Cover Seal
- TH** Driveshaft Tube to Hsg.
- FS** Fill Screw Seal
- PS** Pulley Shaft
- SL** Sleeve to Hsg. Seal
- TUC** Tilt Unit Cover Seal
- WT** Water Tube Seal
- WR** Worm Gear Retainer Seal

**UPPER GEARCASE (Stringer)**

ENGINE	YEAR	O-RING	DESC.	QTY
80 - 90	1968-71	18-7158	BG	1
80 - 90	1964-68	18-7174	IH	1
80 - 245	① 1964-72	18-7103	WG	1
80 - 245	① 1964-74	18-7134	G	1
80 - 260	1964-81	18-7172	IH	1
80 - 260	1964-81	18-7121	BGR	1
80 - 260	1968-80	18-7173	WW	1
80 - 260	② 1968-81	18-7107	WW	1
90	③ 1967	18-7107	WW	1
90 - 200	1964-67	18-7128	CAP	1
90 - 200	1965-67	18-7173	WW	2
90 - 245	④ 1967-72	18-7146	BG	1
100 - 245	1973-75	18-7114	WS	1
100 - 260	1973-81	18-7129	DS IH	1
110 - 120	⑤ 1964-67	18-7158	IH	1
110 - 120	⑥ 1964-67	18-7174	IH	1
120 - 200	⑦ 1967	18-7107	WW	1
120 - 235	1968-71	18-7158	IH	1
120 - 260	1975-81	18-7477	G	1
150 - 210	1964-67	18-7158	IH	1
2.5/3.0	1982	18-7168	OP	1
2.5 - 5.7	1981-86	18-7477	G	1
2.5 - 5.7	1981-86	18-7172	IH	1
2.5 - 5.7	1981-86	18-7107	WW	1
2.5 - 5.7	1981-86	18-7121	BGR	1
2.5 - 5.7	1981-86	18-7129	DS IH	1

**UPPER GEARCASE (Stringer) (Cont.)**









- ① Rope or Pull-Pull Steering Models
- ② 155 HP 1968 HU, HUE 16C
- ③ DU, DUE 15S
- ④ 90 HP '67 DU, DUE 15S/120 and 200 '67 16C Models
- ⑤ Heavy Duty Drive
- ⑥ Standard Gearcase
- ⑦ 16C Models
- BG** Ball Gear Seal
- BGR** Ball Gear Retainer Seal
- DS IH** Driveshaft Impeller Hsg. Seal
- IH** Impeller Hsg. Seal
- CAP** Gear Hsg. Cap Seal
- OP** Oil Plug Seal
- WR** Steering Worm Wheel Retainer Seal
- WS** Steering Worm Wheel Spacer Seal
- WG** Steering Worm Wheel Gear Seal
- WW** Steering Worm Wheel Seal
- G** Gear Seal

**LOWER GEARCASE (Stringer)**

ENGINE	YEAR	O-RING	DESC.	QTY
80 - 90	1964-69	18-7120	PBH S	4
80 - 90	1964-71	18-7152	PBH	1
80 - 90	1964-71	18-7115	BR	1
80 - 90	1964-71	18-7174	DS	1
88/90	1964-68	18-7173	DSB	2
90 - 245	1970-77	18-7120	PBH S	4
100 - 245	1968-72	18-7135	BR	1
100 - 245	1969-77	18-7167	PBH	1
110/120	② 1964-67	18-7167	PBH	1
110/120	① 1964-67	18-7174	DS	1
110/120	② 1964-67	18-7135	BR	1
110/120	① 1964-67	18-7152	PBH	1
110/120	① 1964-67	18-7173	DSB	2
110/120	① 1964-67	18-7115	BR	1
120	① 1964-67	18-7120	PBH S	4
120/140	1978-81	18-7127	PBH	1
120/140	1978	18-7156	SA,L	2
120 - 235	1977	18-7129	DS	1
120 - 240	1978	18-7178	SA,S	1
120 - 260	1978-81	18-7130	BR	1
120 - 260	1978-81	18-7102	PIN	1
120 - 260	1978-81	18-7109	PBH S	4
120 - 260	1978-81	18-7404	PIN	1
120 - 260	1979-81	18-7120	BSS	1
120 - 260	1981	18-7168	D&F S	1
150 - 200	1964-67	18-7135	BR	1
150 - 210	1964-68	18-7167	PBH	1
185 - 240	1978	18-7403	SA,L	2
185 - 260	1978-81	18-7142	PBH	1
2.5 - 5.7	1981-82	18-7168	D&F S	1
2.5 - 5.7	1981-83	18-7109	PBH S	4
2.5 - 5.7	1981-86	18-7130	BR	1
2.5 - 5.7	1981-86	18-7102	PIN	1
2.5 - 5.7	1981-86	18-7404	PIN	1
2.5 - 5.7	1981-86	18-7120	BSS	1
2.5 - 5.7	1981-86	18-7142	PBH	1
2.5/3.0	1982-86	18-7127	PBH	1
3.8	1981	18-7101	OSV	1

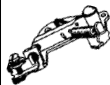
- ① Standard Drive
- ② Heavy Duty Drive
- OSV** Oil Stem Valve Seal
- PIN** Pinion Shaft Seal
- BR** Driveshaft Bearing Retainer Seal
- DS** Driveshaft Seal
- PBH** Prop Bearing Hsg. Seal
- DSB** Driveshaft Bushing Seal
- PBH S** Prop Bearing Hsg. Screw Seal
- D&F S** Drain & Fill Screw Seal
- SA,L** Shift Assy., Large Seal
- SA,S** Shift Assy., Small Seal
- BSS** Bearing Set Screw Seal

TUNE-UP APPLICATION FOR GAS ENGINE MODELS









									
Model Application	Oil Filter	Fuel Filter	Impeller	Drive Belt	Contact Set	Condenser	Rotor	Distributor Cap	Tune-Up Kit
MB 10 A	18-7878	—	18-3080	—	18-5305	—	18-5428	—	—
BB 30	18-7878	—	18-3080	—	18-5306	—	—	18-5357	—
BB 100	18-7878	—	18-3080	—	18-5306	—	—	18-5357	—
MB 18	18-7878	—	18-3080	—	18-5306	—	—	18-5357	—
AQ 60 F	18-7878	—	18-3080	—	18-5306	—	—	18-5357	—
MB 18 F	18-7878	—	18-3080	—	18-5306	—	—	18-5357	—
AQ 90	18-7878	—	18-3080	—	18-5306	—	—	18-5357	—
AQ 95	18-7878	—	18-3080	—	18-5306	—	—	18-5357	—
AQ 100	18-7878	—	18-3080	—	18-5306	—	—	18-5357	—
AQ 95A	18-7878	—	18-3080	—	18-5306	—	18-5428	18-5357	18-5257
AQ 110	18-7878	—	18-3080	—	18-5306	—	18-5428	18-5357	18-5257
AQ 120	18-7878	—	18-3080	—	18-5306	—	—	18-5357	—
BB 115 A	18-7878	—	18-3080	—	18-5305	—	18-5428	18-5356	—
BB 115 B	18-7878	—	18-3080	—	18-5305	—	18-5428	18-5356	—
BB 115 C	18-7878	—	18-3080	—	18-5305	—	18-5428	18-5356	—
MB 20 A	18-7878	—	18-3080	—	18-5305	—	18-5428	18-5356	—
MB 20 B	18-7878	—	18-3080	—	18-5306 ⑥ 18-5305 ⑦	—	18-5428 ⑥ ⑦	18-5356 ⑦	—
MB 20 C	18-7878	—	18-3080	—	18-5306 ⑥ 18-5305 ⑦	—	18-5428 ⑥ ⑦	18-5356 ⑦	—
AQ 115 A	18-7878	—	18-3080	—	18-5305	—	18-5428	18-5356 ④ 18-5357 ⑤	—
AQ 115 B	18-7878	—	18-3080	—	18-5305	—	18-5428	18-5356 ④ 18-5357 ⑤	—
AQ 130 A	18-7878	—	18-3080	—	18-5305	—	18-5428	18-5356 ④ 18-5357 ⑤	—
AQ 130 B	18-7878	—	18-3080	—	18-5305	—	18-5428	18-5356 ④ 18-5357 ⑤	—
AQ 130 C	18-7878	—	18-3080	—	18-5305	—	18-5428	18-5356 ④ 18-5357 ⑤	—
AQ 130 D	18-7878	—	18-3080	—	18-5305	—	18-5428	18-5356 ④ 18-5357 ⑤	—
BB 165 A	18-7878	—	18-3075	18-4044	18-5305 ⑨ 18-5319 ⑩	—	18-5428 ⑧ ⑨ 18-5424 ⑩	18-5393 ⑧ ⑨ 18-5394 ⑩	—
BB 170 A	18-7878	—	18-3075	18-4044	18-5305 ⑨ 18-5319 ⑩	—	18-5428 ⑧ ⑨ ⑩	18-5393 ⑧ ⑨ 18-5394 ⑩	—
BB 170 B	18-7878	—	18-3075	18-4044	18-5305 ⑨ 18-5319 ⑩	—	18-5428 ⑧ ⑨ ⑩	18-5393 ⑧ ⑨ 18-5394 ⑩	—
BB 170 C	18-7878	—	18-3075	18-4044	18-5305 ⑨ 18-5319 ⑩	—	18-5428 ⑧ ⑨ ⑩	18-5393 ⑧ ⑨ 18-5394 ⑩	—
AQ 165 A	18-7878	—	18-3075	18-4044	18-5305 ⑨ 18-5319 ⑩	18-5342 ⑧ ⑨	18-5428 ⑧ ⑨ ⑩	18-5393 ⑧ ⑨ 18-5394 ⑩	—
AQ 170 A	18-7878	—	18-3075	18-4044	18-5305 ⑨ 18-5319 ⑩	18-5342 ⑧ ⑨	18-5428 ⑧ ⑨ ⑩	—	—
AQ 170 B	18-7878	—	18-3075	18-4044	18-5305 ⑨ 18-5319 ⑩	18-5342 ⑧ ⑨	18-5428 ⑧ ⑨ ⑩	—	—
AQ 170 C	18-7878	—	18-3075	18-4044	18-5305 ⑨ 18-5319 ⑩	18-5342 ⑧ ⑨	18-5428 ⑧ ⑨	—	—
AQ 120 B	18-7878	18-7862 18-7858	18-3075	18-4044	18-5305	18-5349 ① 18-5348 ②	18-5428	18-5358 18-5356 ②	18-5284 ①
AQ 125 A	18-7878	18-7862 18-7858	18-3075	18-4044	18-5305	—	18-5428	—	—
AQ 125 B	18-7878	18-7862 18-7858	18-3075	18-15435	18-5305	—	18-5428	—	—
AQ 131 A	18-7878	18-7862 18-7858	18-3075	18-15435	18-5305	—	18-5428	—	—
AQ 131 B	18-7878	18-7862 18-7858	18-3075	18-15435	18-5305	—	18-5428	—	—
AQ 131 C	18-7878	18-7862 18-7858	18-3075	18-15435	18-5305	—	18-5428	—	—
AQ 131 D	18-7878	18-7862 18-7858	18-3075	18-15435	18-5305	—	18-5428	—	—
230A	18-7878	18-7862 18-7858	18-3075	18-15435	18-5305	—	18-5428	—	—
230B	18-7878	18-7862 18-7858	18-3075	18-4044	18-5305	—	18-5428	—	—
BB 140 A	18-7878	18-7862 18-7858	18-3075	18-4044	18-5305	18-5349 ① 18-5348 ②	18-5428	18-5358 ① 18-5356 ②	18-5284 ①
AQ 140 A	18-7878	18-7862 18-7858	18-3075	18-4044	18-5305	18-5349 ① 18-5348 ②	18-5428	18-5356	—

④ Distributor # 0231153010 & 0231153012  
 ⑤ Distributor # 0231178011  
 ⑥ Distributor # 0231110043  
 ⑦ Distributor # 0231178005  
 ⑧ Distributor # 0231116054 & 0231116060

⑨ Distributor # 0231121008  
 ⑩ Distributor # 0231311002  
 ⑪ Distributor # 0231178017  
 ⑫ Distributor # 0231178016 & 0231178018  
 ⑬ Alternator

① Mally flat cap  
 ② Mally tall cap  
 ③ S/N 20459 & below  
 ④ S/N 20460 & up

**TUNE-UP APPLICATION FOR GAS ENGINE MODELS**

									
Model Application	Oil Filter	Fuel Filter	Impeller	Drive Belt	Contact Set	Condenser	Rotor	Distributor Cap	Tune-Up Kit
BB 145 A	18-7878	18-7862 18-7858	18-3075	18-4044	18-5305	—	18-5428	18-5358	—
AQ 145 A	18-7878	18-7862 18-7858	18-3075	18-4044	18-5305	—	18-5428	18-5358	—
AQ 145 B	18-7878	18-7862 18-7858	18-3075	18-15435	18-5305	—	18-5428	18-5358	—
AQ 151 A	18-7878	18-7862 18-7858	18-3075	18-15435	18-5305	—	18-5428	18-5358	—
AQ 151 B	18-7878	18-7862 18-7858	18-3075	18-15435	18-5305	—	18-5428	18-5358	—
AQ 151 C	18-7878	18-7862 18-7858	18-3075	18-15435	18-5305	—	18-5428	18-5358	—
250 A	18-7878	18-7862 18-7858	18-3075	18-4044	18-5305	—	18-5428	18-5358	—
250 B	18-7878	18-7862 18-7858	18-3075	18-4044	18-5305	—	18-5428	18-5358	—
AQ 171 A	18-7878	18-7862 18-7858	18-3075	18-15435	—	—	—	—	—
AQ 171 C	18-7878	18-7862 18-7858	18-3075	18-15435	—	—	—	—	—
251 A	18-7878	18-7862 18-7858	18-3075	18-4044	—	—	—	—	—
3.0 GL	18-7824	—	18-3060	—	—	—	18-5406	18-5361	—
3.0 GS	18-7824	—	18-3060	—	—	—	18-5406	18-5361	—
AQ 175 A	18-7879	18-7862 18-7858	18-3081	18-4046	18-5303	18-5345	18-5403	18-5353	—
430 A	18-7879	18-7862 18-7858	18-3081	18-4046	—	—	18-5403	18-5353	—
430 B	18-7879	18-7862 18-7858	18-3081	18-4046	—	—	18-5403	18-5353	—
AQ 190A	18-7875	—	18-3061	—	18-5303	18-5345	18-5425	18-5369	—
AQ 200 B	18-7824	18-7862 18-7858	18-3060	18-4046 ⑤	18-5314 ④ 18-5303 ⑤	18-5338 ④ 18-5345 ⑤	18-5411 ④ 18-5403 ⑤	18-5375 ④ 18-5352 ⑤	18-5256 ④ 18-5260 ⑤
AQ 200 C	18-7824	18-7862 18-7858	18-3060	18-4046 ⑤	18-5314 ④ 18-5303 ⑤	18-5338 ④ 18-5345 ⑤	18-5411 ④ 18-5403 ⑤	18-5375 ④ 18-5352 ⑤	18-5256 18-5260 ⑤
AQ 200 D	18-7824	18-7862 18-7858	18-3081	18-4046	18-5303	18-5345	18-5425 ⑥ 18-5403 ⑤	18-5369 ⑥ 18-5352 ⑤	—
AQ 200 F	18-7824	18-7862 18-7858	18-3081	18-4046	18-5303	18-5345	18-5403	18-5352	18-5262
AQ 205 A	18-7879	18-7845 18-7858 18-7845	—	18-4046	—	—	18-5403	18-5353	—
431 A	18-7879	18-7845 18-7858	—	18-4046	—	—	18-5403	18-5353	—
431 B	18-7879	18-7845 18-7858	18-3081	18-4046	—	—	18-5403	18-5353	—
432 A	18-7879	18-7845 18-7858	18-3081	—	—	—	—	—	—
434 A	18-7879	18-7845 18-7858	18-3081	—	—	—	—	—	—
4.3 GL	18-7879	—	18-3060	—	—	—	18-5408	18-5362	—
4.3 GS	18-7879	—	18-3060	—	—	—	18-5408	18-5362	—
4.3 GI	18-7879	—	18-3081	—	—	—	—	—	—
AQ 211 A	18-7824	18-7858 18-7845	18-3081	18-4046	18-5303	18-5345	18-5403	18-5352	18-5260
500 A	18-7824	18-7858 18-7845	18-3081	18-4046	18-5303	18-5345	18-5403	18-5352	18-5260
500 B	18-7824	18-7858	18-3081	18-4046	—	—	18-5403	18-5352	—
AQ 225 B	18-7824	18-7862 18-7858	18-3060	18-4046 ⑤	18-5314 ④ 18-5303 ⑤	18-5338 ④ 18-5345 ⑤	18-5411 ④ 18-5403 ⑤	18-5375 ④ 18-5352 ⑤	18-5256 ④ 18-5260 ⑤
AQ 225 C	18-7824	18-7862 18-7858	18-3060	18-4046 ⑤	18-5314	18-5338	18-5411	18-5375	—
AQ 225 D	18-7824	18-7862 18-7858	—	18-4046	18-5303	18-5345	18-5425 ⑥ 18-5403 ⑤	18-5369 ⑥ 18-5352 ⑤	18-5264 ⑥ 18-5260 ⑤
AQ 225 E	18-7824	18-7862 18-7858	—	18-4046	18-5303	18-5345	18-5403	18-5352	18-5260
AQ 225 F	18-7824	18-7862 18-7858	—	18-4046	18-5303	18-5345	18-5403	18-5352	18-5260
BB 225 A	18-7824	18-7862 18-7858	18-3081	—	18-5303	18-5345	18-5403	18-5352	18-5260









④ Distributor # 0231153011 & 0231153012  
 ⑤ Distributor # 0231178011  
 ⑥ Distributor # 0231110043  
 ⑦ Distributor # 0231178005  
 ⑧ Distributor # 0231116054 & 0231116060

⑨ Distributor # 0231121008  
 ⑩ Distributor # 0231311002  
 ⑪ Distributor # 0231178017  
 ⑫ Distributor # 0231178016 & 0231178018  
 ⑬ Alternator

⑭ Mally flat cap  
 ⑮ Mally tall cap  
 ⑯ S/N 20459 & below  
 ⑰ S/N 20460 & up



TUNE-UP APPLICATION FOR GAS ENGINE MODELS

									
Model Application	Oil Filter	Fuel Filter	Impeller	Drive Belt	Contact Set	Condenser	Rotor	Distributor Cap	Tune-Up Kit
BB 225 B	18-7824	18-7862 18-7858	18-3081	18-4046	18-5303	18-5345	18-5403	18-5352	18-5260
BB 225 C	18-7824	18-7845 18-7858	18-3081	18-4046	18-5303	18-5345	18-5403	18-5352	18-5260
AQ 231 A	18-7824	18-7845 18-7858	18-3081	18-4046	18-5303	18-5345	18-5403	18-5352	18-5260
AQ 231 B	18-7824	18-7845 18-7858	18-3081	18-4046	18-5303	18-5345	18-5403	18-5352	18-5260
BB 231 A	18-7824	18-7845 18-7858	—	18-4046	18-5303	18-5345	18-5403	18-5352	18-5260
501 A	18-7824	18-7845 18-7858	18-3081	18-4046	18-5303 ⑩	18-5345⑩	18-5403	18-5352	18-5260
501 B	18-7824	18-7845 18-7858	18-3081	18-4046 18-3081	—	—	18-5403	18-5352	—
5.0 FL	18-7875	—	18-3060	—	—	—	—	—	—
5.0 FI	18-7875	—	18-3060	18-3081	—	—	—	—	—
5.7 GL	18-7824	—	18-3060	—	—	—	—	—	—
5.7 GI	18-7824	—	18-3060	—	—	—	18-5405	18-5354	—
5.8 FL	18-7875	—	18-3060	18-3081	—	—	—	—	—
5.8 FI	18-7875	—	18-3060	18-3081	—	—	—	—	—
5.8 FSI	18-7875	—	18-3060	18-3081	—	—	—	—	—
AQ 240 A	18-7875	—	18-3061	—	18-5303	18-5345	18-5425	18-5369	18-5264
AQ 255 A	18-7824	18-7862 18-7858	—	18-4046	18-5314	18-5338	18-5411	18-5375	18-5256
AQ 255 B	18-7824	18-7862 18-7858	18-3081	18-4046	18-5303	18-5345	18-5425⑥ 18-5403⑧	18-5369⑥ 18-5352⑥	18-5260⑥
AQ 260 A	18-7824	18-7862 18-7858	18-3081	18-4046	18-5303	18-5345	18-5425⑥ 18-5403⑧	18-5369⑥ 18-5352⑥	18-5260
AQ 260 B	18-7824	18-7862 18-7858	—	18-4046	18-5303	18-5345	18-5403	18-5352	18-5260
BB 260 A	18-7824	18-7862 18-7858	18-3081	18-4046	18-5303	18-5345	18-5403	18-5352	18-5260
BB 260 B	18-7824	18-7862 18-7858	18-3081	18-4046	18-5303	18-5345	18-5403	18-5352	18-5260
BB 260 C	18-7824	18-7862 18-7858	18-3081	18-4046	18-5303	18-5345	18-5403	18-5352	18-5260
BB 261 A	18-7824	18-7845 18-7858	18-3081	18-4046	18-5303	18-5345	18-5403	18-5352	18-5260
AQ 271 A	18-7824	18-7845 18-7858	18-3081	18-4046	—	—	18-5403	18-5352	—
AQ 271 B	18-7824	18-7845 18-7858	18-3081	18-4046	—	—	18-5403	18-5352	—
AQ 271 C	18-7824	18-7845 18-7858	18-3081	18-4046	—	—	18-5403	18-5352	—
AQ 271 D	18-7824	18-7845 18-7858	18-3081	18-4046	—	—	18-5403	18-5352	—
570 A	18-7824	18-7845 18-7858	18-3081	18-4046	—	—	18-5403	18-5352	—
572 A	18-7824	18-7845 18-7858	18-3081	18-4046	—	—	18-5403	18-5352	—
570 A/MS 4A	18-7824	18-7845 18-7858	18-3081	18-4046	—	—	18-5403	18-5352	—
AQ 280 A	18-7824	18-7862 18-7858	18-3081	18-4046	18-5303	18-5345	18-5425⑥ 18-5403⑧	18-5369⑥ 18-5352⑥	18-5260⑥
AQ 290 A	18-7824	18-7862 18-7858	18-3081	18-4046	18-5303	18-5345	18-5425⑥ 18-5403⑧	18-5369⑥ 18-5352⑥	18-5260⑥
AQ 311 A	18-7824	18-7845 18-7858	18-3081	18-4046	—	—	18-5403	18-5352	—
AQ 311 B	18-7824	18-7845 18-7858	18-3081	18-4046	—	—	18-5403	18-5352	—
571 A	18-7824	18-7845 18-7858	18-3081	18-4046	—	—	18-5403	18-5352	—
740 A	—	18-7845	—	—	—	—	18-5403	18-5352	—
740 B	18-7824	18-7845	—	—	—	—	18-5403	18-5352	—
7.4 GL	18-7824	—	18-3081 18-3060	—	—	—	—	—	—
7.4 GI	18-7824	—	18-3081	—	—	—	18-5405	18-5362	—
7.4 GSI	18-7824	—	18-3081	—	—	—	—	—	—
8.2 GL	18-7824	—	18-3081 18-3060	—	—	—	—	—	—

④ Distributor # 0231153010 & 0231153012  
 ⑤ Distributor # 0231178011  
 ⑥ Distributor # 0231110043  
 ⑦ Distributor # 0231178005  
 ⑧ Distributor # 0231116054 & 0231116060

⑨ Distributor # 0231121008  
 ⑩ Distributor # 0231311002  
 ⑪ Distributor # 0231178017  
 ⑫ Distributor # 0231178016 & 0231178018  
 ⑬ Alternator

⑭ Mallory flat cap  
 ⑮ Mallory tall cap  
 ⑯ S/N 20459 & below  
 ⑰ S/N 20460 & up

TUNE-UP APPLICATION FOR DIESEL ENGINE MODELS

									
Model Application	Oil Filter	Fuel Filter	Impeller	Drive Belt	Model Application	Oil Filter	Fuel Filter	Impeller	Drive Belt
2001, B	18-7884	18-7858	18-3076	—	TAMD 31 D	18-7878	—	18-3077	—
2002, B	18-7884	18-7858	18-3076	—	AD 31 D	18-7878	—	18-3077	—
2003, B	18-7884	18-7858	18-3076	—	AD 31 XD	18-7878	—	18-3077	—
2003 T,TB	18-7884	18-7858	18-3081	—	TMD 31 L-A	18-7878	—	18-3077	—
MD 2010 A,B	—	18-7858	18-3079	—	TAMD 31	—	—	—	—
MD 2020 A,B	—	18-7858	18-3079	—	P,L,M-A	18-7878	—	18-3077	—
MD 2030 A,B	—	18-7858	18-3080	—	AD 31 P,L-A	18-7878	—	18-3077	—
MD 2040 A,B	—	18-7858	18-3080	—	—	—	—	—	—
MD 1	—	—	18-3079 ②	—	MD 40 A	—	—	18-3077	—
MD 1 B	18-7884	—	18-3079	—	—	—	—	—	—
MD 2	18-7884	—	18-3079 ③	—	TMD 40 A	—	—	18-3077	—
MD 2 B	18-7884	—	18-3079	—	—	—	—	—	—
AQD 2 B	18-7884	—	18-3079	—	AQD 40 A	—	—	18-3077	—
MD 3 B	18-7884	—	18-3080	—	—	—	—	—	—
MD 5 A	18-7884	—	18-3076	—	TAMD 40 A	—	—	18-3078	—
MD 5 B	18-7884	—	18-3076	—	—	—	—	—	—
MD 5 C	18-7884	—	18-3076	—	AQAD 40 A	—	—	18-3078	—
MD 6 A	18-7884	—	18-3079	—	—	—	—	—	—
MD 6 B	18-7884	—	18-3076	—	TMD 40 B	—	—	18-3077	—
MD 7 A	18-7884	—	18-3076	—	—	—	—	—	—
MD 7 B	18-7884	—	18-3076	—	TAMD 40 B	—	—	18-3078	—
MD 11 C	18-7884	—	18-3076	—	—	—	—	—	—
MD 11 D	18-7884	—	18-3076	—	AQAD 40 B	—	—	18-3078	—
MD 17 C	18-7884	—	18-3080	—	—	—	—	—	—
MD 17 D	18-7884	—	18-3080	—	TMD 40 C	—	—	18-3077	—
MD 22 A	—	—	18-3081	—	TMD 41 A	—	—	18-3077	—
MD 22 L-A	—	—	18-3081	—	AQD 41 A	—	—	18-3077	—
TMD 22 A	—	—	18-3081	—	D 41 A	—	—	18-3077	—
—	—	—	18-3081 ④	—	TAMD 41 A	—	—	18-3077	—
AQD 21 A	—	18-7858	18-3075 ⑤	18-15460	AQAD 41 A	—	—	18-3077	—
—	—	—	18-3081 ④	—	AD 41 A	—	—	18-3077	—
MD 21 A	—	18-7858	18-3075 ⑤	18-15460	TMD 41 B	—	—	18-3077	—
—	—	—	18-3081 ④	—	D 41 B	—	—	18-3077	—
AQD 21 B	—	18-7858	18-3075 ⑤	18-15460	TAMD 41 B	—	—	18-3077	—
—	—	—	18-3081 ④	—	AD 41 B	—	—	18-3077	—
MD 21 B	—	18-7858	18-3075 ⑤	18-15460	KAMD 42 A	—	—	18-3077	—
AQD 32 A	—	18-7858	18-3077	—	KAD 42 A	—	—	18-3077	—
MD 32 A	—	18-7858	18-3077	—	TMD 41 D	—	—	18-3077	—
MD 30 A	18-7878	—	18-3077	—	D 41 D	—	—	18-3077	—
TMD 30 A	18-7878	—	18-3077	—	TAMD 41 D	—	—	18-3077	—
TAMD 30 A	18-7878	—	18-3077	—	AD 41 D	—	—	18-3077	—
AQAD 30 A	18-7878	—	18-3077	—	TMD 41 L-A	—	—	18-3077	—
MD 31 A	18-7878	—	18-3077	—	D 41 L-A	—	—	18-3077	—
TMD 31 A	18-7878	—	18-3077	—	TAMD 41	—	—	—	—
AQAD 31 A	18-7878	—	18-3077	—	P,L,M,H-A	—	—	18-3077	—
AD 31 A	18-7878	—	18-3077	—	KAMD 42 B	—	—	18-3077	—
TMD 31 B	18-7878	—	18-3077	—	KAD 42 B	—	—	18-3077	—
TAMD 31 B	18-7878	—	18-3077	—	KAMD 42 P-A	—	—	18-3077	—
AD 31 B	18-7878	—	18-3077	—	KAD 42 P-A	—	—	18-3077	—
TMD 31 D	18-7878	—	18-3077	—	—	—	—	—	—

② S/N 14016 & up

④ S/N 103386 & below

③ S/N 4211- & up

⑤ S/N 103387 & up



**18-5256  
TUNE-UP KIT**  
— CONTAINS —

Part #	O.E. #	Description
18-5314	835304	Contact Set
18-5338	835308-8	Condenser
18-5411	841243	Rotor



**18-5257  
TUNE-UP KIT**  
— CONTAINS —

Part #	O.E. #	Description
18-5306	240149	Contact Set
18-5342	243653	Condenser
18-5428	243903	Rotor

Bosch 4 cyl.



**①18-5260D** Display Package

**18-5260  
TUNE-UP KIT**  
— CONTAINS —

Part #	O.E. #	Description
18-5303	835705, 855846-2	Contact Set
18-5345	835704	Condenser
18-5403	855845	Rotor

Prestolite



**18-5264  
TUNE-UP KIT**  
— CONTAINS —

Part #	O.E. #	Description
18-5303	835705, 855846-2	Contact Set
18-5345	835704	Condenser
18-5425	834975	Rotor

V-8 with Prestolite clip-down cap



**18-5265  
TUNE-UP KIT**  
— CONTAINS —

Part #	O.E. #	Description
18-5305	243799, 1306169, 243460	Contact Set
18-5348	834560	Condenser
18-5428	243903	Rotor



**18-5266  
TUNE UP KIT**  
Fits: Flame Thrower Distributors 18-5481, 18-5482, 18-5483, 18-5477, 18-5478, 18-5479



**①18-5284D** Display Package

**18-5284  
TUNE-UP KIT**  
— CONTAINS —

Part #	O.E. #	Description
18-5305	243799, 1306169, 243460	Contact Set
18-5349	841262	Condenser
18-5428	243903	Rotor



**18-5303  
CONTACT SET**  
Replaces: 835705, 855846-2



**18-5305  
CONTACT SET**  
Replaces: 243460, 243799, 1306169



**18-5306  
CONTACT SET**  
Replaces: 240149



**18-5310  
CONTACT SET**  
Replaces: 818701-5



**18-5314  
CONTACT SET**  
Replaces: 835304



**18-5319  
CONTACT SET**  
Replaces: 243801



**18-5338  
CONDENSER**  
Replaces: 835308-8



**18-5342  
CONDENSER**  
Replaces: 243653



**18-5345  
CONDENSER**  
Replaces: 835704



**18-5347  
CONDENSER**



**18-5349  
CONDENSER**  
Replaces: 841262  
For: Bosch Distributors



**18-5348  
CONDENSER**  
Replaces: 834560



**18-5403  
ROTOR**  
Replaces: 855845, 841907, 3853801



**18-5404-1  
ROTOR**



**18-5405  
ROTOR**  
Replaces: 3854549-7  
V-8 Fits new GM style  
"Module in Cap"





**18-5406  
ROTOR**  
Replaces: 3854261  
For: 3.0L

**SEE PAGES 811-814 FOR APPLICATION**  
① Items ending in "D" are Display Packaged - Regular number is Non-Display

 <p><b>18-5408</b> <b>ROTOR</b> Replaces: 3854311-2 V-6 Fits new GM style "Module in Cap"</p>	 <p><b>18-5411</b> <b>ROTOR</b> Replaces: 841243</p>	 <p><b>18-5413</b> <b>ROTOR</b> For: 5.0L FI, FL, 5.8L FL, FI, FSI</p>	 <p><b>18-5419</b> <b>ROTOR</b> Replaces: 818525-8</p>	
 <p><b>18-5425</b> <b>ROTOR</b> Replaces: 834975</p>	 <p><b>18-5428</b> <b>ROTOR</b> Replaces: 243903</p>	 <p><b>18-5248</b> <b>DISTRIBUTOR CAP</b> Replaces: 3854217 For: 5.0FIPMDA, 5.0FIPMDM, 5.8FIPMDA, 5.8FIPMDM, 5.0FIPHUBCE, 5.0FIPHUCCE, 5.0FIPHUECE, 5.0FIPHURCE, 5.0FIPHUSCE, 5.0FLPHUB, 5.0FLPHUC, 5.0FLPHUE, 5.0FLPHUR, 5.0FLPHUS, 5.8FIIHU, 5.8FIP</p>	 <p><b>18-5301</b> <b>TUNE-UP KIT</b> Replaces: Fits: male cap v-8 flamethrower distributors</p>	
 <p><b>18-5302</b> <b>TUNE-UP KIT</b> Replaces: Fits: male cap v-8 flamethrower distributors</p>	 <p><b>18-5352</b> <b>DISTRIBUTOR CAP</b> Replaces: 841070</p>	 <p><b>18-5353</b> <b>DISTRIBUTOR CAP</b> Replaces: 841926</p>	 <p><b>18-5354</b> <b>DISTRIBUTOR CAP</b> Replaces: 3854548-9 V-8 Fits new GM style "Module in Cap"</p>	 <p><b>18-5356</b> <b>DISTRIBUTOR CAP</b> Replaces: 243797</p>
 <p><b>18-5357</b> <b>DISTRIBUTOR CAP</b> Replaces: 870690</p>	 <p><b>18-5358</b> <b>DISTRIBUTOR CAP</b> Replaces: 841263</p>	 <p><b>18-5361</b> <b>DISTRIBUTOR CAP</b> Replaces: 3854260 For: 3.0L</p>	 <p><b>18-5362</b> <b>DISTRIBUTOR CAP</b> Replaces: 3854331-0 V-6 Fits new GM style "Module in Cap"</p>	 <p><b>18-5369</b> <b>DISTRIBUTOR CAP</b> Replaces: 835702 with 18-5399 Gasket</p>
 <p><b>18-5375</b> <b>DISTRIBUTOR CAP</b> Replaces: 841244</p>	 <p><b>18-5393</b> <b>DISTRIBUTOR CAP</b> Replaces: 241669</p>	 <p><b>18-5473</b> <b>DISTRIBUTOR CAP</b> Black Distributor Cap w/ Male Terminals Petronix Dsistributors</p>	 <p><b>18-5474</b> <b>DISTRIBUTOR CAP</b> Red Distributor Cap with Male Terminals Petronix Dsistributors</p>	 <p><b>18-7492</b> <b>COIL</b> Replaces: 3854161 For: 1996 applications</p>

SEE PAGES 811-814 FOR APPLICATION

 <p><b>18-7493 COIL</b> Replaces: 3859078 For: 8.1L 2001-2007</p>	 <p><b>18-5745 IGNITION COIL</b> Replaces: 3287677 Fits: AQ171A, AQ171C 251A (1988-92)</p>	 <p><b>18-7648 IGNITION COIL</b> Replaces: 3861267 Fits: 8.1Gi-A, 8.1Gi-B, 8.1Gi-BF, 8.1Gi-C, 8.1Gi-CF, 8.1Gi-D, 8.1Gi-DF, 8.1GSi-A, 8.1GXi-A, 8.1GXi-AF, 8.1GXi-B, 8.1GXi-BF, 8.1GXi-C</p>	 <p><b>18-5434 IGNITION COIL</b> Replaces: 835998 Uses External Resistor</p>
--	--	--	--

 <p><b>18-5436 IGNITION COIL</b> Replaces: 35254 Has Internal Resistor</p>	 <p><b>18-5443 IGNITION COIL</b> Replaces: 3854002-7 3.0L/4.3L/5.7L/7.4L</p>	 <p><b>18-5107-1 IGNITION MODULE</b> Replaces: 3854003</p>	 <p><b>18-5464 IGNITION MODULE</b> Fits: Sierra 18-5481, 18-5482 and 18-5483 Billet HI-PERFORMANCE ELECTRONIC DISTRIBUTORS (except HEI/EST)</p>	 <p><b>18-5108 PICK-UP COIL SENSOR</b> Replaces 3854001</p>
---	---	---	--	--

 <p><b>18-7757 THROTTLE POSITION SENSOR</b> Replaces: 3855296 Fits: 1995-2001</p>	 <p><b>18-7642 PICK-UP ASSEMBLY</b> Replaces: 3863130 Fits: 3.0, 4.3, 5.0, 5.7L models (2002-07)</p>	 <p><b>18-7643 CAMSHAFT SENSOR</b> Replaces: 3859082 Fits: 8.1Gi-A, 8.1Gi-B, 8.1Gi-BF, 8.1Gi-C, 8.1Gi-CF, 8.1Gi-D, 8.1Gi-DF, 8.1GSi-A, 8.1GXi-A, 8.1GXi-AF, 8.1GXi-B, 8.1GXi-BF, 8.1GXi-C, 8.1Gi-E, 8.1Gi-EF, 8.1GXi-D, 8.1GXi-DF, 8.1OSi-A, 8.1OSi-AF, 8.1GiI-E, 8.1GXii-D (2001-07)</p>	 <p><b>18-7706 CRANKSHAFT POSITION SENSOR</b> Replaces: 3858979 Fits: 4.3, 5.0, 5.7L models</p>	 <p><b>18-7708 CRANKSHAFT POSITION SENSOR</b> Replaces: 3808516 Fits: Most 8.1L</p>
---	--	---	---	---

## FEATURES

- ★ Oil filled for better cooling and long life
- ★ Low resistance and improved turn ratios produces the higher voltage needed to run larger spark plug gaps for added power and better fuel economy
- ★ More windings maximize energy and reliability over the full RPM range
- ★ Fits existing brackets for easy installation

 <p><b>18-5466 HI-PERFORMANCE IGNITION COIL</b> 1.5 ohm (oil filled), black - 8 cylinder: Flame-Thrower 40,000 volt coil. ★ Designed for use with the original Ignitor Electronic Conversion Kits ★ Can be used with other inductive ignition systems</p>	 <p><b>18-5469 HI-PERFORMANCE IGNITION COIL</b> 3.0 ohm (oil filled), black - 4 &amp; 6 cylinder: Flame-Thrower 40,000 volt coil. ★ Designed for use with the original Ignitor Electronic Conversion Kits ★ Can be used with other inductive ignition systems</p>	 <p><b>18-5472 HI-PERFORMANCE IGNITION COIL</b> 0.6 ohm (oil filled), black - 4, 6, &amp; 8 cylinder: Flame-Thrower 45,000 volt coil. ★ Super low 0.6 ohm resistance coil designed for use with the Ignitor II Hi Performance Electronic Conversion Kits ★ Compatible with capacitive discharge systems</p>
--	---	--

Part #	Description	Recommended Coil	Resistance Ohms	Part #	Description	Recommended Coil	Resistance Ohms
18-5294	Electronic Conversion Kit	18-5469	3.0	18-5286	Hi Performance Electronic Conversion Kit	18-5472	0.6
18-5295	Electronic Conversion Kit	18-5469	3.0	18-5289	Hi Performance Electronic Conversion Kit	18-5472	0.6
18-5299	Electronic Conversion Kit	18-5466	1.5	18-5483	Flame-Thrower Distributor	18-5472	0.6

SEE PAGES 811-814 FOR APPLICATION



# FEATURES

- ★ *Distributors feature the Ignitor II ignition module with adaptive dwell control adjusts the spark timing over the entire RPM range to maximize performance*
- ★ *Upper roller bearing and oil impregnated bronze sintered bottom bushing are installed and aligned bored for accuracy for maximum durability*
- ★ *Machined heat treated gear with tight tolerances insures durability and consistent timing to maximize horsepower and performance. Complete with high dielectric strength cap and rotor for years of performance*

Standard Rotation

CCW Rotation

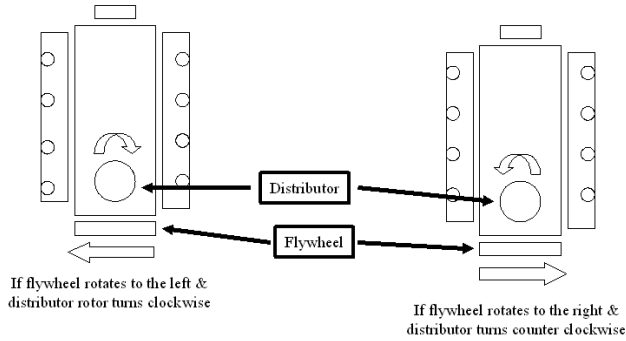

**18-5483**  
**HI-PERFORMANCE ELECTRONIC DISTRIBUTOR**

Fits: Chevrolet Marine Small and Big Block engines (Standard Deck Height)  
Replacement cap/rotor kit 18-5266



**18-5475**  
**DISTRIBUTOR**  
Fits: 4 Cyl GM w/ Delco EST Ignition



**18-5484-1**  
**ELECTRONIC DISTRIBUTOR (Late HEI)**  
Replaces: Mallory YLE624AV  
For Left Hand Rotation V8/RH 262-454 & 502 (Except 348/409 and Tall Block Engines)  
• Designed as a plug-in replacement for GM-style fuel ignition system distributor

—CONTAINS—

Part #	Description
18-5354	Distributor Cap
18-5405	Rotor



**18-5485**  
**ELECTRONIC DISTRIBUTOR (Late HEI)**  
Replaces: Mallory YLE624BV  
For Right Hand Rotation V8/RH 262-454 & 502 (Except 348/409 and Tall Block Engines)  
• Designed as a plug-in replacement for GM-style fuel ignition system distributor

—CONTAINS—

Part #	Description
18-5354	Distributor Cap
18-5405	Rotor



**18-5494-1**  
**ELECTRONIC DISTRIBUTOR**  
Replaces: Mallory YLM624AV  
Conventional Rotation  
For Chevrolet all V8 includes 482, 502, 540 CID (Except 348,409 & Tall Deck Big Block)

—CONTAINS—

Part #	Description
18-5376	Distributor Cap
18-5488	Module
18-5404-1	Rotor



**18-5498-1**  
**ELECTRONIC DISTRIBUTOR**  
Replaces: Mallory YLM624BV  
Reverse Rotation  
For Chevrolet all V8 includes 482, 502, 540 CID (Except 348,409 & Tall Deck Big Block)

—CONTAINS—

Part #	Description
18-5376	Distributor Cap
18-5488	Module
18-5404-1	Rotor



**18-5480**  
**COMPLETE IGNITION CONVERSION KIT**  
Fits: GM SB & BB with Standard Deck Height

—CONTAINS—

Part #	Description
18-5472	Coil
18-8803-2	Wire Set
18-5483	Distributor



**18-5477**  
**ELECTRONIC DISTRIBUTOR**  
Fits: Ford 302 V-8 engines



**18-5478**  
**ELECTRONIC DISTRIBUTOR**  
Fits: Chrysler LA series V-8 engines



**18-5479**  
**ELECTRONIC DISTRIBUTOR**  
Fits: GM V-8 engines-reverse rotation



**FEATURES**

- ★ Senses current levels in the coil and adjusts the dwell to maintain peak energy throughout the entire RPM range.
- ★ Develops, on average, 4 times more available energy between 3000 and 5000 RPM's and twice as much plug voltage as point-type systems.
- ★ Ignition energy is sustained and coil life is increased when peak current level is reached just prior to spark.
- ★ More stable timing.
- ★ Use with 18-5472 "Flame Thrower II" Coil for optimum performance



**18-5286**  
**HI-PERFORMANCE**  
**ELECTRONIC CONVERSION KIT**  
Fits: 6 Cylinder Delco Distributors



**18-5288**  
**HI-PERFORMANCE**  
**ELECTRONIC CONVERSION KIT**  
Fits: Most Prestolite V-8 Distributors with snap down cap



**18-5289**  
**HI-PERFORMANCE**  
**ELECTRONIC CONVERSION KIT**  
Fits: Most Prestolite V-8 Distributors with screw down cap



**FEATURES**

- ★ Replaces points & condensers for true solid state ignition.
- ★ Uses standard coil, cap and rotor.
- ★ Easy to install, one-piece, 2-wire hook-up.
- ★ Accurate to within 1/4° timing accuracy 0 to 6000 RPM range.

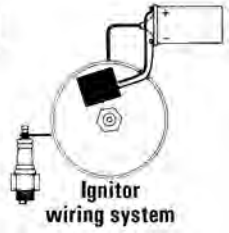
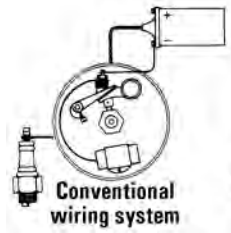

**18-5292**  
**ELECTRONIC**  
**CONVERSION KIT**  
Fits: 4 Cylinder Volvo AQ Models with Bosch Ignition (Dist # 0231178017)



**18-5294**  
**ELECTRONIC**  
**CONVERSION KIT**  
Fits: (6 Cyl.) Delco distributors



**18-5295**  
**ELECTRONIC**  
**CONVERSION KIT**  
Fits: Most 4 Cyl. Prestolite distributors (except IBM7026) For: Onan, Universal, Waukesha, Wisconsin

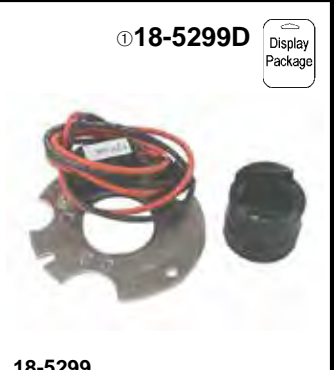

**18-5299D**  
**ELECTRONIC**  
**CONVERSION KIT**  
Fits: 8 (Cyl.) AQ200A, B, AQ225A, B and All 8 Cyl. w/Prestolite Dist # IBM-7013A Use with 18-5403 style rotor

Display Package

① Items ending in "D" are Display Packaged - Regular number is Non-Display

**PREMIUM MARINE SPARK PLUG WIRE LEADS**

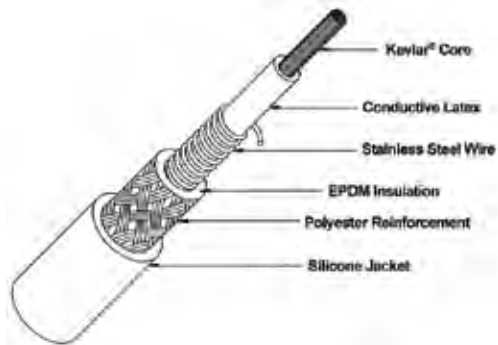

OE style boots provide a sealed barrier against heat, dirt and moisture.

**Premium Marine Wire Leads**  
**Magnetic Suppression Core**  
**Manufactured for your specific application**

- ★ Kevlar® core for maximum durability and long life.
- ★ Durable stainless steel wound conductor for maximum horsepower and engine performance.
- ★ Premium silicone jacketing and boots for the ultimate in high temperature protection.
- ★ Superior RFI suppression for the most sensitive electronic system.
- ★ Corrosion resistant stainless steel spark plug and distributor terminals for maximum conductivity.

Model	Cyl.	Part #	Model	Cyl.	Part #
AQ120B	4	18-8813-1 ①	AQ255A-F	8	18-8802-1
AQ125A,B	4	18-8813-1 ①	AQ255A-F	8	18-8823-1 ②
AQ131A-D	4	18-8813-1 ①	AQ260A,B	8	18-8802-1
AQ140A	4	18-8813-1 ①	AQ260A,B	8	18-8823-1 ②
AQ145A,B	4	18-8813-1 ①	AQ271A-D	8	18-8802-1
AQ151A-C	4	18-8813-1 ①	AQ271A-D	8	18-8823-1 ②
AQ175A	V6	18-8801-1	AQ290A	8	18-8802-1
AQ190A	8	18-8802-1	AQ290A	8	18-8823-1 ②
AQ190A	8	18-8823-1 ②	AQ311A,B	8	18-8802-1
AQ200B-F	8	18-8802-1	AQ311A,B	8	18-8823-1 ②
AQ200B-F	8	18-8823-1 ②	BB140A	4	18-8813-1 ①
AQ205A	V6	18-8801-1	BB145A	4	18-8813-1 ①
AQ211A	8	18-8802-1	BB225A-C	8	18-8802-1
AQ211A	8	18-8823-1 ②	BB225A-C	8	18-8823-1 ②
AQ225B,D	8	18-8802-1	BB231A	8	18-8802-1
AQ225B,D	8	18-8823-1 ②	BB231A	8	18-8823-1 ②
AQ231A,B	8	18-8802-1	BB260A-C	8	18-8802-1
AQ231A,B	8	18-8823-1 ②	BB260A-C	8	18-8823-1 ②
AQ240A	8	18-8802-1	BB261A	8	18-8802-1
AQ240A	8	18-8823-1 ②	BB261A	8	18-8823-1 ②

Model	Ignition Type	Cyl.	O.E. #	Part #
AQ120B/ AQ125A/ AQ131A-D	Conventional	4	875571	18-8813-1
AQ140A/ AQ145A, B/ AQ151A-C	Conventional	4	875571	18-8813-1
BB140A/ BB145A	Conventional	4	875571	18-8813 -1
AQ175/ AQ205A	All Prestolite	6	876532-3	18-8801-1
AQ190A/ AQ200BF/ AQ211A	All Prestolite	8	8757166	18-8802-1/ 18-8823-1 ②
AQ225B,D/ AQ231A,B AQ240A	All Prestolite	8	8757166	18-8802-1/ 18-8823-1 ②
AQ225A,F/ AQ260A,B/ AQ271A-D	All Prestolite	8	8757166	18-8802-1/ 18-8823-1 ②
AQ290A/ AQ311A,B	All Prestolite	8	8757166	18-8802-1/ 18-8823-1 ②
BB225A-C/ BB231A	All Prestolite	8	8757166	18-8802-1/ 18-8823-1 ②
BB260A-C/ BB261A	All Prestolite	8	8757166	18-8802-1/ 18-8823-1 ②

① 18-8813-1 uses 7mm Wire

② For models with Mallory side terminal design





**BATTERY CABLES**  
Gauge cable with soldered lug terminals on each end to accept a 3/8" stud.

Part No.	Size	Color	Gauge
BC88523	2'	red	4
BC88533	2'	black	4
BC88543	4'	red	2
BC88553	4'	black	2
BC88563	6'	red	2
BC88573	6'	black	2
BC88583	8'	red	1
BC88593	8'	black	1



**18-5226**  
**IGNITION WIRE**  
**Metallic Core**  
100' Spool  
7mm Hypalon



**18-5225**  
**SPARK PLUG WIRE KIT**  
Replaces:  
Mercury 84-99215A26, 84-813706A26  
Kit includes 25 ft. Roll of 7 MM Hypalon Ignition Wire With a Metallic Core and a Large Assortment of Three Different End Fittings.



**18-5224**  
**18-5224-9①**  
**SPARK PLUG WIRE TERMINAL**  
Replaces: Mercury 20121  
OMC 510364



**18-5750**  
**18-5750-9①**  
**UNIVERSAL SPARK PLUG BOOTS**  
Supplied complete w/Terminal Connector  
Replaces: OMC 581027, 580339



**18-5752**  
**UNIVERSAL SPARK PLUG BOOT**  
8mm



**18-5657**  
**PROTECTING SLEEVE**  
Replaces: 855798  
Fits: Most Volvo gas & diesel engines

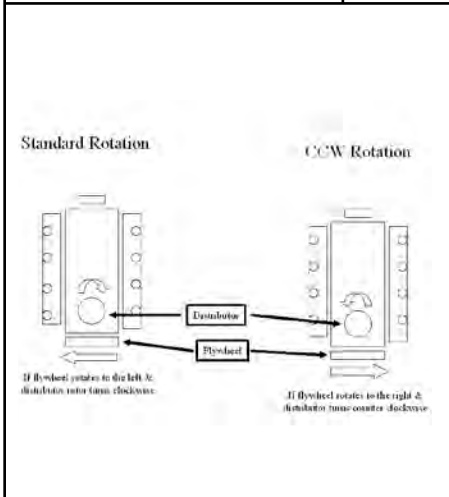

**18-5923**  
**STARTER**  
PMGR, Ford



**18-5927**  
**STARTER**  
PMGR, Ford



**18-5911**  
**STARTER**



**18-5900**  
**REMANUFACTURED STARTER**

**(Heavy-Duty) (No Core) Clockwise**  
**For GM engines, bottom mount straight across bolt pattern. Standard rotation.**  
Replaces: 834893, 855326  
Replacement Solenoid: 18-5837  
**SAEJ1171**



**18-5903**  
**STARTER**  
Replaces: 841066-4  
(No Core)Clockwise  
Bottom mount two bolt pattern for standard rotation FORD engines.  
Replacement Solenoid: 18-5801

① Priced per Package



CE

**18-5906**  
**REMANUFACTURED STARTER**  
 Replaces: 840808  
 (No Core) Clockwise  
 Starter for late model 4 cyl. gas engines.  
 Both ears are threaded.  
 Replacement Solenoid: 18-5809



CE

**18-5913**  
**STARTER**  
 Replaces: 3856004, 3860764,  
 3587625, 3853982, 3854751, 3885317  
 (Clockwise)  
 Delco permanent magnet gear reduction 2  
 bolt starter. 12V - 11 Tooth Offset Bolt Pattern  
 For: Late model GM 14" Flywheel  
 Replacement Solenoid: 18-6287  
**SAEJ1171**  
 1.7 KW



CE

**18-5919**  
**STARTER**  
 Replaces: 3856003  
 Permanent magnet I/O starter  
 Fits: Chevy Engines with 14" flywheels  
 Straight across bolt pattern  
 Replacement Solenoid: 18-6287  
**SAEJ1171**  
 For: 3.0 GS  
 1.7 KW



CE

**18-5920**  
**STARTER**  
 Replaces: 3854190  
 Permanent magnet starter  
 Replacement Solenoid: 18-6291  
 For: 5.0 & 5.8 litre Ford engines



**18-6275**  
**STARTER**  
 Replaces: 3857747, 3860566  
 • Inboard  
 • Permanent Magnet Gear Reduction Starter  
 • 2 Long Bolt Offset Pattern  
 • CW Rotation  
 • Use w/ Late Model 3.0L Engines with 14"  
 Flywheel  
 Replacement Solenoid: 18-6287  
 Fits : Volvo Penta, Mercruiser, Marine Power



**18-6292**  
**STARTER**  
 Replaces: 872241  
 • Inboard  
 • Gear Reduction Starter  
 • Permanent Magnet, 12 Volt  
 • CW Rotation  
 • Aluminum Pinion Housing w/2 Threaded  
 Mounting Holes  
 Fits : Volvo Penta 4 Cylinder and 6 Cylinder  
 Gas Engines



**NEW**

**18-6834**  
**STARTER**  
 Replaces: GM Engines  
 Used on Buick, Chevrolet, Oldsmobile, and Pontiac Race  
 Engines



**NEW**

**18-6835**  
**STARTER**  
 Replaces: GM Engines  
 Used on Buick, Chevrolet, Oldsmobile, and Pontiac Race  
 Engines



**NEW**

**18-6839**  
**STARTER**  
 Replaces: 1357199, -7, 3523301, -4,  
 5003564, -1  
 Fits: 240,740,760,780,940 series 2.3L



**NEW**

**18-6872**  
**STARTER**  
 Replaces: 233991, 240501, 837924,  
 842775, 843511, 847306-8, 881681  
 Fits: TAMD, MD, AQD Models



**NEW**

**18-6956**  
**STARTER**  
 Replaces: 3803227, -2, 834625-6,  
 841378-3, 841380, 841762, 63, 65, 66,



**NEW**

**18-6958**  
**STARTER**  
 Replaces: 847308-4, 870998, 881682  
 Fits: MD, TMD, TAMD Models



**18-5882  
ALTERNATOR**  
Replaces: 3884950  
75A, 12V, Serpentine  
3.0L, 4.3L, 5.0L, 5.7L, 8.1L (2007 - Current)



**18-5957  
ALTERNATOR**

**18-5951  
ALTERNATOR  
REMANUFACTURED**  
Replaces: 3860769  
**(3-Wire) (68 AMP) (No Core)**  
Replaces Mando, Motorola and Original Equipment Delco.  
Uses same electrical connections and mounting method.  
Equipped with fan and drive pulley.  
**SAEJ1171**



**18-5970  
ALTERNATOR**  
Replaces: 3803227, -2, 834625-6,  
841378-3, 841380, 841762, 63, 65,  
66,



**18-5979  
ALTERNATOR**  
Replaces: 3860082, Mando AC165622,  
Lester 12391  
65 amp, 3.0GSM-A/B/C, 3.0GSP-A/B/C, 3.0GLM-A/B,  
3.0GLP-A/B, 4.3GXi-A/B/BF/C.CF.D.DF, 4.3OSi-B/BF/C/  
CF/D/DF, 5.0GXi-A



**18-6261  
ALTERNATOR**  
Replaces: 3856600-6, 3857561  
Mando for Late Model Volvo  
Penta, 12 Volt, 65 Amp,  
Internal Regulator, Single  
Groove Pulley



**18-5959  
ALTERNATOR**  
Replaces: 826495, 834609,  
834963, 841762, 841765, 841766.  
Valeo A13N1M, 2M, 147M, 148M  
**14V/50 AMP:** AQ120-AQ145, AQ200D-AD290-TMD40-  
MD21-8070-MD5C, MD18-7D-MD30-TMD30-TAM30,  
MD18-MD2B-MD2BHY-MD3B-MD21A, MD32A-  
AQD32A/270D (Mot V8S), MD5-MD7-MD11-MD17-B21-  
B22 Mot. TMD40), Series 2002-2003-R,V,S.



**18-5939  
ALTERNATOR**  
Replaces: 872235, 3803260, 873770  
Valeo: A13N234, 2541451

**14V/60 AMP:** AQ115, AQ120B, AQ125, AQ130, AQ140,  
AQ145, AQ165, AQ170, AQ200, AQ225, AQ256, AQ260,  
AQ280, AQ290, BB115, BB145, MB20; Diesel Engine Ap-  
plication: AQD2B, AQD21A, AQD21B, AQD27, AQD29, AQ-  
D32A, MD11C, MD11D, MD17C, MD17D, MD2B, MD2010A,  
MD2010B, MD2030A, MD2030B, MD2040A, MD2040B,  
MD21A, MD21B, MD27, MD29, MD3B, MD32A, MD6A,  
MD6B, MD7, TAM71A, TAM71B, TAM72A, TAM72WI-A.



**18-5943  
ALTERNATOR**  
Replaces: 872926, 3803227  
Valeo: A13N259, 541663  
**14V/50 AMP:** 431, 500, 501, 570, 740DP,  
740/MSS, AQ131, AQ145B, AQ175, AQ200,  
AQ205, AQ211, AQ225, AQ260, AQ271, AQ290,  
AQ311, BB165, BB170, BB225, BB231, BB260,  
BB261; Diesel Engine Application: 2001, 2002, 2003,  
2003T, AD31A, AQAD30A, AQAD31A, AQAD40A,  
AQAD41, AQAD41A, AQD40A, AQD41, AQD41A,  
KAD42A, KAMD42A, MD30A, MS31A, MD40A, MD7B,  
TAMD40A, TAM41A, TAM41B, TAM41D, TAM70E,  
TMD30A, TMD31A, TMD40A, TMD41A.



**18-6845  
ALTERNATOR**  
Replaces: 3862613, 3862665,  
3884950  
Fits: 3.0GLM, 3.0GLP Engines



**18-6846  
ALTERNATOR**  
Replaces: Volvo Penta 1502272, 3803270-  
2, 5001677, 845940, 72021, 872022,  
872757, 873635, 873757, 873757-9,  
873771,



**18-6847  
ALTERNATOR**  
Replaces: 3862613, 2655301,  
Fits: 2000-07 3.0GLP, GSP, GSM, 4.3GXi, 5.0GXi, Si,  
5.7Gi, GXi, Osi, Sxi



**18-6848**

**ALTERNATOR**

Replaces: Volvo 3862612, 2656299, Valeo A0002655299

Fits: 2000 and on Volvo Penta Models w/ 4.3, 5.0, and 5.7 GM engines



**18-6953**

**ALTERNATOR**

Replaces: Volvo

Fits: Diesel D3 Models



**18-6955**

**ALTERNATOR**

Replaces: Caterpillar 3001117, 10-258, Prestolite 110-258, 110-258A, Volvo 849748-9

Fits: Volvo Diesel 6 cylinder models

**ALTERNATOR/STARTER APPLICATION**

**GASOLINE ENGINES**

Model	Starter	Alternator	Model	Starter	Alternator
AQ115	18-5918	—	AQ280	18-5900	—
AQ120B	18-5918 ③	—	AQ290A	18-5900	18-5959
AQ120B	18-5906	—	AQ311A, B	18-5900	—
AQ125A	18-5918 ③	18-5959	BB115	18-5918	—
AQ125A,B	18-5906 ①	18-5959	BB140A	18-5918 ④	18-5959
AQ130	18-5918	—	BB140A	18-5906	—
AQ131A,B,C,D	18-5906	18-5959	BB145	18-5918	—
AQ140A	18-5918 ④	18-5959	BB145A	18-5918 ④	18-5959
AQ140A	18-5906 ①	18-5959	BB145A	18-5906 ②	—
AQ145	18-5918	18-5959	BB165, 170	18-5918	—
AQ145A	18-5918 ④	18-5959	BB225A,B,C	18-5900	18-5959
AQ145A,B	18-5906 ②	18-5959	BB260A	18-5900	18-5959
AQ151A,B,C	18-5906	18-5959	BB260B	18-5900	18-5959
AQ165	18-5918	—	BB260C	18-5900	18-5959
AQ170	18-5918	—	230, 250	18-5906	18-5943 ⑦
AQ171A,C	18-5906	18-5959 ⑩	251A	18-5906	—
AQ175A	18-5900 ④	—	430,431,432	18-5900	18-5943 ⑦ 18-5939 ⑤
AQ190A	18-5903	—	434	—	18-5943 ⑦ 18-5939 ⑤
AQ200B,C,D,F	18-5900	18-5959	500-570	18-5900	18-5943 ⑦ 18-5939 ⑤
AQ205A	18-5900	—	571A	18-5900	—
AQ211A	18-5900	—	572	18-5900	18-5943 ⑦ 18-5939 ⑤
AQ225A,B,C,D,E,F	18-5900	18-5959	740B	18-5900	18-5943 ⑦ 18-5939 ⑤
AQ231A, B	18-5900	—	3.0L (All models)	18-5919	—
AQ240A	18-5903	—	4.3L, 5.0 L, 5.7L,		
AQ255A,B	18-5900	—	7.4L, 8.2L (All models)	18-5913	—
AQ260A,B	18-5900	18-5959	5.0L, 5.8L		
AQ271A,B,C,D	18-5900	—	(All Ford models)	18-5920	—

① AQ125A beginning with S/N 7679/013489

② AQ145A & BB145A beginning with S/N 7705/001557

③ below S/N 7679/013489

④ below S/N 7705/001557

⑤ 18-5939 14V/50AMP

⑦ Mounting screw threads into bracket

⑩ 18-5959 14V/50AMP

**ALTERNATOR/STARTER APPLICATION**

**DIESEL ENGINES**

Model	Alternator	Model	Alternator	Model	Alternator
AD31B, D, XD	18-5943 ⑦	MD17	18-5959 ⑩	TAMD31B	18-5943 ⑦
AD31P, L	18-5939 ⑤	MD22A-A	18-5943 ⑦	TAMD31D	18-5943 ⑦
AD41D	18-5943 ⑦	MD22D-D	18-5939 ⑤	TAMD31L, M, P, S	18-5939 ⑤
D2-55A	18-5939 ⑤	MD22L-A	18-5943 ⑦	TAMD41B, D	18-5943 ⑦
D25A	18-5959 ⑩	MD22L-B	18-5939 ⑤	TAMD41L, M, P, S	18-5939 ⑤
D30A	18-5959 ⑩	MD31A	18-5943 ⑦	TAMD42B	18-5939 ⑤
D41D	18-5943 ⑦	MD201A	18-5939 ⑤	TAMD60C	18-5959 ⑩
D49A	18-5959 ⑩	MD201B	18-5939 ⑤	TAMD61A, 62A	18-5939 ⑤ 18-5959 ⑩
D63	18-5939 ⑤	MD201C	18-5939 ⑤	TAMD71A, 72A	18-5939 ⑤ 18-5959 ⑩
D71	18-5939 ⑤	MD202A	18-5939 ⑤	TAMD72P	18-5939 ⑤
D71D	18-5939 ⑤	MD202B	18-5939 ⑤	TAMD72WJ	18-5939 ⑤
D73	18-5939 ⑤	MD202C	18-5939 ⑤	TAMD100, 120	18-5976 ②
KAD42B	18-5939 ⑤	MD203A	18-5939 ⑤	TMD21D	18-5939 ⑤
KAMD42A	18-5943 ⑦	MD203B	18-5939 ⑤	TMD22A-A	18-5939 ⑤ 18-5943 ⑦
KAMD42B	18-5939 ⑤	MD203C	18-5939 ⑤	TMD22-B	18-5939 ⑤
MD5	18-5959 ⑩	MD204A	18-5939 ⑤	TMD31B, D, L	18-5943 ⑦
MD6	18-5959 ⑩	MD204B	18-5939 ⑤	TMD41B	18-5943 ⑦
MD7	18-5959 ⑩	MD204C	18-5939 ⑤	TMD41D, L	18-5939 ⑤
MD11	18-5959 ⑩	TAMD22D-B	18-5939 ⑤	2001, 2002, 2003	18-5943 ⑦

⑤ 18-5939 14V/50AMP

⑦ 18-5943 14V/50AMP

⑩ 18-5959 14V/50AMP

② 18-5976 28V/45AMP



**18-6291**  
**SOLENOID**  
 Replaces: 3854194-2, OMC 3854194  
 Fits: Ford Gear Reduction  
 Starters on Late Model 5.0L, 5.8L,  
 OMC and Volvo Penta



**18-5806**  
**SOLENOID**  
 Replaces: 834520  
 BOSCH 0331-302-050, 0331-302-081,  
 0331-302-085, 0331-302-581, 0331-302-585  
 For starters with aluminum nose.  
 Slot in end of solenoid shaft is 13/32" long.



**18-5811**  
**STARTER SOLENOID**  
 Replaces: 3850216, 3859054  
 For: PG 260 series starters, GM V6 & V8 (1983-Up)



**18-5837**  
**SOLENOID**  
 Replaces: 3853869, 3853998  
 For: 3.0 ; GL, GS, 4.3L GL, GS, 5.7L GL, GI,  
 7.4L GL, 8.2L GL



**18-9802**  
**TIMING LIGHT**  
 Self-powered accurate up to 10,000 RPM's



**18-6271**  
**RELAY**  
 Replaces: 870670, 6643474, 876038,  
 241812  
 12 Volt, 30 Amp



**18-6268**  
**RELAY**  
 Replaces: 841177, 872272  
 12 Volt, 30 Amp



**18-6266**  
**RELAY**  
 Replaces: 876040, 872300  
 12 Volt, 30 Amp



**18-5705**  
**POWER TRIM RELAY**  
 Replaces: 876039  
 5 Terminal  
 For: AQ 175, 200, 225D,  
 260, 290A

① 18-5705D



**18-5700**  
**TRIM RELAY**  
 Replaces:  
 3858081, 3858809  
 For: (1998 SX-M-MAC, MDA, MLT), 3.0GLP-D,  
 4.3GL-E, 4.3GL-EF, 4.3GXl-F, 4.3GXl-FF, 4.3OSl-F,  
 4.3OSl-FF, 5.0GL-F, 5.0GL-FF, 5.0GXl-F, 5.0GXl-FF,  
 5.0Sl-F, 5.0Sl-FF, 5.7GIl-F/FF, 5.7GXl-G/GF, 5.7OSl-E/  
 EF, 5.7OXl-E/EF, 5.7GIl-F, 5.7GXl-G, 8.1GIl-G/GF,  
 8.1GXl-F/FF, 8.1OSl-C/CF, 8.1GIl-G, 8.1GXl-F, DPH-A,  
 DPH-B, DPR-A, DPH-B, EF drives, SX-M TSKs 1998-  
 05, SX-M, DP-SM, (WT drives, PJX-C, PJX-S SX-M,  
 -MACLT, -MDA, -MDB, -MHP, -MTD, DP-E, DP-S, -S1,  
 -S2, DP-SM, -SM)XDP-B



**18-5704**  
**POWER TRIM RELAY**  
 Replaces: 876037  
 20 Amps Resistive  
 15 Amps Inductive  
 Single Pull 5 Terminal  
 For: AQ270, 280



PKG. OF 5

**18-6951**  
**18-6951-9**<sup>②</sup>  
**POWER TILT FUSE**  
**(30 Amp)**  
 Replaces: 851120

① Items ending in "D" are Display Packaged - Regular number is Non-Display

② Priced per package



**18-6770  
TILT/TRIM  
PUMP**

Replaces: 854346  
Oildyne  
For: Early Version SX Drive with 2.5" bolt centers and fine threads



**18-6806  
TRIM PUMP ASSEMBLY**

Replaces: 3587079, 3857489, 3860879  
For: SX - Late Model with Coarse Thread



**18-6822  
TRIM PUMP**

Replaces: Volvo Penta 852928, 820545, OMC 172543, 382715



**18-6804  
TRIM MOTOR**

Replaces: 3861575  
For: SX Drives - Later Version / 2.3" Bolt Centers w/ Coarse Thread



**18-6805  
TRIM MOTOR**

Replaces: 3858071  
For: SX - Early Version / Fine thread & 2.5" bolt centers



**18-6817  
TRIM MOTOR**

Replaces: 854525-3  
Fits: Late model Volvo Penta



**18-6838  
TRIM MOTOR**

Replaces: 3586765, 852928, 872449, 873051  
Fits: DP, DPX Drives



**18-6881  
TRIM MOTOR**

Replaces: Volvo 852928, 872449, 873051,  
Fits: DP, DPX Drives



**18-6823  
WIRING HARNESS**

Replaces: Universal  
Converts 3-wire Tilt and Trim motors to 2-Wire design



**18-6274  
TILT/TRIM MOTOR**

Replaces: 852928, 3857265  
Replaces: Prestolite HYK4001  
Includes Hydraulic Valve Body



**18-6758  
TILT/TRIM MOTOR**

Replaces: 850834  
Electrolux KP5024/120



**18-6779  
TRIM MOTOR**

Replaces: 986280, 3853945  
For: PJX, SX, DPS, DP, DPX, 3.0L GS, GL, 4.3L GL, GS, GI, 5.0L FL, FI, 5.7L GL, GI, 5.8L FL, FI, FSI



**18-6790  
TILT MOTOR**

Replaces: 839430, Electrolux KS3448/290  
Fits: Older model Volvo



**18-6791  
TILT MOTOR**

Replaces: 850046, 853520  
Fits: Older model Volvo



**18-6792  
TILT MOTOR**

Replaces: 897720, 854329  
Fits: Older model Volvo



**18-7627**  
**INTAKE MANIFOLD**

Small-block GM with vortec cylinder heads



**18-7628**  
**INTAKE MANIFOLD**

Small-block GM with vortec cylinder heads with brass lined water jackets



**18-7641**  
**CARBURETOR**  
**(Remanufactured)**

Replaces: 841047-4, 841313-0, 3856393  
AQ225B,C,D,E,F; 225A,B; AQ260A,B; 290A; BB225A,AV,  
BB225B,C; 260A,AV,B,C; 501A, 501A/MS4A; 570/MS4A



**18-7000**  
**CARB KIT**

Replaces: 841836-0, 841292  
SOLEX DOWN DRAFT  
(856471 + 856472 = 18-7000)



**18-7001**  
**CARB KIT**

Replaces: 841293-4  
SOLEX SIDE DRAFT



**18-7008**  
**CARB KIT**



**18-7040**  
**CARB KIT**

Contains adjustable needle & seats



**18-7072**  
**CARB KIT**

Replaces: 855889



**18-7085**  
**CARB KIT**  
Replaces: 875407



**18-7086**  
**CARB KIT**  
Replaces: 841994

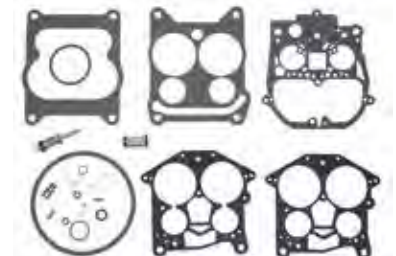

**18-7095**  
**CARB KIT**  
Replaces: 834985-4



**18-7237  
CARB KIT**

**18-7238  
CARB KIT**  
Replaces: 3854020  
For: 4.3L GL, GS, 5.0L GL, 5.7L GL



**18-7241  
CARB KIT**  
Replaces: 3855017  
For: 7.4L GL, 8.2L GL



**18-7242  
CARB KIT**  
Replaces: 3854105



**18-7244  
CARB KIT**  
Replaces: 3854106



**18-7245  
CARB KIT**  
Replaces: 3854107



**18-7246  
CARB KIT**  
Replaces: 3854116  
For: 3.0L GLM, GLP, GSM, GSP, GS, GL



**18-7099  
CARB GASKET SET**  
Replaces: 824803, 856470



**18-7200  
FLOAT**  
Replaces: 841634-9  
(ALCOHOL RESISTANT)  
Brass



**18-7201  
FLOAT**  
(ALCOHOL RESISTANT)  
Brass



**18-7202  
FLOAT**  
(ALCOHOL RESISTANT)  
Brass

**CARBURETOR KIT/FLOAT/CARBURETOR GASKET KIT APPLICATION**

Model	Cyl.	Mfg Code	Carb Model	Carburetor #	Carb Kit ①	Carb Float	Carb Gasket Kit
AQ115A,B,125A,B,130C,D, AQ131A,B,C,D,145A,B AQ151A,B,C,171A,C BB115B,C,145A	4	—	—	SOLEX 44 PA1	18-7000	—	18-7099
AQ120B,140A,BB140A	4	—	—	SOLEX 44 PHN-3	18-7001	—	—
AQ80	4	—	—	ZENITH 34VN	18-7008	—	—
AQ95,95A,100,105A,110, 115 W/109", (1780cc) Dual Carb. Installation	4	ZS-1	150CD	150CD-SE (C1865F,R, C304D,F,R)	18-7085	—	—
AQ120, AQ130A,B,BB115A,w. 121" (1986cc) Dual Carb. Installation	4	ZS-1	175CD	175CD-2S, (C3098F,R, C3200 F,R,C,3231 F,R)	18-7085	—	—
3.0L GL,GS	4	H-2	2300	R-80316A,R-80316-1A	18-7246	—	—
AQ170A,B,C,BB170A,B,C	6	—	—	SOLEX 44 PA1	18-7000	—	18-7099
AQ165A,BB165A (3 Carb. Installation)	6	ZS-1	175CD	175CD-2S, (C3201F,M, R,C 3232F,M,R)	18-7085	—	—
AQ175A	6	R-2	2GE	17059059	18-7086	18-7200	—
4.3L GL,GS	6	H-2	2300	R-80312A,R-80312-1A	18-7238	—	—
4.3L GL,GS	6	H-4	4160	R-80403A,R-80403-1A	18-7237	—	—
AQ200D,F and 500A AQ225B,C,D,E,F,255A,B, AQ260A,B,290A,BB225A,AV, BB225B,C,260A,AV,B,C 501A,501A/MS4A,570/MS4A	8	R-2	2GE	17057133, 17059059	18-7086	18-7200	—
305" (5.0L),307" (5.0L),350" (5.7),	8	R-4	4ME, 4MC, 4MV	17059283,296, 298 7044288,7044289, 1705,628717,057,290	18-7095 18-7072	18-7201	—
5.0L, 5.8L (Fi, FL,SX) (Ford)	8	H-2	2300	R-80382A,R-80382-1A	18-7244	—	—
5.0L, 5.8L (Fi, FL) (Ford)	8	H-4	4150	R-80383A,R-80383-1A	18-7245	—	—
740A/MS5A	8	H-4	4011	R84026AA	18-7040	—	—
454" (7.4L)	8	R-4	4MC, 4MV	7044288,7044289, 1705,628717,057,290	18-7072	18-7201	—
7.4L GL	8	H-4	4150	R-80378A,R-80378-1A	18-7242	—	—
8.2L GL	8	H-4	4150	R-80378A,R-80378-1A	18-7242	—	—

① Does not include metering rods



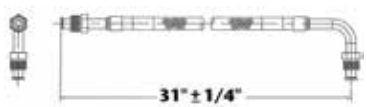

**18-8114  
FUEL LINE HOSE**

For fuel pump to carburetor connection. Replaces copper or steel tubing 3/8" X 31" PTFE composite hose with 5/8"-18 male inverted flare straight one end, 5/8"-18 90° one end. SAE J1527 type A1

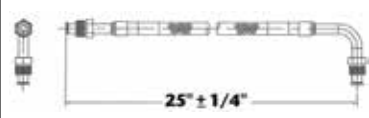

**18-8115  
FUEL LINE HOSE**

For fuel pump to carburetor connection. Replaces copper or steel tubing 3/8" X 25" PTFE composite hose with 5/8"-18 male inverted flare straight one end, 5/8"-18 90° one end. SAE J1527 type A1



**18-7326  
ELECTRIC FUEL PUMP**

Replaces: 3850809, 3858261, 3854620, 3857986



**18-7330  
ELECTRIC FUEL PUMP**

Replaces: 3857650, 3855958



**18-7331  
ELECTRIC FUEL PUMP**

Replaces: 3850810, 3857985, 3858714

**ELECTRIC FUEL PUMP APPLICATION**

Year	Engine	Application	OE #	#'s Superseded from	Part #
1994-99	262/4.3L (HU-WT)	High Pressure pump	3857650		18-7330
1994-99	262/4.3L GL/GS (All)	Carbureted - Low Pressure	3858261	3850809	18-7326
1994-99	262/4.3L GI (HU-WT)	W.Elec. Pump - Low Pressure	3858261	3850809	18-7326
1994-99	454/7.4L & 502/8.2L (HU-WT)	Low pressure system	3858714	3850810, 3857985	18-7331
1993-99	350/5.7L, 454/7.4L, & 502/8.2L	Engines w/MPI - High Pressure	3857650		18-7330
1996-99	454/7.4L & 502/8.2L (HU-WT)	Engines w/MPI - High Pressure	3857650		18-7330
1994-99	5.0L thru 5.8L	Low pressure electric fuel pump	3858261	3850809	18-7326
1994-99	454/7.4L & 502/8.2L (HU-WT)	GM Mark V Eng. - Low Pressure	3858714	3850810, 3857985	18-7331
1992-93	454/7.4L	GM Mark V Eng. - Low Pressure	3858714	3850810, 3857985	18-7331



**18-7268  
FUEL PUMP**

Replaces: 3855276  
For: 5.7L Liter Engines  
Dual Diaphragm requires sight glass



**18-7281  
FUEL PUMP**

Replaces: 826493  
For: GM (V-8) 305, 350



**18-7286  
FUEL PUMP**

Replaces: 841161  
For: XP stamped steel pump  
AQ120B (spec# 867465), AQ125A/B, AQ131A/B/C/D, AQ140A (spec# 867464), BB140A, AQ145A, BB145A, AQ151A/B/C, AQ171A/C, AQ230A/B, AQ250A/B, AQ251A

**18-7783  
FUEL PUMP GASKET SET**

Replaces: 273663  
Fits: D30, D31, D32, D40, D42, D44, AD30A, AQAD30A, TAMD30A, TMD30A, AD31A, AD31B, AD31D, AD31XD, AQAD31A, MD31A, TAMD31A, TAMD31B, TAMD31D, TMD31A, TMD31B, TMD31D, KAD32P-A, AD40B, AQAD40A, AQAD40B, AQD40A, MD40A, TAMD40A, TAMD40B, TMD40A, TMD40B, TMD40C, AD41A, AD41B, AD41D, AQAD41A, D41A, D41B, D41D, TAMD41A, TAMD41B, TAMD41D, TMD41A, TMD41B, TMD41D, KAD42A, KAD42B, KAD42P-A, KAMD42A, KAMD42B, KAMD42P-A, TAMD42B, TAMD42WJ-A, KAD43P-A, KAMD43P-A, KAD44P-A, KAMD44P-A



**18-7229  
FLAME ARRESTOR**

Replaces: 3854026  
For: 3.0L GS, GL, 4.3L GL, GS, GSI, 5.0L FL, FI, 5.7L GL, GI, 5.8L FL, FI, FSI

- UNIVERSAL DESIGN -

## FUEL WATER SEPARATOR BRACKETS



Bracket Type	Part #	Bracket Type	Part #
1/4" Stainless Steel	18-7777	1/4" Aluminum	18-7853-1
3/8" Stainless Steel	18-7776	3/8" Aluminum	18-7775

## FUEL WATER SEPARATOR KITS



### 21 MICRON FILTER KITS - FOR CARBURETED ENGINES

Kit Type	Part #	Micron Rating	Contents
1/4" Aluminum (Short Filter)	18-7848-1	21	1 - 18-7844 filter & 1 18-7853-1 bracket 2 - 18-4256 1/4" pipe plugs
1/4" Aluminum Bonus Pack <b>Contains spare filter</b>	18-7848-2	21	2 - 18-7844 filter & 1 18-7853-1 bracket 2 - 18-4256 1/4" pipe plugs
1/4" Aluminum (Tall Filter)	18-7852-1	21	1 - 18-7845 filter & 1 18-7853-1 bracket 2 - 18-4256 1/4" pipe plugs
1/4" Aluminum Bonus Pack <b>Contains spare filter</b>	18-7852-2	21	2 - 18-7845 filter & 1 18-7853-1 bracket 2 - 18-4256 1/4" pipe plugs
3/8" Aluminum (Tall Filter)	18-7775-1	21	1 - 18-7845 filter & 1 18-7775 bracket 2 - 18-4264 3/8" pipe plugs
1/4" Stainless Steel (Tall Filter)	18-7777-1	21	1 - 18-7845 filter & 1 18-7777 bracket 2 - 18-4256 1/4" pipe plugs
3/8" Stainless Steel (Tall Filter)	18-7776-1	21	1 - 18-7845 filter & 1 18-7776 bracket 2 - 18-4264 3/8" pipe plugs



### 10 MICRON FILTER KITS FOR FUEL INJECTED ENGINES

Kit Type	Part #	Micron Rating	Contents
1/4" Aluminum (Short Filter)	18-7983-1	10	1 - 18-7944 filter & 1 18-7853-1 bracket 2 - 18-4256 1/4" pipe plugs
1/4" Aluminum Bonus Pack <b>Contains spare filter</b>	18-7983-2	10	2 - 18-7944 filter & 1 18-7853-1 bracket 2 - 18-4256 1/4" pipe plugs
1/4" Aluminum (Tall Filter)	18-7982-1	10	1 - 18-7945 filter & 1 18-7853-1 bracket 2 - 18-4256 1/4" pipe plugs
1/4" Aluminum Bonus Pack <b>Contains spare filter</b>	18-7982-2	10	2 - 18-7945 filter & 1 18-7853-1 bracket 2 - 18-4256 1/4" pipe plugs
1/4" Aluminum (High Capacity Filter)	18-7966-1	10	1 - 18-7866 filter & 1 18-7853-1 bracket 2 - 18-4256 1/4" pipe plugs
3/8" Aluminum (Tall Filter)	18-7986-1	10	1 - 18-7945 filter & 1 18-7775 bracket 2 - 18-4264 3/8" pipe plugs
1/4" Stainless Steel (Tall Filter)	18-7984-1	10	1 - 18-7945 filter & 1 18-7777 bracket 2 - 18-4256 1/4" pipe plugs
3/8" Stainless Steel (Tall Filter)	18-7985-1	10	1 - 18-7945 filter & 1 18-7776 bracket 2 - 18-4264 3/8" pipe plugs



**10 MICRON FILTER KITS WITH DRAIN BOWLS**



Sierra AquaVue™ and metal bowl separator filters allow water to be drained from the filter to extend service life. Use the AquaVue™ bowl for outboard, above deck installations. USCG regulations require the use of the flame resistant metal bowl below deck.

Kit Type	Part #	Micron Rating	Contents
1/4" Aluminum w/ metal drain bowl	18-7951	10	1 - 18-7919 filter & 1 18-7853-1 bracket 1 - 18-7924 metal bowl 2 - 18-4256 1/4" pipe plugs
1/4" Stainless Steel w/ metal drain bowl	18-7938	10	1 - 18-7919 filter & 1 18-7777 bracket 1 - 18-7924 metal bowl 2 - 18-4256 1/4" pipe plugs

**VOLVO STYLE BRACKETS AND SEPARATOR KITS**

 <p><b>18-7778 VOLVO ALUMINUM REPLACEMENT BRACKET</b> Replaces: 3850861</p>	 <p><b>18-7990-1 21 MICRON SEPARATOR KIT</b> Contains: 1 - 18-7778 bracket 1 - 18-7789 filter</p>	 <p><b>18-7991-1 10 MICRON SEPARATOR KIT</b> Contains: 1 - 18-7778 bracket 1 - 18-7989 filter</p>
--	---	--

**COMPACT BRACKET AND SEPARATOR KIT -  
FOR SMALL OUTBOARDS AND FRESH WATER APPLICATIONS**

 <p><b>18-7774 COMPACT ALUMINUM BRACKET</b></p>	 <p><b>18-7965-1 10 MICRON COMPACT SEPARATOR KIT</b> Contains: 1 - 18-7774 bracket 1 - 18-7865 filter</p>
--	--

**REPLACEMENT FILTERS**



**UNIVERSAL DESIGN**

10 MICRON REPLACEMENT FILTERS			21 MICRON REPLACEMENT FILTERS		
Part #	Description		Part #	Description	
18-7944	Short - 3.875"		18-7844	Short - 3.875"	
18-7945	Long - 4.35"			Long - 4.35"	
18-7866	High Capacity - 6"			18-7845	Short - 3.875"
18-7865	Compact 10 Micron		Long - 4.35"		

**REPLACEMENT FILTERS FOR VOLVO**

10 MICRON REPLACEMENT FILTERS			21 MICRON REPLACEMENT FILTERS		
Part #	Description	Replaces	Part #	Description	Replaces
18-7946	OMC thread		18-7846	OMC thread	
18-7989	Volvo SX/EFI Cobra EFI	Volvo 3851218-2, 3852413, 3862228	18-7789	Volvo SX/EFI Cobra EFI	Volvo 3851218-2, 3852413



**10 MICRON REPLACEMENT FILTERS AND KITS WITH DRAIN BOWLS**

REPLACEMENT FILTERS			REPLACEMENT BOWLS	
Part #	Description	Replaces	Part #	Description
18-7919	Spin on replacement	Racor S3213	18-7924	Metal Collection Bowl
18-7920	Spin on replacement	Racor S3214		
18-7947	Spin on replacement Fits - 120RRAC01	Racor S3240	FILTER & BOWL KITS	
18-7948	Spin on replacement Fits - 320RRAC01	Racor S3227	Part #	Description
18-7949	Spin on replacement Fits - 660RRAC02	Racor S3232	18-7929	Filter & Metal Bowl Contains: 18-7919 filter, 18-7924 bowl

**18-8125 DIESEL FUEL FILTER**

Replaces: 3583443  
 D4-180i-B, D4-180i-C, D4-210A-A, D4-210A-B, D4-210i-A, D4-210i-B, D4-225A-B, D4-225A-C, D4-225i-B, D4-225i-C, D4-260A-A, D4-260A-B, D4-260A-C, D4-260D-B, D4-260D-C, D4-260i-A, D4-260i-B, D4-260i-C, D4-300A-A, D4-300A-C, D4-300D-A, D4-300D-C, D4-300i-A, D4-300i-C, D6-280A-A, D6-280A-B, D6-280i-A, D6-280i-B, D6-310A-A, D6-310A-B, D6-310D-A, D6-310D-B, D6-310i-A, D6-310i-B, D6-330A-B, D6-330A-C, D6-330D-B, D6-330D-C, D6-330i-B, D6-330i-C, D6-350A-A, D6-350A-B, D6-370A-B, D6-370A-C, D6-370D-A, D6-370D-B, D6-370i-A, D6-370i-B, D6-370i-C, D6-435D-A, D6-435D-C, D6-435i-A, D6-435i-C



**18-8126 DIESEL FUEL FILTER**

Replaces: 861477  
 D1-13 A, D1-13 B, D1-20 A, D1-20 B, D1-30 A, D1-30 B, D2-40 A, D2-40 B, D2-55 A, D2-55 B, D2-55 C, D2-55 D, D2-55 E, D2-55F, D2-75 A, D2-75 B, D2-75 C, D2-75F, MD2010A, MD2010B, MD2020A, MD2020B, MD2030A, MD2030B, MD2040A, MD2040B



**18-7940 FUEL FILTER**

Replaces: 838593, 3588378, 860874  
 KAD32P, TAMD42WJ, KAD43P/44P/300, KAMD43P/44P/300, KAMD42A, KAD42A, KAMD42P, KAD42P, MD22L-A, MD22A-A, TMD22A-A, MD22L-B, MD22P-B, TMD22-B, TMD22P-C, TAMD22P-B, TAMD42B, KAMD42B, KAD42B, TMD31L, TAMD31P/L/M/S, AD31P/L, TMD41L, TAMD41P/L/M/H, TMD41B, TAMD41B, D41B, AD41B (SN 2204141573 & Up), TMD41D, TAMD41D, D41D, AD41D, D41 (SN 2204141572 & Below), MD40, TMD40, TAMD40, AQAD40, KAD32P, TAMD42WJ, KAD43P/44P/300, KAMD43P/44P/300



**18-7858 FUEL FILTER For CAV Type Unit**

Replaces: 858201  
 AQ120B, 125A, B, 131A, 140A, 145A,B, 151, BB, 140, 145A



**18-7862 FUEL FILTER ELEMENT (Includes Gasket)**

Replaces: 841162



**18-8149 HIGH CAPACITY FUEL WATER SEPARATING FILTER**

Replaces: Volvo 3847644  
 Fits most gasoline applications with electric fuel pump. (some height restrictions may occur when using with 18-7778, Volvo 3850861)

**18-7942 FUEL FILTER**

Replaces: 466987, 3825133  
 For: MD100A, TMD100A, MD100B, MD120A, TMD120A, TAMD120A, MD120B, TMD120B, TAMD120B, MD70B, TMD70B, TAMD70B, THAM-D70B, AQAD70B, MD70C, TMD70C, TAMD70C, AQD70C, TAMD60A, TAMD60B, TAMD60C, D5/D7 MARINE GENSET, D5A-T, D5A-TA, D7A-T, D7A-TA, D7C-TA, D63 MARINE, D71/73 MARINE, KAD32P, TAMD42WJ, KAD43P/44P/300, KAMD43P/44P/300, TAMD103A, TAMD61A, TAMD62A, TAMD71A, TAMD72A, TAMD72P, TAMD72WJ, TAMD74, TAMD75 MARINE, TMD102A, TAMD102A, TAMD102D, TMD122A, TAMD122A, TAMD122P, TMD31L, TAMD31P/L/M/S, AD31P/L, TMD41L, TAMD41P/L/M/H



**18-7709 FUEL FILTER**

Replaces: 3840335  
 Fits: KAD42P-A, KAMD42P-1, KAD44P-B, KAD44P-C, KAMD44P-A, KAMD44P-B, KAMD44P-C, TAMD42WJ-A, KAD43P-A, KAMD43P-A, KAT44P-C, KAD300-A, KAMD300-A, MD6A, MD6B, MD7A, MD7B, D41L-A, TAMD41H-B, TMD41L-A, AD41L-A, AD41P-A, TAMD41H-A, TAMD41P-A, MD22A, MD22A-A, MD22L-A, TMD22A, TMD22-A, D3-110i-A, D3-130A-A, D3-130i-A, D3-160A-A, D3-160i-A, D3-110i-B, D3-110i-C, D3-130A-B, D3-130i-B, D3-130A-C, D3-130i-C, D3-160A-B, D3-160i-B, D30160A-B, D3-160A-C, D3-160i-C, D3-190A-B, D3-190i-B, D3-190A-C, D3-190i-C, KKAD42A, KAMD42A, AD41D, D41D, TAMD41D, TMD41D, MD22L-B, MD22P-B, TMD22-B, TMD22P-C, TAMD22P-B



**18-7859 FUEL FILTER**

Replaces: 835576  
 For: AQ175, 200, 226, 266, 290, BB200, 225, 260



**18-8124 DIESEL FUEL FILTER**

Replaces: 829913  
 Fits: 2001, 2001B, 2002, 2002B, 2003, 2003B/T/B, AQD2B, MD11C/D, MD17C/D, MD1B, MD2B, MD3B, MD5A/B/C, MD7/B





**18-7792  
FUEL FILTER**  
Replaces: 3855104  
For: Volvo 3.0L (1994-99),  
OMC 3.0L (1995-98)



**18-7964  
TRANSMISSION  
FILTER KIT**  
For: Mercruiser V-8 Inboard  
with Hurth Transmission



**18-7717  
FILTER ELEMENT**  
For: Rochester 2 bbl &  
4 bbl Carburetors



**18-79007  
AIR FILTER**  
Replaces: 3825038  
Fits: TAMD63L-1, TAMD63P-A



**18-7689  
FUEL INJECTOR**  
Replaces: 3855182  
Fits: 5.7GLPMDA, 5.7GIPMDA, 5.7GIPMDACE, 5.7GLIM-  
DA, 5.7GIIMDA, 4.3GLPHUB, 4.3GSPHUB, 4.3GSPHUS,  
4.3GIPHUSCE, 5.7GIPHUS, 4.3GLPNCA, 4.3GLPNCB,  
4.3GLPNCS, 4.3GSJNCC, 4.3GSJNCS, 4.3GSPNCA,  
4.3GSPNCB, 4.3GSPNCM, 4.3GSPNCS, 4.3GIPNCA,  
4.3GIPNCBCE, 4.3, 5.7GLPNCS, 5.7GIPNCA,  
5.7GIPNCSC, 5.7GIPNCMCE, 5.7GIPNCBCE,  
5.7GIINCCCE, 5.7GIINCSCE, 4.3GLPLKD, 4.3GLPLKE,  
4.3GSPDK, 4.3GSPLKE, 4.3GIPLKDC, 4.3GIPLKECE,  
4.3GSJLKD, 4.3GLPLKA, 5.7GLPLKD, 5.7GLPLKE,  
5.7GLPLKR, 5.7GSPDK, 5.7GSPLKE, 5.7GIPLKDC,  
5.7GIPLKDC, 5.7GIPLKECE, 5.7GSICPLKD, 5.7GSIPLK,  
4.3GLPBYC, 4.3GSPBYC, 4.3GIPBYCCE, 4.3GSJBYA,  
4.3GIJBYA (1994-07)



**18-7685  
TBI INJECTOR**  
Replaces: 3858941  
Fits: 4.3GXi-A, 4.3GLPWTC, 4.3GLPWTR,  
4.3GSPWTC, 4.3GSPWTR, 4.3GIPWTC,  
4.3GIPWTR, 4.3GIJWTR, 4.3GSJWTR,  
4.3GLPEFS, 4.3GIPEFS



**18-7702  
AIR CHARGE  
TEMPERATURE SENDER**  
Replaces: 3854527  
Fits: 5.0L Gxi-A(2001-02), 5.7L GiL-A  
(2001), 5.7L Gi-A(2000-01), 5.7L GSiL-A  
(2000-01), 5.7L Gxi-A(00-01), 5.7L XiL-A  
(00-01), 5.7L Gxi-B(01-02), Many 7.4L  
(1994-00), Many 8.1L (2005-Current)



**18-7601  
AIR CHARGE  
TEMPERATURE  
SENSOR**  
Replaces: 3854158  
For: 5.0 Fi/5.8 Fi (1994-96) &  
5.0 FL/5.8 FL/5.8 FSi (1995-96)



**18-7647  
TEMPERATURE SENDER**  
Replaces: 872066  
Fits: 4.3GL-A, 4.3GL-B, 4.3GL-C, 4.3GL-D,  
5.7GL-A, 5.7GL-B, 5.7GL-C, 5.7GL-D, 5.7GL-E,  
5.0GL-A, 5.0GL-B, 5.0GL-C, 5.0GL-D, 5.0GL-E,  
3.0GLP-A, 3.0GLP-B, 3.0GLM-A, 3.0GLM-B,  
3.0GSP-A, 3.0GSP-B, 3.0GSP-C, 3.0GSM-A,  
3.0GSM-B, 3.0GSM-C, 3.0GLM-C, 3.0GLP-C,  
3.0GLP-D, 4.3GL-E, 4.3GL-EF, 5.0GL-F, 5.0GL-  
FF, 3.0GLP-E, 4.3GL-G, 4.3GL-GF, 4.3GL-J,  
4.3GL-JF, 5.0GL-H, 5.0GL-HF, 3.0GLP-J,  
3.0GLP-N, 5.0GL-J, 5.0GL-JF (1998-2007)



**18-7513  
TEMPERATURE SENSOR**  
Replaces: 3862500



**18-5897  
TEMPERATURE  
SENDER**  
Replaces: 3853787  
For: 5.0L FL, FI, 5.8L FL, FI, FSi



**18-7700  
THROTTLE  
POSITION SENSOR**  
Replaces: 3857487  
Fits: 4.3, 5.0, 5.7, 8.1, 8.2L models



**18-5899  
OIL PRESSURE SENDER**  
Replaces: 3857532  
For: 230, 250, 3.0L GLM, GLP, GSM,  
GSP, 4.3L GL, GXI, OSI, 5.0L GL, GXI,  
OSI, 5.7L GL, GI, GXI, GIL, GXIL, OSI,  
OSXI, 8.1L GI, GXI, OSI, GIL



**18-7704  
IAC MOTOR**  
Replaces: 3855194  
Fits: 4.3, 5.0, 5.7, 7.4L models



**18-7705  
IAC MOTOR**  
Replaces: 3843751  
Fits: 4.3GXIE-M



**18-7684  
MAP SENSOR**  
Replaces: 3850396  
Fits: 4.3, 5.0, 5.7, 7.4L models  
(1994-2007)



**18-7677  
KNOCK SENSOR**  
Replaces: 3850357  
Fits: 4.3, 5.0, 5.7L models (2002-07)



**18-7703  
KNOCK SENSOR**  
Replaces: 3854512  
Fits: 7.4, 8.2L (1999-2001)



**18-7679  
KNOCK SENSOR**  
Replaces: 3854905  
Fits: 4.3L (1994-2002), 5.0L Gxi-A  
(2001-02), 5.7L GiL-A(2001), 5.7Gi-A,  
5.7GXi-A, 5.7GXi-B, 5.7GiL-A, 5.7GSiL-A,  
5.7GXiL, 5.7GXiL-B(2000-03), 5.7GLPNCS,  
5.7GIPNCA, 5.7GIPNCSC, 5.7GIPNCSC,  
5.7GIPNCMCE, 5.7GIPNCBCE,  
5.7GIINCCCE, 5.7GIINCSCE(1995-96)



**18-7888  
DRAIN PLUG  
& GASKET**  
Replaces: 826648, 862293  
For CAV Filter

PKG OF 10



**SNAPPER CLAMPS**

Part #	Range	Size
<b>18-8200</b> ①	.360 - .406	2
<b>18-8201</b> ①	.410 - .468	4
<b>18-8202</b> ①	.475 - .536	6
<b>18-8020</b> ①	.538 - .608	8
<b>18-8021</b> ①	.597 - .665	10
<b>18-8034</b> ①	.670 - .780	12
<b>18-8203</b> ①	.750 - .875	14
<b>18-8204</b> ①	.875 - .975	19



**18-3575  
CIRCULATING  
WATER PUMP**  
Replaces: 3854017  
Fits: 3.0L 4 cyl. engines  
**(Bi-Directional)**



**18-3577  
CIRCULATING WATER PUMP**  
Replaces: 3855991, 856609  
**(Bi-Directional)**



**18-3583  
CIRCULATING WATER PUMP**  
Replaces: 835390, 856364, 3853850  
Fits: 4.3, 5.0, 5.7 engines  
**(Bi-Directional)**



**18-3584  
CIRCULATING WATER PUMP**  
Replaces: 3853796  
For Ford 5.0 and 5.8  
**(Bi-Directional)**



**18-3599  
CIRCULATING WATER PUMP**  
Replaces: 3853850  
For late model GM V-6 & V-8 engines  
using a composite timing cover



**18-3586  
WATER PUMP**  
Replaces: 841640  
**(Crank Shaft Mounted)**  
Fits: 431A, 500A/B, 501A, 570A, 571A, AQ180, AQ200,  
AQ200B/C/D/F, AQ250A, AQ211A, AQ225, AQ231A/B,  
AQ260, AQ255B, AQ260A, AQ271A/B/C/D/, AQ280A,  
AQ290A



**18-0368  
WATER CIRCULATING  
PUMP GASKET SET**  
Fits: B21, B23, AQ120B, AQ125A, AQ140A, BB140A,  
AQ145A, BB145A



**18-2779  
EXHAUST HOSE**  
Replaces: 3852696  
For: 4.3L GL, GS, GI, GXI, OSI, 5.0L FI, GL, FL,  
GXI, OSI, 5.7L GL, GI, GIL, OSI, GXI, OSXI, 5.8L  
FL, FI, FSI, 7.4L GL, GI, 8.1L GI, GXI, OSI, 8.2L GL



**18-2780-1  
HOSE**  
Replaces: 3852741, 3863450  
For: 3.0L GL, GS, GI, GLM, GLP, GSM, GSP, GS,  
4.3L GL, GS, GI, GXI, OSI, 5.0L FL, FI, GL, GXI,  
OSI, 5.7L GL, GI, GXI, OSI, OSXI, GIL, GXIL, 5.8L  
FL, FI, FSI, 7.4L GL, GI, GSI, 8.2L GSI



**18-2781  
EXHAUST HOSE**  
Replaces: 3852742  
For: 5.0L FL, GL, GXI, OSI, 5.7L GL, GI, GXI,  
GIL, GXIL, OSI, OSXI, 5.8L FL, FSI, 7.4L GL,  
GI, GSI, 8.1L, 8.2L GL, GSI



**18-3106  
WATER PUMP COUPLER**  
Replaces: 806256, 831009  
AQ90, 95, 100, 110, 120A, 115, 130,  
MB3B, 17C, D

**18-3175  
WATER PUMP COUPLER**  
Replaces: 858467  
Fits: D31, D32, D41, D42, D43, D44, D300, AD31A, AD31B, AD31D, AD31L-A,  
AD31P-A, AD31XD, AQAD31A, MD31A, TAMD31A, TAMD31B, TAMD31D, TAMD31L-  
A, TAMD31M-A, TAMD31P-A, TMD31A, TMD31B, TMD31D, TMDL-A, KAD32P-A,  
AD41A, AD41B, AD41D, AD41L-A, AD41P-A, AQAD41A, D41A, D41B, D41D, D41L-A,  
TAMD41A, TAMD41B, TAMD41D, TAMD41H-A, TAMD41L-A, TAMD41M-A,  
TAMD41P-A, TMD41A, TMD41B, TMD41D, TMD41L-A, KAD42A, KAD42B, KAD42P-A,  
TAMD42B, TAMD42WJ-A, KAD43P-A, KAMD43P-A, KAD44P-A, KAD44P-B, KAD44P-  
C, KAMD44P-A, KAMD44P-B, KAMD44P-C, KAD300A, KAMD300A



① This product is priced per piece. To order priced per package, please add -9 to the part number.



**18-3274**  
**IMPELLER KEY**  
Replaces: 808007  
MD21B, AQD21B, 230A/SP-A/  
MT, 230A, 230B, 250A, 250B,  
AQ125B, AQ145B, AQ131A,  
AQ151, AQ151A, AQ151B,  
AQ151C, AQ171, AQ171A,  
AQ171C, 251A



**18-3275**  
**IMPELLER KIT**  
Volvo 877066  
Fits: TAMD74A, A-A, A-B (2000-2005); TAMD74C-A, C-B (2000-2005); TAMD74L-A, B (1999-2005); TAMD74P-A, P-B (1998-2005); TAMD75P-A (1998-2005); TAMD71B (1989-2000); TAMD73P-A (1997-1998); TAMD73WJ-A (1997-1999).



**18-3504**  
**IMPELLER KIT**  
Volvo 3588475  
Fits: D4-180I-B, D4-180I-C, D4-180I-D, D4-210A-A, D4-210A-B, D4-210I-A, D4-210I-B, D4-225A-B, D4-225A-C, D4-225A-D, D4-225I-B, D4-225I-C, D4-225I-D, D4-260A-A, D4-260A-B, D4-260A-C, D4-260A-D, D4-260D-B, D4-260D-C, D4-260D-D, D4-260I-A, D4-260I-B, D4-260I-C, D4-260I-D, D4-300A-A, D4-300A-C, D4-300A-D, D4-300D-A, D4-300D-C, D4-300D-D, D4-300I-A, D4-300I-C, D4-300I-D



**18-3276-1**  
**IMPELLER KIT**  
Replaces: 3862567, 21213660  
Fits: Volvo (1999 and Later)



**18-3277**  
**IMPELLER KIT**  
Replaces: 3862281, Yanmar  
192470-42530, 192470-42532  
Fits: Volvo (1998 and Earlier),  
Johnson Pump 09-102 BB



**18-3047**  
**IMPELLER KIT**  
Replaces: 835874  
Sherwood 10615K,  
Jabsco 18948-0001  
12 FINS



**18-3060**  
**IMPELLER**  
Replaces: 835512, 3854286  
Sherwood 9959,  
Jabsco 18838-0001  
Oberdorfer 132-0317  
OMC 3854286  
Neoprene, 12 FINS



**18-3046**  
**IMPELLER**  
Replaces: 3854286



**18-3061**  
**IMPELLER**  
Replaces: 835874,  
Sherwood 0615K,  
Jabsco 18948-0001  
Neoprene  
12 FINS  
For: GM engines with V-Belt



**18-3075D** 

**18-3075**  
**IMPELLER KIT**  
Replaces: 875575, Jabsco 2877-0001,  
4568-0001, Johnson 09-801B,  
Oberdorfer B6620  
12 FINS  
Neoprene



**18-3076**  
**IMPELLER KIT**  
Replaces: 875583, 833995  
Jabsco 22405-0001  
Johnson Pump 09-45589,  
09-808B  
6 FINS, Neoprene



**18-3077** **18-3038**  
**(Neoprene) (Nitrile)**  
**WATER PUMP KIT**  
Replaces: 877061-2, 3841697  
For: AQ 30, 31, 40, 41 AQD 19, 27, 29, 32, KAD/KAMD  
42A, B, P, MD, 19, 27, 29, 32, TAMD 60A, B, C



**18-3078** **18-3037**  
**(Neoprene) (Nitrile)**  
**WATER PUMP KIT**  
Replaces: 875736, 875660, 2430184  
Jabsco 836-0003,  
Johnson Pump 09-1029B-9  
For: AQ, AD 40 A, B, TAMD 40 A, B, TAMD 61-62 A, 71-72A



**18-3287**  
**IMPELLER KIT**  
Replaces: 876120  
Fits: 431A, BB231A, 570A, 571A, 572A, 740A, 740B,  
AQ200D, AQ205A, AQ225D, AQ255B, AQ260A, AQ260B,  
AQ271A, AQ271B, AQ271C, AQ271D, AQ280A, AQ290A,  
AQ311A, AQ311B, BB225A, BB225AV, BB225B, BB260A,  
BB260AV, BB261A



**18-3079**  
**IMPELLER KIT**  
Replaces: 875807-0, 3586498  
Johnson Pump 09-806B Sherwood 9979K  
6 FINS  
Neoprene  
Jabsco 4528-0001  
Side Width 3/4" Dia. 1 9/16"



**18-3080**  
**(Neoprene)**  
**WATER PUMP KIT**

Volvo 875808, 3593659  
Jabsco 673-0001  
Johnson Pump 09-1026B-1

For: AQ 60, 80, 90, 95, 100, 105, 110, 115, 120A, 130, B 16, BB 25, 30, 70, 100, MB 18, 20, MD 3B, 17C, D, ND2010B, 2020B, 2030B, 2040BC

**18-3036**  
**(Nitrile)**

Jabsco 673-0003  
Johnson Pump 09-1026B-9

① **18-3081D**

Display Package



**18-3081**  
**IMPELLER KIT**

Replaces: 875811-2,  
3858256, 3862281  
OMC 3858256  
Johnson Pump 09-1027B  
Neoprene  
12 SPLINES 12 FINES  
Jabsco 1210-0001



**18-3089**  
**WATER PUMP KIT**

Replaces: 09-45825  
Johnson Pump  
For 18-3587 Pump

**18-30777**  
**IMPELLER KIT**

Replaces: 3841697

Fits: D70CHC, D70CRC, TD70CHC, TD70 CRC, KAD42P-A, KAD42, KAMD42, KAMD42P-A, DPX, HS1A, DP-D1, DP-E, DP-G, KAD32P, TAMD42WJ-A, KAD43P, KAMD43P, KAD44P, KAMD44P, KAD300, KAMD300, MD100A, TMD100A, MD100B, MD120, TMD120A, TMD120AK, TAMD120A, TAMD120AK, TMD120B, TAMD120B, TAMD120B-CC, TAMD60A, TAMD60B, TMD31L, TAMD31P/L/M/S, AD31P/L, TMD41L, TAMD41P/L/M/H, TAMD60C, MD70B, MD70BK, TMD70B, THAMD70B, TAMD70B, AQD70BL, AQD70B, MD70C, TMD70C, THAMD70C, AQD70C, TAMD70D, AQD70D, TAMD70E, AD30A, AQAD30A, MD30A, TAMD30A, TMD30A, AD30, AQAD30, MD30, TAMD30, TMD30, MD40, TMD40, AQD40, TAMD40, AQAD40, TMD41, D41A, TAMD41, AQAD41A, AD41A, AD41B, 290A, DP-A, DP-B, DP-1A, DP-B1, SP-A, SP-A1, TMD121C, TAMD121C, TAMD121D, TAMD122C, TAMD122D, MD31A, TMD31B, TAMD31B, AD31B, TMD41B, D41B, TAMD41B, AD31B, TMD41B, D41B, TAMD41B, AD41B, KAD42A, KAMD42A, DP-D, MS5B, AD31D, AD31XD, TAMD31D, TMD31D, AD41D, D41D, TAMD41D, TMD41D, DP-D1, DP-E, DP-S, DPX, SP-C1, HS1A, KAD42B, KAMD42B, TAMD42B.



**18-3205**  
**WATER PUMP REPAIR KIT**

Replaces: 875574  
AQ120B, 125A, B, 131A, 140A, 145A, B, 151A, B



**18-3208**  
**WATER PUMP REPAIR KIT**

Replaces: 875584  
MD5A, B, C, MD6B, MD7A, B, MD11C, D



**18-3209**  
**WATER PUMP REPAIR KIT**

Replaces: 875383  
AQ165A, 170A, B, C, MD21A (S/N MD103387 & UP), MD21B



**18-3261**  
**WATER PUMP REPAIR KIT**

Replaces: 875769  
Fits: D40, AD40B, AQAD40A, AQAD40B, TAMD40A, TAMD40B

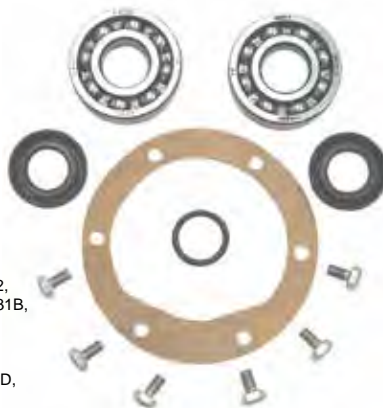

**18-3262**  
**WATER PUMP REPAIR KIT**

Replaces: 875759  
For sea water pumps: Fits: D30, D31, D32, D40, D41, D42, D43, D44, AD30A, AQAD30A, TAMD30A, TMD30A, AD31A, AD31B, AD31D, AD31XD, AQAD31A, MD31A, TAMD31A, TMD31B, TAMD31D, TMD31A, TMD31B, TMD31D, KAD32P-A, AQD40A, MD40A, TMD40A, TMD40B, TMD40C, AD41A, AD41B, AD41D, AQAD41A, D41A, D41B, D41D, TAMD41A, TAMD41B, TAMD41D, TMD41A, TMD41B, TMD41D, KAD42A, KAD42B, KAD42P-A, KAMD42A, KAMD42B, KAMD42P-A, TAMD42B, TAMD42WJ-A, KAD43P-A, KAMD43P-A, KAD44P-A, KAMD44P-A



**18-3263**  
**WATER PUMP REPAIR KIT**

Replaces: 875698  
For sea water pumps: Fits: B18, B20, D3, D17, AQ60F, AQ90, AQ95A, AQ110, AQ120, BB30, BB100, MB18, AQ105A, AQ115A, AQ115B, AQ130A, AQ130B, AQ130C, AQ130D, BB115, BB115B, BB115C, MB20A, MB20B, MB20C, MD3B, MD17C, MD17D,



**SINGLE DIAMETER HOSE**

 <p><b>18-70021</b> MOLDED HOSE 3/4" ID</p> <p>4 3/4"</p>	 <p><b>18-70704</b> MOLDED HOSE 1 1/4" ID</p> <p>5"</p>	
 <p><b>18-70924</b> MOLDED HOSE 1 3/4" ID</p> <p>5"</p>	 <p><b>18-71218</b> MOLDED HOSE 1" ID</p> <p>12 1/2"</p>	 <p><b>18-71337</b> MOLDED HOSE 1 3/4" ID</p> <p>12 3/4"</p>

**STRAIGHT HOSE**

 <p><b>18-75100</b> MOLDED HOSE Straight 48" 1" ID</p>	 <p><b>18-75125</b> MOLDED HOSE Straight 48" 1 1/4" ID</p>
---	---

**V-BELTS**



- 1 High strength synthetic cords resist shockload failure. Their low stretch properties assure uniform performance over the life of the belt.
- 2 The compression section is a special rubber compound that assures smooth and even transfer of load forces to the cords.
- 3 Cogs are molded to precise engineering tolerances to improve flexibility and maintain cord support. Cog geometry provides a large area for air circulation to keep the belt cool and prevent damaging heat build up in the cushion section.
- 4 Rubber edges maintain positive, no-slip contact with pulley grooves for reliable energy transfer.

**BELT SIZE LISTING BY NUMBER**

Part #	Effective Length (Inches)	Top Width (Inches)	Part #	Effective Length (Inches)	Top Width (Inches)	Part #	Effective Length (Inches)	Top Width (Inches)
18-15290	29	29/64	18-15405	40 1/2	29/64	18-15460	46	29/64
18-15300	30	29/64	18-15410	41	29/64	18-15470	47	29/64
18-15325	32 1/2	29/64	18-15415	41 1/2	29/64	18-15480	48	29/64
18-15345	34 1/2	29/64	18-15430	43	29/64	18-15495	49 1/2	29/64
18-15370	37	29/64	18-15435	43 1/2	29/64	18-15500	50	29/64
18-15380	38	29/64	18-15440	44	29/64	18-15520	52	29/64
18-15390	39	29/64	18-15450	45	29/64	18-15550	55	29/64
18-15400	40	29/64	18-15455	45 1/2	29/64			

**V-BELT INTERCHANGE**

Part #	Volvo #	Part #	Volvo #	Volvo #	Part #	Volvo #	Part
18-15325	958303	18-15450	960336	829207	18-15460	# 960336	18-15450
18-15390	958310	18-15450	3858462	841821	18-15430	966382	18-15435
18-15405	958311	18-15455	3852464	950813	18-15410	985357	18-15415
18-15410	950813	18-15460	829207	950818	18-15460	958359-2	18-15435
18-15415	985357	18-15460	950818	952141	18-15500	958498	18-4046
18-4044	966694-2	18-15495	958320	958303	18-15325	966694-2	18-4044
18-15430	841821	18-15500	952141	958310	18-15390	966857	18-4046
18-15435	958314	18-4046	958498	958311	18-15405		
18-15435	958359	18-4046	966857	958314	18-15435		
18-15435	958359-2			958320	18-15495		
18-15435	966382			958359	18-15435		

**HOSE INTERCHANGE**

Part #	Volvo #	Part #	Volvo #	Volvo #	Part #	Volvo #	Part #
18-70704	838513	18-75125	826423	826423	18-75125	845792	18-75125
18-70704	856306	18-75125	845792	838513	18-70704	856306	18-70704

**Fits GM Small Block V8 305-350 cu. in.  
Models AQ & BB 200, 205, 211, 231, 225,  
260, 271, 290, 311, 500, 501, 570, 571 & 572**

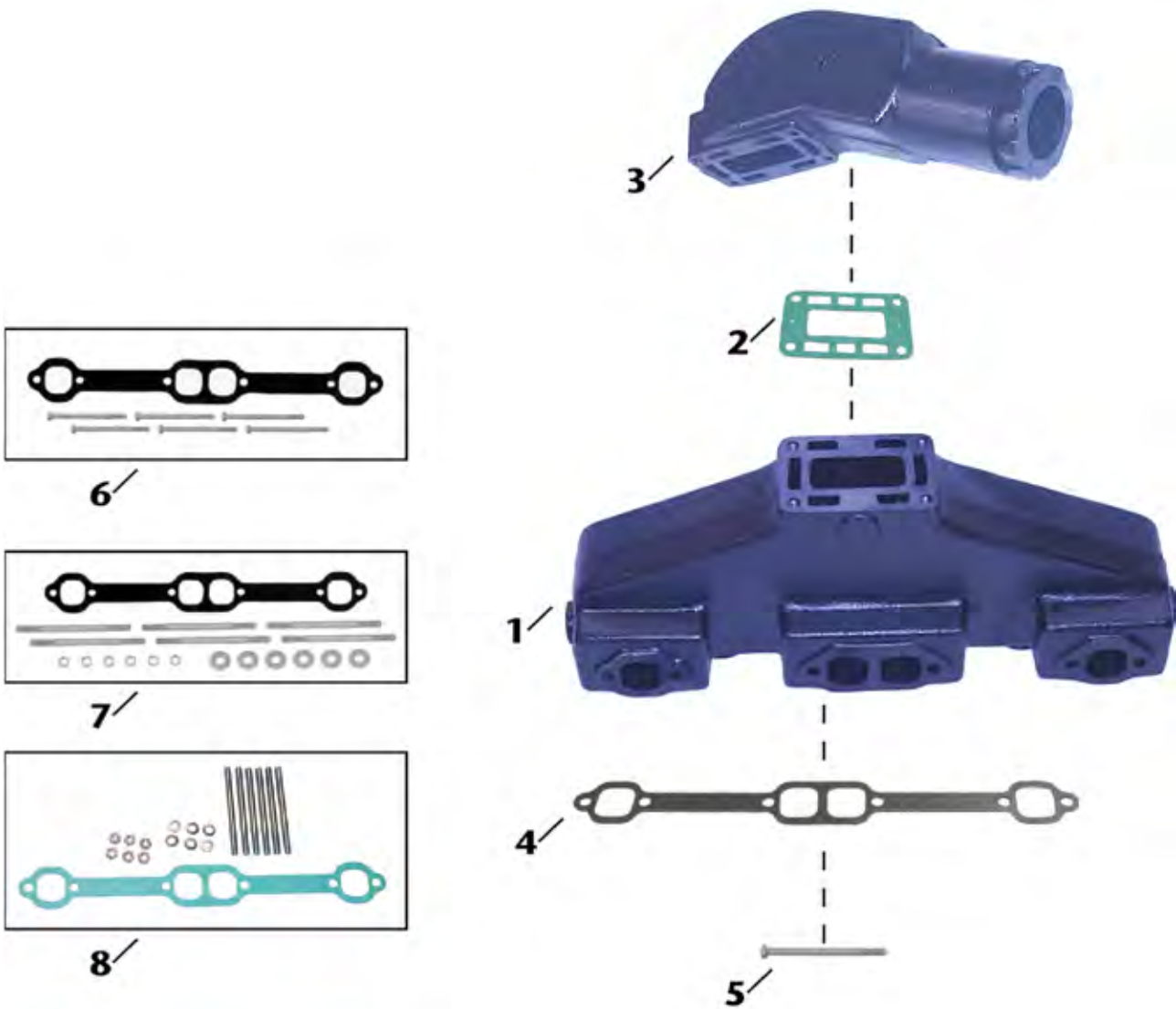

Item No	Description	OE No.	Application
1	18-1931-1 MANIFOLD	835804-6	GM Small Block (V8) 305-350 cu.in. Model AQ & BB 200, 205, 231, 225, 260, 271, 290, 311, 500, 501, 570, 571, & 572. Use with Manifold Gasket: 18-2949; Mounting Kit: 18-8511.
2	18-2971 ELBOW GASKET	856039-3	Use with Manifold: 18-1931-1; Elbow: 18-1935-1
3	18-1935-1 ELBOW	855384-4	Use with Manifold: 18-1931-1; Elbow Gasket: 18-2971.
4	18-2949 MANIFOLD GASKET	N/A	Use with Manifold: 18-1931-1; Included in 18-8511 mounting kit.
5	NSS MOUNTING BOLT	N/A	Included in 18-8511 mounting kit.
6	18-8511 MOUNTING KIT	N/A	Use with Manifold: 18-1931-1.
7	18-8502 MOUNTING KIT	N/A	Use with Manifold: 18-1931-1. Includes mounting studs and hardware.
8	18-8502 MOUNTING KIT	N/A	Use with Manifold: 18-1931-1. Includes mounting studs and hardware.

## Fits GM V6 (1993 & Before) AQ 175, 205, 430A/B, 431, 434

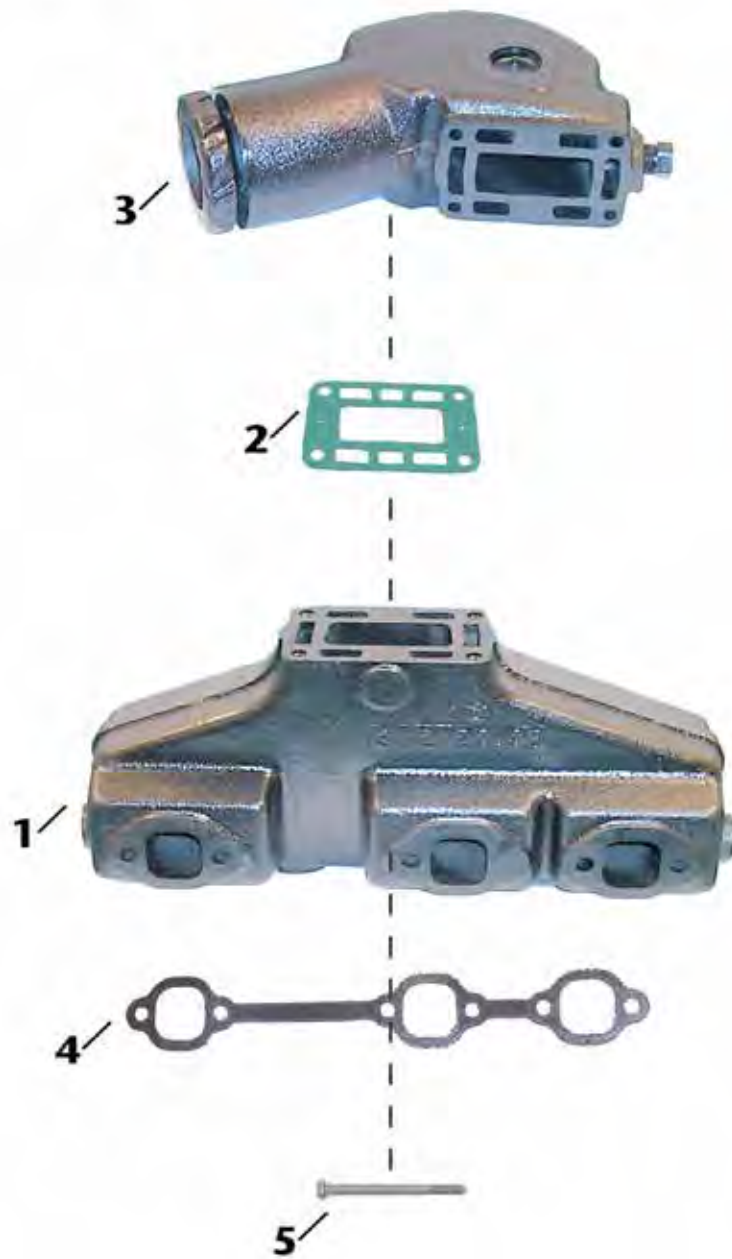

Item No	Description	OE No.	Application
1	18-1932 MANIFOLD	856894-1	GM (V6) (1993 & Before) Model AQ 175, 205, 430 A/B, 432, 434. Use with 18-2909 Manifold Gasket.
2	18-2971 ELBOW GASKET	856039-3	Use with Manifold: 18-1932; Elbow: 18-1936.
3	18-1936 ELBOW	857037-6	Use with Manifold: 18-1932; Elbow Gasket: 18-2971
4	18-2909 MANIFOLD GASKET	N/A	Use with Manifold: 18-1932.
5	NSS MOUNTING BOLT	N/A	Use to secure 18-2909 to 18-1932.

## SIERRA MANIFOLDS ARE PAINTED, PACKAGED AND LEAK TESTED



**18-1848  
MANIFOLD**  
Replaces: 3857656  
Fits: Volvo 4.3L V-6

**18-1898  
MANIFOLD**  
Port & Starboard  
Replaces: Barr CHVA-1-84, Marine Power 0991-110  
Fits 454 cu.in. GM big block V8 engines  
Use with:  
Exhaust Manifold Gasket: 18-0418  
**\*For Exploded View - See Pages 556-557**



**18-1930-1  
MANIFOLD**  
Replaces: 855387, 834438-4  
FITS: Volvo AQ120B, 125A, 140A, 145A, BB140A, 145A  
Supplied with Mounting Package  
Use with:  
Exhaust Manifold Gasket: 18-2991  
Mounting Kit: 18-8539

**18-1931-1  
MANIFOLD**  
Port & Starboard  
Replaces: 835804, 856883  
FITS: Volvo AQ200D, 200F, 225D, 225E, 225F, 255B, 260A, 271A, 280A, 290A, 311A, AQ500, 570: BB225, 225AV, 225B, 260A, 260AV, 260B, 260C  
Supplied with Mounting Package  
Use with:  
Mounting Kit: 18-8511



**18-1986-1  
MANIFOLD**  
Port & Starboard  
Replaces: 3852374-2, 3857723, 3847501  
For: 5.0L & 5.7L GM (New Style)  
Use with:  
Exhaust Manifold Gasket: 18-2949  
Mounting Kit: 18-8502

**18-1932  
MANIFOLD**  
Port & Starboard  
Replaces: 856894  
For: 4.3L Fits: AQ175, AQ430, AQ431A, AQ431B, AQ432, AQ434  
Use with:  
Exhaust Manifold Gasket: 18-2909



**18-1997-1  
MANIFOLD**  
Port & Starboard  
Replaces: Barr CHV-1-83  
Universal Center Riser Manifold  
FITS: GM 283, 305, 307 and 350 CID engines  
Use with:  
Exhaust Manifold Gasket Set: 18-0604  
**\*For Exploded View - See Pages 558-559**

**18-1936  
RISER**  
Replaces: 857037  
For: 4.3L Fits: AQ175, AQ430, AQ431A, AQ431B, AQ432, AQ434  
Use with:  
Riser Gasket: 18-2971

**18-1999**

**ELBOW**

Replaces: Barr 20-0082  
 Comes with 18-4364 Exhaust Elbow Kit (open)  
 If blocked mounting kit is required use 18-8535  
 Replaces: Barr 20-0082-P

Use with:  
 Manifold: 18-1997-1  
 Riser Gasket: 18-2854 open or 18-0476 blocked



**18-1935-1**

**RISER**

Replaces: 855384-4, 856891

Use with:  
 Manifold: 18-1931-1  
 Exhaust Riser Gasket: 18-2971  
 Mounting Kit: 18-8510



**18-1909-1**

**RISER**

Replaces: OMC 913784, 3855270, 3850456,  
 Volvo 3855270-9, 3863061  
 OMC Riser, 4" outlet 7": Fits many GM & Ford center rise manifolds.

Use with:  
 Manifold: 18-1986-1  
 Riser Gasket: 18-0943-1 open  
 Mounting Kit: 18-8507 open



**18-1939**

**RISER**

Replaces: Barr 20-0100, Marine Power 0992-593 Barr, Indmar,  
 and Marine Power Ford Small Block V8 302-351cu.in., GM  
 Small Block V8 305-350cu.in., GM Big Block V8 454cu.in.

Use with:  
 Manifold: 18-1997-1, 18-1998-1  
 Riser Gasket: 18-2854 open or 18-0476 blocked  
 Mounting Kit: 18-4364 open or 18-8535 blocked



**18-1907**

**RISER**

Replaces: Barr 20-0102, Indmar 53-2009, 53-2018 Barr  
 and Indmar Ford Small Block V8 302-351cu.in.

Use with:  
 Manifold: 18-1997-1, 18-1998-1  
 Riser Gasket: 18-2854 open or 18-0476 blocked  
 Mounting Kit: 18-4364 open or 18-8535 blocked



**18-1991**

**ELBOW ADAPTER**

For use with 3" I.D. Exhaust Hose

Use with:  
 Manifold Riser: 18-1999  
 30°



**18-1992-1**

**ELBOW ADAPTER**

For 3" I.D. Exhaust Hose  
 (As used in 18-1987 Exhaust Manifold  
 Conversion Kit)  
 80°



**18-4007**

**EXHAUST ELBOW**

Replaces: 845261  
 Fits: D30, D40, AD30A, AQAD30, TAMD30A, TMD30A,  
 AD40B, AQAD40A, AQAD40B, AQD40A, TAMD40A,  
 TAMD40B, TMD40A, TMD40B, TMD40C



**18-1949**

**MANIFOLD SPACER**

Barr, Indmar and Marine Power Ford Small Block V8  
 302-351cu.in., GM Small Block V8 305-350cu.in., GM Big  
 Block V8 454cu.in.

Used with:  
 Manifolds: 18-1998-1, 18-1997-1,  
 18-1898



**18-4364 (Open)**

**EXHAUST ELBOW KIT**

Replaces: Barr 20-0082-P  
 Use with:  
 Riser: 18-1999, 18-1907, 18-1939





**18-8502**  
**EXHAUST MANIFOLD MOUNTING KIT**  
 OMC GM Small Block V8 305-350cu.in.  
 (1979-89) OMC/Volvo GM Small Block  
 305-350cu.in.  
 Used with:  
 Manifold: 18-1931-1, 18-1902, 18-1903  
 & 18-1986-1



**18-8507**  
**EXHAUST ELBOW MOUNTING KIT**  
 OMC/Volvo GM Small Block V8  
 305-350cu.in.  
 Used with:  
 Riser: 18-1909-1



**18-8510**  
**EXHAUST ELBOW MOUNTING KIT**  
 Volvo GM Small Block V8 305-350cu.in.  
 (Models: AQ and BB200, 205, 211, 231, 225,  
 260, 271, 290, 311, 500, 501, 570, 571, 572)  
 Used with:  
 Riser: 18-1935-1



**18-8511**  
**EXHAUST MANIFOLD MOUNTING KIT**  
 Volvo GM Small Block V8 305-350cu.in.  
 (Models: AQ and BB200, 205, 211, 231,  
 225, 260, 271, 290, 311, 500, 501, 570,  
 571, 572)  
 Used with:  
 Manifold 18-1931-1



**18-8535 (Blocked)**  
**EXHAUST ELBOW MOUNTING KIT**  
 Barr, Indmar and Marine Power Ford Small  
 Block V8 302-351cu.in., GM Small Block V8  
 305-350cu.in., GM Big Block V8 454cu.in.  
 Used with:  
 Riser: 18-1939, 18-1999, and 18-1907



**18-8536**  
**EXHAUST ELBOW MOUNTING KIT**  
 Barr, Indmar and Marine Power  
 GM Small Block V8 305-350cu.in.  
 Used with:  
 Manifold: 18-1997-1



**18-8538**  
**EXHAUST MANIFOLD MOUNTING KIT**  
 Barr and Indmar Ford Small Block  
 V8 302-351cu.in.  
 Used with:  
 Manifold: 18-1998-1



**18-8539**  
**EXHAUST MANIFOLD MOUNTING KIT**  
 Volvo 4 Cylinder B20 2.3 and 2.5L (Models:  
 AQ 120, 125, 131, 140, 145, and 151.  
 BB140, 145, 230, and 250) Volvo 4 Cylinder  
 B20 2.3 and 2.5L (Models: AQ 120, 125,  
 131, 140, 145, and 151. BB140, 145, 230,  
 and 250)  
 Used with:  
 Manifold: 18-1930-1



**18-19360**  
**HARDWARE KIT**  
 Used with:  
 Riser: 18-1936



**18-0146**  
**HEAT EXCHANGER GASKET SET**  
 Fits: B21, B23, AQ120B, AQ125A, AQ140A,  
 BB140A, AQ125B, AQ145A, AQ145B, BB145A

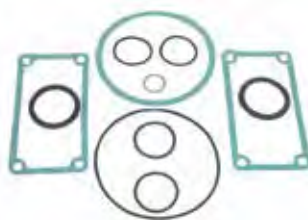

**18-0337**  
**HEAT EXCHANGER GASKET SET**  
 Fits: AD40B, AQAD40A, AQAD40B, TAMD40A,  
 TAMD40B, TMD40B, TMD40C

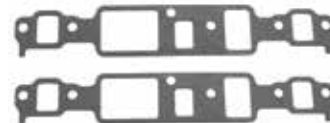

**18-4408**  
**INTAKE MANIFOLD  
 GASKET SET**  
 Replaces: 3850379  
 Fits: 4.3L GL, GS, GI



**18-0476 (Blocked)**  
**RISER BLOCKOFF GASKET**  
 Replaces: Barr 01-0105  
 Indmar & Marine Power Ford  
 Small Block V8 302-351cu.in.  
 Used with:  
 Riser: 18-1939, 18-1999 &  
 18-1907



**PKG. OF 2**  
**18-2854 (Open)**  
**18-2854-9**  
**EXHAUST ELBOW GASKET**  
 Replaces: Barr 01-0107  
 Used with:  
 Manifold: 18-1999, 18-1939,  
 18-1907



**PKG. OF 2**  
**18-2875**  
**18-2875-9**  
**EXHAUST ELBOW GASKET**  
 Replaces: 3850495  
 For: 3.0L GS, GL, GLM, GLP, GSM, GSP

PKG. OF 2



**18-2902**  
**18-2902-9①**  
**MANIFOLD GASKET**  
 Replaces: 3852468  
 For: 5.0L GL, GXI, OSI, 5.7L GL, GI, GXI, GIL, GXIL, OSI, GXIL, OSXI

PKG. OF 2



**18-2949**  
**18-2949-9①**  
**EXHAUST MANIFOLD GASKET**  
 Replaces: Barr CHV-47-000  
 Used with: Manifold: 18-1986-1, 18-1997-1 and 18-1931-1  
 AQ200, 225, 260, 271, 290, 311



**18-2971**  
**EXHAUST MANIFOLD GASKET**  
 Replaces: 835908-5, 856039-3  
 Used with: Riser: 18-1935-1

PKG. OF 4



**18-2991**  
**18-2991-9①**  
**EXHAUST MANIFOLD GASKET**  
 Replaces: 855967, 855383  
 Used with: Manifold: 18-1930-1  
 AQ200, 225, 260, 271, 290, 311



**18-4461**  
**HOSE BARB**  
 3/4" - 14 NPT x 1" Hose  
 Corrosion Resistant Brass Fitting



**PIPE PLUGS**

Part #	Thread Size
18-4256	1/4"
18-4257	1/4"
18-4258	3/4"
18-4263	1/8" - 27 NPT
18-4264	3/8" - 18 NPT

56507 Pipe Sealant with Teflon® is recommended for use on plug threads.



**DRAIN TAPS**

Part #	Replaces:
18-4216	807036
18-4217	82744
18-4218	82745
18-4218D②	
18-4219	829592
18-4697	
18-4699	











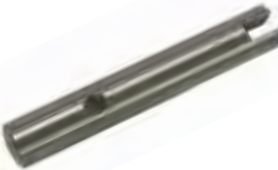



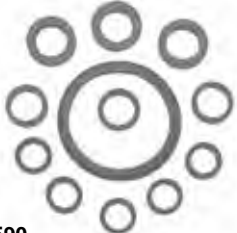

**18-3223-9 ③**  
 Bulk pack of 12 (18-4218)  
 Use with most OEM manifolds

DRAIN TAP APPLICATION			
Model	Thread Size	Location	Tap
MD1A,B,2A,B,3B,5A,B,MD6A	10 x 1	Cyl Block	18-4216
AQ90,95,100,105,110,115,120,130,140A,145A,B,151A,B,170,171A,MB18,20,BB30,100,MD19,21,32	1/8" NPT	Cyl Block	18-4217
AQ90,95,100,110,115,120,125A,B,130,131A,140A,145A,B,151A,B,171A,MB18,MB20,BB30,100,AQD40,AQAD40,TMD40	1/4" NPT	Cyl Block	18-4218
MD5C,11C,D,17C,D	1/8" NPT	Cyl Block	18-4219
B18, B20, B21, B23, B25, B30, D31,	1/4" NPT	Oil Cooler	18-4699
D40, 2001, 2002, 2003 V6, B23, B25, D30, D31, D40, D41	1/4" NPT	Oil Cooler	18-4697

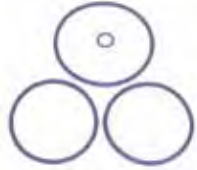
① Priced per Package  
 ② Items ending in "D" are Display Packaged - Regular number is Non-Display  
 ③ This product is priced per piece. To order priced per package, please add -9 to the part number

Model	Exhaust Manifold	Exhaust Elbow	Manifold Mounting Kits	Exhaust Elbow Kits	Manifold Gasket	Elbow Gasket
230	18-1930-1	-	18-8539	-	18-2991	-
250	18-1930-1	-	18-8539	-	18-2991	-
AQ120B	18-1930-1	-	18-8539	-	18-2991	-
AQ125A	18-1930-1	-	18-8539	-	18-2991	-
AQ131A,B,C,D	18-1930-1	-	18-8539	-	18-2991	-
AQ140A	18-1930-1	-	18-8539	-	18-2991	-
AQ145A,B	18-1930-1	-	18-8539	-	18-2991	-
AQ151A,B,C	18-1930-1	-	18-8539	-	18-2991	-
AQ200C,D/280	18-1931-1	18-1935-1	18-8511⑤/18-8502⑥	18-8510	18-2949	18-2971
AQ200D,F	18-1931-1	18-1935-1	18-8511⑤/18-8502⑥	18-8510	18-2949	18-2971
AQ225C,D/280	18-1931-1	18-1935-1	18-8511⑤/18-8502⑥	18-8510	18-2949	18-2971
AQ225D,E,F	18-1931-1	18-1935-1	18-8511⑤/18-8502⑥	18-8510	18-2949	18-2971
AQ255A,B/280	18-1931-1	18-1935-1	18-8511⑤/18-8502⑥	18-8510	18-2949	18-2971
AQ260A,B	18-1931-1	18-1935-1	18-8511⑤/18-8502⑥	18-8510	18-2949	18-2971
AQ290A	18-1931-1	18-1935-1	18-8511⑤/18-8502⑥	18-8510	18-2949	18-2971
AQ430	18-1932	18-1936	-	-	18-2909	18-2971
AQ431	18-1932	18-1936	-	-	18-2909	18-2971
AQ432	18-1932	18-1936	-	-	18-2909	18-2971
AQ434	18-1932	18-1936	-	-	18-2909	18-2971
BB140A	18-1930-1	-	18-8539	-	18-2991	-
BB145A	18-1930-1	-	18-8539	-	18-2991	-
BB225A,B,C	18-1931-1	18-1935-1	18-8511⑤/18-8502⑥	18-8510	18-2949	18-2971
BB260A,B,C	18-1931-1	18-1935-1	18-8511⑤/18-8502⑥	18-8510	18-2949	18-2971
500B	-	18-1936	-	-	18-2909	18-2971
501B	-	18-1936	-	-	18-2909	18-2971
570	18-1931-1	18-1935-1	-	-	18-2909	18-2971
572	-	18-1936	-	-	18-2909	18-2971
740B	-	18-1936	-	-	18-2909	18-2971
LK 4.3L	-	18-1936	-	-	18-2909	18-2971
LK 5.7L	18-1986-1	18-1909-1	18-8502	18-4364⑦/18-8535⑧	18-2949	18-2854⑦/18-0476⑧
HU 5.7 Gi	18-1986-1	18-1909-1	18-8502	18-4364⑦/18-8535⑧	18-2949	18-2854⑦/18-0476⑧
MD 5.7GL / 5.7Gi	18-1986-1	18-1909-1	18-8502	18-4364⑦/18-8535⑧	18-2949	18-2854⑦/18-0476⑧
NC5.7 GL / 5.7Gi	18-1986-1	18-1909-1	18-8502	18-4364⑦/18-8535⑧	18-2949	18-2854⑦/18-0476⑧

⑤ Volvo Configuration Match (Bolts Used in Hardware Kit)      ⑦ Open Gasket  
 ⑥ OMC Configuration Match (Studs Used in Hardware Kit)      ⑧ Closed Gasket

<p>PKG. OF 5</p>  <p><b>18-4236</b> <b>18-4236-9①</b> <b>WASHER</b> Replaces: 941907</p>	 <p><b>18-4150</b> <b>WATER PUMP SHAFT</b> Replaces: 812994 For Pump Without Ball Bearing AQ90, 95, 100, 105, 110, 115, 120, 130, MD3B, 17C</p>	 <p><b>18-2774</b> <b>MOLDED HOSE</b> Replaces: 875847 AQ290, AQ290DP Includes (2) 18-7306 Clamps</p>	 <p><b>18-2775</b> <b>MOLDED HOSE</b> Replaces: 875822 AQDRIVE UNITS 200, 250, 270, 270T, 275, 280, 280T, 280PT, DP UNIT: 280 Includes (2) 18-7306 Clamps</p>
 <p><b>18-2776</b> <b>MOLDED HOSE</b> Replaces: 832831 AQ270T, 280T Includes (2) 18-7306 Clamps</p>	 <p><b>18-0163</b> <b>COOLING PIPE GASKET SET</b> For: B30, AQ165A, AQ170A, AQ170B, AQ170C, BB165A, BB170A, BB170B, BB170C</p>	 <p><b>18-0376</b> <b>COOLING PIPE GASKET SET</b> Fits: D6, D7, MD6A, MD6B, MD7A, MD7B</p>	 <p><b>18-0377</b> <b>COOLING PIPE GASKET SET</b> Fits: B21, B23, AQ120B, AQ125A, AQ140A, BB140A, AQ125B, AQ145A, AQ145B, BB145A</p>
 <p><b>18-0590</b> <b>COOLING PIPE GASKET SET</b> Fits: B20, AQ125A, AQ115B, AQ130A, AQ130B, AQ130C, AQ130D, BB115A, BB115B, BB115C</p>	 <p><b>18-0648</b> <b>COOLING PIPE GASKET SET</b> Fits: D11, D17, MD11C, MD11D, MD17C, MD17D</p>	 <p><b>18-3889</b> <b>COOLING PIPE GASKET SET</b> Fits: B23, B25, 230A, 230B, AQ131A, AQ131B, AQ131C, AQ131D, 250A, 250B, 251A, AQ151A, AQ151B, AQ151C, AQ171A, AQ171C</p>	 <p><b>18-0606</b> <b>COOLING PIPE GASKET SET</b> Fits: B18, B20, AQ60F, AQ90, AQ95, AQ95A, AQ110, AQ120, BB30, BB100, MB18, AQ105A, MB20A, MB20B, MB20C</p>
 <p><b>18-0907</b> <b>OIL DRAIN PLUG GASKET SET</b> For oil plugs: Fits: 200, 250, 270, 270T, 275, 275A</p>	 <p><b>18-3890</b> <b>OIL COOLER GASKET SET</b> Fits: B20, B21, B23, B25, B30, AQ115A, AQ115B, AQ130A, AQ130B, AQ130C, AQ130D, BB115A, BB115B, BB115C, MB20A, MB20B, MB20C, AQ120B, AQ125A, AQ140A, BB140A, 230A, 230B, AQ145A, AQ145B, BB145A, 250A, 250B, 251A, AQ151A, AQ151B, AQ151C, AQ171A, AQ171C, AQ165A, AQ170A, AQ170B, AQ170C, BB165A, BB170A, BB170B, BB170C</p>	 <p><b>18-2777</b> <b>THERMOSTAT HOUSING</b> Replaces: 854031 *AQ120B, *AQ125A, B, AQ130A, B, D, *AQ130C, *AQ131A, AQ140A, AQ145A, *AQ165A, *AQ170A, B, C, *AQ175A, AQ200D, AQ225D, *AQ225E, AQ260A, AQ260B, AQ290A, *AQAD31A, AQD40A, AQD21A, AQAD40A * Models with Power Trim</p>	 <p><b>18-2778</b> <b>THERMOSTAT HOUSING</b> Replaces: 832846 AQ140A, AQ145A, AQ165A, AQ170A, *AQ175D, AQ200D, AQ225D, AQ260A, AQ290A, *AQ280, *AQ280L, AQAD30A, AQAD40A, B *Models with Power Trim</p>
 <p><b>18-3557</b> <b>THERMOSTAT</b> Replaces: 21148403 143°</p>	 <p><b>18-3558</b> <b>THERMOSTAT</b> Replaces: 3853799</p>	 <p><b>18-3654</b> <b>THERMOSTAT KIT (60°C)</b> Replaces: 875779</p>	 <p><b>18-3539</b> <b>THERMOSTAT KIT Closed Cooling System (Includes sealing ring)</b> Replaces: 3831426</p>

① Priced per Package





**18-3538**  
**THERMOSTAT KIT**  
(Includes sealing ring)  
Replaces: 3831424

① **18-3676D** Display Package



**18-3676**  
**THERMOSTAT KIT**  
Replaces: 3853983  
**140°**  
— **Contains** —

Part #	OE#	Description
18-7170	3852071	O-Ring
18-2917	3852111	Gasket
—	3853983	Thermostat

① **18-3670D** Display Package



**18-3670**  
**THERMOSTAT KIT**  
— **CONTAINS** —

Part #	O.E.#	Desc.
18-3558	3853799	Thermostat
18-2858	3852127	Thermostat Housing
—	—	Cover Gasket
18-0929	3852120	Thermostat Gasket

① **18-3677D** Display Package



**18-3677**  
**THERMOSTAT KIT**  
Replaces: 3856961  
**160°**  
— **Contains** —

Part #	OE#	Description
18-7170	3852071	O-Ring
18-2917	3852111	Gasket
—	3856961	Thermostat



**18-3656**  
**THERMOSTAT KIT**  
(60°C)  
Replaces: 876097, 875781

Display Package



**18-3658**  
**THERMOSTAT KIT**  
(74°C)  
Replaces: 875784, 877349



**18-3659**  
**THERMOSTAT KIT**  
(71°C)  
Replaces: 875785



**18-3660**  
**THERMOSTAT KIT**  
(76°C)  
Replaces: 875787, 3831425



**18-3662**  
**THERMOSTAT KIT**  
(62°C)  
Replaces: 875794, 876305



**18-3663**  
**THERMOSTAT KIT**  
(55°C)  
Replaces: 875791



**18-3664**  
**THERMOSTAT KIT**  
(74°C)  
Replaces: 875795



**18-3665**  
**THERMOSTAT KIT**  
(60°C)  
Replaces: 875796



**18-3666**  
**THERMOSTAT KIT**  
(82°C)  
Replaces: 875580



**18-3615**  
**THERMOSTAT - RAW WATER**  
Replaces: 3587597



**18-3617**  
**THERMOSTAT KIT**



**18-3620**  
**THERMOSTAT KIT**



**18-3621**  
**THERMOSTAT KIT**



**18-3626**  
**THERMOSTAT KIT**



**18-3618**  
**THERMOSTAT KIT - RAW WATER COOLED**



**18-3619**  
**THERMOSTAT KIT - FRESH WATER COOLED**

**THERMOSTAT APPLICATION ON NEXT PAGE**

① Items ending in "D" are Display Packaged - Regular number is Non-Display

**RAW WATER (OPEN) COOLING SYSTEM - RAW (RIVER, LAKE, SEA) WATER RUNS THROUGH CYLINDER BLOCK**

Model	Version	Identifier	Model Year	Thermostat	Seal	Gasket	Thermostat & Seal Kit	Complete Kit Thermostat Seal Gasket
AQ90			1962-1964	NSS	18-2933		18-3656	
AQ95			1964-1968	NSS	18-2933		18-3656	
AQ100			1961-1963	NSS	18-2933		18-3656	
AQ130	A, B, C, D		1968-1977	NSS	18-2933		18-3656	
AQ115	A, B		1969-1975	NSS	18-2933		18-3656	
AQ140	A		1975-1979	NSS	18-2933	18-7181	18-3666	18-3620
AQ120	B		1977-1980	NSS	18-2933	18-7181	18-3666	18-3620
AQ145	A, B		1979-1985	NSS	18-2933	18-7181	18-3666	18-3620
AQ125	A, B		1981-1985	NSS	18-2933	18-7181	18-3666	18-3620
AQ131	A, B, C, D		1985-1989	NSS	18-2933	18-7181	18-3666	18-3620
230	A, B		1989-1993	NSS	18-2933	18-7181	18-3666	18-3620
AQ151	A, B, C		1985-1989	NSS	18-2933	18-7181	18-3666	18-3620
AQ171	A, C		1986-1989	NSS	18-2933	18-7181	18-3666	18-3620
250	A, B		1986-1993	NSS	18-2933	18-7181	18-3666	18-3620
251	A		1989-1992	NSS	18-2933	18-7181	18-3666	18-3620
3.0 GL, GS		MD,HU,NC	1993-1996	18-3558	18-0929	18-2858		18-3670
3.0 GL, GL, GSP, GLP, GLM		LK,BY,WT,EF	1996-2000	18-3558	NSS	18-0164		18-3621
3.0 GLP, GLM, GSP, GSM	A, B, C, D, E, J		2000-Current	18-3558	NSS	18-0164		18-3621
3.0 GXi, 3.0GXiC	J		2009-Current	18-3557	NSS	18-0164		18-3626
AQ175			1981-1985	18-3551	18-2933	18-0398		18-3662
AQ205	A		1988-1989	18-3551	18-2933	18-0398		18-3662
431	A, B		1989-1991	18-3551	18-2933	18-0398		18-3662
430	A, B		1990-1991	18-3551	18-2933	18-0398		18-3662
432	A		1992-1993	18-3551	18-2933	18-0398		18-3662
434	A		1992-1993	18-3551	18-2933	18-0398		18-3662
4.3 (All Models)		MD,HU,NC,LK, BY,WT,EF	1993-2000	NSS	18-7170	18-2917		18-3677
4.3 (All Models)	A, B		2001-2002	NSS	18-7170	18-2917		18-3677
4.3 (All Models)	C, D, E, F, G, J		2002-Current	NSS	NSS	18-2917	18-3615	18-3618
AQ190	A		1976-1977	18-3551		18-0398		18-3662
AQ200	B,C		1974-1976	18-3551		18-0398		18-3662
AQ225	B, C		1974-1976	18-3551		18-0398		18-3662
AQ200	D, F		1977-1986	18-3551		18-0398		18-3662
AQ225			1977-1986	18-3551	18-2933	18-0398		18-3662
AQ211	A		1986-1989	18-3551	18-2933	18-0398		18-3662
AQ231			1986-1989	18-3551	18-2933	18-0398		18-3662
500			1989-1993	18-3551	18-2933	18-0398		18-3662
501			1989-1993	18-3551	18-2933	18-0398		18-3662
5.0 FiP, FLP		MD,HU,NC	1993-1996	NSS	18-7170	18-2917		18-3677
5.0 GiP, GLP		BY,WT,EF	1997-2000	NSS	18-7170	18-2917		18-3677
5.0 GL, GXi, OSi	A, B		2001-2003	NSS	18-7170	18-2917		18-3677
5.0 (All Models)	C, D, E, F, G, H, J, K		2002-Current	NSS	NSS	18-2917	18-3615	18-3618
AQ271	A, B		1986	18-3551	18-2933	18-0398		18-3662
AQ260	A, B		1979-1985	18-3551	18-2933	18-0398		18-3662
AQ311	A		1986-1987	18-3551	18-2933	18-0398		18-3662
AQ271	C		1986-1989	18-3551	18-2933	18-0398		18-3662
AQ255	A, B		1977-1978			18-0398		
571	A		1989-1992	18-3551	18-2933	18-0398		18-3662
5.7 (All Models)		MD, HU, NC, LK, BY, WT, EF	1993-2000	NSS	18-7170	18-2917		18-3677
5.7 (All Models Except OSi)	A, B, C		2001-2003	NSS	18-7170	18-2917		18-3677
5.7 OSi, OSXi	B, C		2001-2003	NSS	NSS	18-2917	18-3615	18-3618
5.7 (All Models)	D, E, F, G, H, J, K		2002-Current	NSS	NSS	18-2917	18-3615	18-3618
5.8 (All Models)		HU, NC	1993-1996	NSS	18-7170	18-2917		18-3677
740	A, B		1991-1993	18-3551	18-2933	18-0398		18-3662
7.4 (All Models)		MD, HU, NC, LK, BY, WT, EF	1993-2000	NSS	18-7170	18-2917		18-3676
8.1 (All Models)			2000-Current	NSS	18-7170	NSS		18-3617
8.2 (All Models)		MD, HU, NC, LK, BY, WT, EF	1993-2000	NSS	18-7170	18-2917		18-3676
<b>FRESH WATER (CLOSED) COOLING SYSTEM - ENGINE IS EQUIPPED WITH RESEVOIR TO HOLD ANTI-FREEZE</b>								
4.3, 5.0, 5.7 (All Models)			1993 - Current	NSS	18-2933	18-2917	18-3539	18-3619
5.8 (All Models)			1993 - 1996	NSS	18-2933	18-2917	18-3539	18-3619
7.4 (All Models)			1991 - 2000	NSS	18-2933	18-2917	18-3539	18-3619
8.1 (All Models)			2000-Current	NSS	18-2933	18-2917	18-3539	18-3619
8.2 (All Models)			1993 - 2000	NSS	18-2933	18-2917	18-3539	18-3619

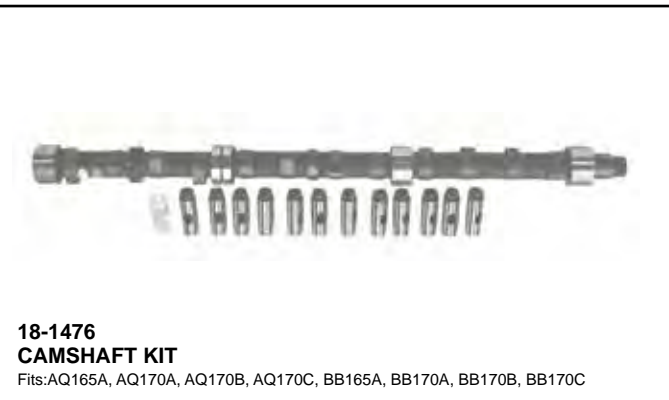

**18-1476**  
**CAMSHAFT KIT**  
 Fits:AQ165A, AQ170A, AQ170B, AQ170C, BB165A, BB170A, BB170B, BB170C



**18-1477**  
**CAMSHAFT KIT**  
 Fits:B18, B20, AQ60F, AQ90, AQ95, AQ110, AQ120, BB30, BB100, MB18, AQ105, AQ115A, AQ115B, AQ130A, AQ130B, AQ130C, AQ130D, BB115A, BB115B, BB115C, MB20A, MB20B, MB20C

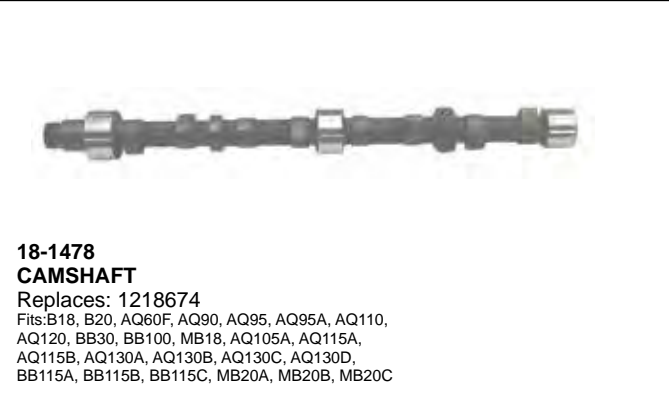

**18-1478**  
**CAMSHAFT**  
 Replaces: 1218674  
 Fits:B18, B20, AQ60F, AQ90, AQ95, AQ95A, AQ110, AQ120, BB30, BB100, MB18, AQ105A, AQ115A, AQ115B, AQ130A, AQ130B, AQ130C, AQ130D, BB115A, BB115B, BB115C, MB20A, MB20B, MB20C



**18-1479**  
**CAMSHAFT**  
 Replaces: 461511  
 Fits:B30, AQ165A, AQ170A, AQ170B, AQ170C, BB165A, BB170A, BB170B, BB170C



**VALVES**

Part #	Type	O.E. #	Application
18-4464	Exhaust	829620	D1, D2, D3, 3AA, D17, AQD2B, MD1B, MD2B, MD3B, MD11C, MD11D, MD17C, MD17D
18-4469	Exhaust	1542389	D40, AD40B, AQAD40A, AQAD40B, AQD40A, MD40A, TAMD40A, TAMD40B, TMD40A, TMD40B, TMD40C
18-4470	Exhaust	419735	B20, B30, AQ105A, AQ115A, AQ115B, AQ130A, AQ130B, AQ130C, AQ130D, BB115A, BB115B, BB115C, MB20A, MB20B, MB20C
18-4471	Exhaust	838638	D31, D32, D41, D42, D43, AD31L-A, AD31P-A, TAMD31L-A, TAMD31M-A, TAMD31P-A, TMD31L-A, KAD32PA, AD41L-A, AD41P-A, D41L-A, TAMD41H-A, TAMDS41L-A, TAMD41P-A, TMD41A, TMD41L-A, KAD42A, KAD42P-A, KAMD42A, KAMD42B, KAMD42P-A, TAMD42B, TAMD42WJ-A, KAD43P-A, KAMD43P-A
18-4463	Intake	833188	D1, D2, D3, 3AA, D17, AQD2B, MD1B, MD2B, MD3B, MD11C, MD11D, MD17C, MD17D
18-4466	Intake	838637	D31, D32, D41, D42, D43, AD31L-A, AD31P-A, TAMD31L-A, TAMD31M-A, TAMD31P-A, TMD31L-A, KAD32PA, AD41L-A, AD41P-A, D41L-A, TAMD41H-A, TAMDS41L-A, TAMD41P-A, TMD41A, TMD41L-A, KAD42A, KAD42P-A, KAMD42A, KAMD42B, KAMD42P-A, TAMD42B, TAMD42WJ-A, KAD43P-A, KAMD43P-A
18-4467	Intake	1542472	D40, AD40B, AQAD40A, AQAD40B, AQD40A, MD40A, TAMD40A, TAMD40B, TMD40A, TMD40B, TMD40C
18-4468	Intake	419734	B20, B30, AQ105A, AQ115A, AQ115B, AQ130A, AQ130B, AQ130C, AQ130D, BB115A, BB115B, BB115C, MB20A, MB20B, MB20C



**18-4465**  
**VALVE GUIDE**  
 Replaces: 3582609  
 for exhaust: 230, 250, AQ115, BB115, MB20, AQ130, AQ165, BB165, AQ170, BB170, AQD21A, MD21A, AQ120B, AQ125A, AQ140A, BB140A, AQ125B, AQ131A, AQ131B, AQ131C, AQ131D, AQ145A, BB145A, AQ145B, AQ151A, AQ151B, AQ151C, MB10



**18-4472**  
**VALVE LIFTER**  
 Replaces: 1218630  
 Fits:B18, B20, B30, AQ120, AQ90, AQ95, AQ110, AQ120, BB30, BB100, MB18, AQ105A, AQ115A, AQ115B, AQ130A, AQ130B, AQ130C, AQ130D, BB115A, BB115B, BB115C, MB20A, MB20B, MB20C, AQ165A, AQ170A, AQ170C, BB165A, BB170A, BB170B, BB170C



**18-4473**  
**VALVE GUIDE**  
 Replaces: 419653, 35882561  
 Fits:AQ115, BB115, MB20, AQ130, AQ165, AQ170, BB170, AQD21A, MD21A, KAMD42A, KAD42A, KAMD42P, KAD42P, MD11, MD17, MD1B, MD2B, MD3B, MD30, TMD30, TAMD30, AQAD30, MD31A, TMD31B, TAMD40, AQAD40, TAMD42B, KAMD42B, KAD42B, TMD31D, TAMD31D, AD31D, AD31XD, TMD41B, TAMD41B, D41B, TMD41D, TAMD41D, D41D, AD41D



**18-4474**  
**VALVE GUIDE**  
 Replaces: 419652, 3582606  
 For intake: Fits:230, 250, AQ115, BB115, MB20, AQ130, AQ165, BB165, AQ170, BB170, AQD21A, MD21A, AQ120B, AQ125A, AQ140A, BB140A, AQ125B, AQ131A, AQ131B, AQ131C, AQ131D, AQ145A, BB145A, AQ145B, AQ151A, AQ151B, AQ151C, MB10



**18-4029**  
**TIMING BELT**  
 Replaces: 463377  
 AQ120B, 125A,B, 131A,B,C,D 140, 145, 151A,B,C, 230, 250, BB140A, 145A,B 4 Cyl.



**18-4044**  
**DRIVE BELT**  
 Replaces: 834548, 966694-2  
 Generator: AQ120B, 125A, 140A, 145A, 165, 170A, B, C



**18-4046**  
**DRIVE BELT**  
 Replaces: 958498, 966857  
 Generator:AQ175A, 200A, B, C, D, 225A,B, 260A, B, 280A, 290A  
 Water Pump AQ210  
 V-6, V-8



**EXPANSION PLUGS**

Part #	Pkg.	O.E. #	Size
18-4200 ① ②	5	477024	35MM (1.375")
18-4201 ① ②	5	192212	45MM (1.770")
18-4245 ②	5	463902	42MM (1.655")
18-4246 ②	5	463903-5	35MM (1.375")
18-4247 ②	5	463904	45MM (1.770")

① Stainless Steel  
 ② This product is priced per piece. To order priced per package, please add -9 to the part number.



**18-2367  
CYLINDER HEAD NUT**

Replaces: 943414  
 For cylinder head: Fits: D1, D2, D3, D11, D17, MD1B, AQD2B, MD2B, MD11C, MD11D, MD3B, MD17C, MD17D



**18-2793  
SEAL RING KIT**

Replaces: 875550  
 For cylinder liner: Fits:D11, D17, MD11C, MD11D, MD17C, MD17D: NOTE: Model MD11 requires two 18-2793 and Model MD17requires three 18-2793



**18-1727  
RUBBER CUSHION**

Replaces: 803762  
 For propeller shaft coupler:  
 Fits: B18, B20, B30, MB10, 2001, 2002, 2003, 2010, 2020, 2030, 2040, D1, D2, D3, D5, D6, D7, D11, D17, D21, D22, D29, D32, BB30, BB100, BB115, BB165, BB170, MB10A, MB18, MB20, MD1, MD2, MD3, MD5, MD6, MD7, MD11, MD17, MD21, MD22, MD29, MD32



**18-4005  
ENGINE MOUNT**

Replaces: 833950  
 Fits:D5, D6, D7, D11, D17, MB10, MB10A, MD5A, MD5B, MD5C, MD6A, MD6B, MD7A, MD7B, MD11C, MD11D, MD17C, MD17D



**18-7907  
AIR FILTER**

Replaces: 858488  
 Fits:D31, D41, D42, AD31A, AD31B, AD31D, AD31L-A, AD31P-A, AD31XD, AQAD31A, MD31A, TAM31A, TAM31B, TAM31D, TAM31L-A, TAM31M-A, TAM31P-A, TAM31A, TAM31B, TAM31D, TAM31L-A, AD41A, AD41B, AD41D, AD41L-A, AD41P-A, AQAD41A, D41A, D41B, D41D, D41L-A, TAM41A, TAM41B, TAM41D, TAM41H-A, TAM41L-A, TAM41M-A, TAM41P-A, TMD41A, TMD41B, TMD41D, TMD41L-A, TMD42B, TAM42WJ-A



**18-7908  
AIR FILTER**

Replaces: 3582358  
 Fits:D31, D41, AD31A, AD31B, AD31D, AD31L-A, AD31P-A, AD31XD, AQAD31A, TAM31A, TAM31B, TAM31D, TAM31L-A, TAM31M-A, TAM31P-A, TAM31A, TAM31B, TAM31D, TAM31L-A, AD41D, AD41L-A, AD41P-A, AQAD41A, AQD41A, D41A, D41B, D41D, D41L-A, TAM41A, TAM41B, TAM41D, TAM41H-A, TAM41L-A, TAM41M-A, TAM41P-A, TMD41A, TMD41B, TMD41D, TMD41L-A



**18-7890  
AIR FILTER**

Replaces:  
 463505, 876185  
 MD30, MD40, KAD42A, KAMD42A  
 Diesel



**18-0035  
DIESEL OIL FILTER, FULL FLOW**

Replaces: 3582732  
 Fits: D4-180i-B, D4-180i-C, D4-210A-A, D4-210A-B, D4-210i-A, D4-210i-B, D4-225A-B, D4-225A-C, D4-225i-B, D4-225i-C, D4-260A-A, D4-260A-B, D4-260A-C, D4-260D-B, D4-260D-C, D4-260i-A, D4-260i-B, D4-260i-C, D4-300A-A, D4-300A-C, D4-300D-A, D4-300D-C, D4-300i-A, D4-300i-C, D6-280A-A, D6-280A-B, D6-280i-A, D6-280i-B, D6-310A-A, D6-310A-B, D6-310D-A, D6-310D-B, D6-310i-A, D6-310i-B, D6-330A-B, D6-330A-C, D6-330D-B, D6-330D-C, D6-330i-B, D6-330i-C, D6-350A-A, D6-350A-B, D6-370A-B, D6-370A-C, D6-370D-A, D6-370D-B, D6-370D-C, D6-370i-A, D6-370i-B, D6-370i-C, D6-435D-A, D6-435D-C, D6-435i-A, D6-435i-C



**18-0036  
DIESEL OIL FILTER, BYPASS**

Replaces: 3582733  
 Fits: D4-180i-B, D4-180i-C, D4-210A-A, D4-210A-B, D4-210i-A, D4-210i-B, D4-225A-B, D4-225A-C, D4-225i-B, D4-225i-C, D4-260A-A, D4-260A-B, D4-260A-C, D4-260D-B, D4-260D-C, D4-260i-A, D4-260i-B, D4-260i-C, D4-300A-A, D4-300A-C, D4-300D-A, D4-300D-C, D4-300i-A, D4-300i-C, D6-280A-A, D6-280A-B, D6-280i-A, D6-280i-B, D6-310A-A, D6-310A-B, D6-310D-A, D6-310D-B, D6-310i-A, D6-310i-B, D6-330A-C, D6-330D-B, D6-330D-C, D6-330i-B, D6-330i-C, D6-350A-A, D6-350A-B, D6-370A-B, D6-370A-C, D6-370D-A, D6-370D-B, D6-370D-C, D6-370i-A, D6-370i-B, D6-370i-C, D6-435D-A, D6-435D-C, D6-435i-A, D6-435i-C



**18-7974  
OIL FILTER**

Replaces: 3827069  
 Thread Specs: 18mm x 1.5  
 Fits: Diesel Models AQD21A-B, AQD32A, MD21A/B, MD32A, TAM61A, TAM62A, TAM63L-A, TAM63P-A, TAM671A/B, TAM672A, TAM673P-A, TAM673WJ-A, TAM674A-A, TAM674A-B, TAM674C-A, TAM674C-B, TAM674P-B, TAM675P-A

SEE PAGES 152-154 FOR ADDITIONAL INFORMATION

**OIL FILTERS**

Part #	O.E. #	Application
18-8003	8692305	—
18-7824-1	835440	Short GM Filter
18-7876	3850559	Long GM Filter
18-7878-1	430143, 1266286, 3517857	Short Ford Filter
18-7879	841750	V-6 GM

**DIESEL OIL FILTER**

18-0032	847741	—
18-0033	478436	—
18-0034	477556	—
18-7880	466634	TAMD100, TMD102, TMD121, TMD122, TAMD122 & TAMD162
18-7884	834337	—
18-7974	3827069	—

# CYLINDER HEAD ASSEMBLIES

*All cylinder heads are new castings and complete assemblies with new - stainless steel valves, hardened steel exhaust seats, valve springs, valve locks, and retainers.  
All GM cylinder heads utilize high performance screw-in rocker arm studs in place of factory press in rocker arm studs.*



**18-4484  
CYLINDER HEAD ASSEMBLY**

Fits: 5.7L V-8 GM (1969-86) with 12 intake manifold mounting bolts, perimeter mount valve cover



**18-4485  
CYLINDER HEAD ASSEMBLY**

Fits: 5.7L V-8 GM (1987-95) with press in rocker arm studs with 12 intake manifold mounting bolts- (4 inside intake manifold bolts at 23 degrees), center mount valve covers



**18-4486  
CYLINDER HEAD ASSEMBLY**

Fits: 5.7L V-8 GM Vortec (1996-Up) with press in rocker arm studs with 8 intake manifold mounting bolts, composite valve cover



**18-4489  
CYLINDER HEAD ASSEMBLY**

Fits: 2.5L/3.0L GM (1968-95) (non MerCruiser LX models) (1968-95)



**18-4491  
CYLINDER HEAD ASSEMBLY**

Replaces 4.3L Vortec V-6 (1996-Up) with screw in rocker arm studs (non-adjustable valve train), 8 intake manifold mounting bolts, center mount valve cover. NOTE: not for use with engines using factory roller rocker arms.



**18-4495  
CYLINDER HEAD ASSEMBLY**

Replaces: 3854339,3853894  
Fits: (1980& Up) 5.0L Ford with D-shape 58 cc combustion chamber



**18-4501  
CYLINDER HEAD**

Fits: 5.0L Vortec



**18-4502  
CYLINDER HEAD  
High Performance**

Aluminum cylinder head sold in pairs only. This utilizes a 185cc intake runner/62cc exhaust runner and 2.02/1.60 stainless valves placed in a 72cc combustion chamber.  
Fits: 5.7, 6.2L GM small block V-8



**18-1400**  
**HYDRAULIC LIFTER**  
 Replaces: 3856127  
 GM 4.3L/V-6 Late/5.0L/5.7L



**18-1401**  
**HYDRAULIC LIFTER**  
 Replaces: 3853847, 985316  
 Ford 302/351  
 Ford 5.0L & 5.8L



**18-1402**  
**HYDRAULIC LIFTER**  
 Replaces: 3854033, 502036  
 GM 2.5L/120  
 For: Volvo 3.0L/181 CID GM 3.0L, 4.3L, 5.0L & 5.7L

**ALL PISTONS  
 ARE SUPPLIED COMPLETE WITH PISTON RINGS AND WRIST PIN.**



**RINGS**

STD	OMC / VOLVO
18-3937	*14089025
18-3937	328506
18-3937	3853960
18-3937	914555
18-3937	3853268
18-3937	985083, 986336
18-3940	328536
18-3944	370409

**RINGS (Cont.)**

STD	OMC / VOLVO
.020	
18-3939	3854252
18-3939	914556
.030	
18-3938	*14089026
18-3938	328516
18-3938	914557

**PISTONS**

18-4161	3853340
	914816
18-4173	*14077948
18-4173	3911020
.020	
18-4160	3853477, 915236
.030	
18-4164	*14077949
	3911023
* OMC References GM Number	

**PISTON/ RING APPLICATION**

VOLVO		PISTONS			RINGS			Qty.
Model	Serial Number	Std.	.020	.030	Std.	.020	Per .030	Eng.
<b>GM</b>								
2.5L/153 CID		18-4180	18-4183	-	18-3942	-	-	4
3.0L/181 CID		18-4161	18-4160	18-4191	18-3937	18-3939	18-3938	4
4.3L/V-6		18-4173	18-4188	18-4164	18-3937	18-3939	18-3938	6
5.0L/305 CID		-	-	18-4178	18-3944	-	-	8
5.7L/350 CID		18-4173	18-4188	18-4164	18-3937	18-3939	18-3938	8
7.4L/454 CID		18-4171	18-4189	18-4172	18-3940	18-3950	18-3941	8
<b>FORD</b>								
5.0L/302 CID		-	-	-	18-3937	18-3939	18-3938	8

 <p><b>ROD BEARINGS</b></p> <table border="1"> <thead> <tr> <th>Part #</th> <th>Size</th> </tr> </thead> <tbody> <tr><td>18-1308</td><td>Std.</td></tr> <tr><td>18-1309</td><td>.010</td></tr> <tr><td>18-1327</td><td>Std.</td></tr> <tr><td>18-1332</td><td>.020</td></tr> <tr><td>18-1333</td><td>.010</td></tr> <tr><td>18-1334</td><td>Std.</td></tr> <tr><td>18-1337</td><td>.010</td></tr> <tr><td>18-1341</td><td>.020</td></tr> </tbody> </table> <p><b>Rod bearings sold individually, 1 per rod</b></p>		Part #	Size	18-1308	Std.	18-1309	.010	18-1327	Std.	18-1332	.020	18-1333	.010	18-1334	Std.	18-1337	.010	18-1341	.020	 <p><b>MAIN BEARINGS</b></p> <table border="1"> <thead> <tr> <th>Part #</th> <th>Per Eng.</th> <th>Size</th> <th>Part #</th> <th>Per Eng.</th> <th>Size</th> </tr> </thead> <tbody> <tr> <td>18-1300</td> <td>②</td> <td>Std.</td> <td>18-1316</td> <td>②</td> <td>.010</td> </tr> <tr> <td>18-1311</td> <td>②</td> <td>Std.</td> <td>18-1317</td> <td>②</td> <td>Std.</td> </tr> <tr> <td>18-1315</td> <td>②</td> <td>Std.</td> <td></td> <td></td> <td></td> </tr> </tbody> </table>			Part #	Per Eng.	Size	Part #	Per Eng.	Size	18-1300	②	Std.	18-1316	②	.010	18-1311	②	Std.	18-1317	②	Std.	18-1315	②	Std.				 <p><b>CAM BEARINGS</b></p> <table border="1"> <thead> <tr> <th>Part #</th> <th>Per Eng.</th> </tr> </thead> <tbody> <tr> <td>18-1339</td> <td>1 ②</td> </tr> </tbody> </table>		Part #	Per Eng.	18-1339	1 ②
Part #	Size																																																			
18-1308	Std.																																																			
18-1309	.010																																																			
18-1327	Std.																																																			
18-1332	.020																																																			
18-1333	.010																																																			
18-1334	Std.																																																			
18-1337	.010																																																			
18-1341	.020																																																			
Part #	Per Eng.	Size	Part #	Per Eng.	Size																																															
18-1300	②	Std.	18-1316	②	.010																																															
18-1311	②	Std.	18-1317	②	Std.																																															
18-1315	②	Std.																																																		
Part #	Per Eng.																																																			
18-1339	1 ②																																																			

**BEARING APPLICATION**

Model	ROD BEARING			MAIN BEARING			CAM BEARING
	Std.	.010	.020	Std.	.010	.020	
<b>VOLVO</b>							
<b>GM</b>							
3.0L/181 CID	18-1308	18-1309	18-1341	18-1317	18-1316	-	18-1339
4.3L/V-6	18-1327	18-1337	-	18-1311	-	-	-
5.0L/305 CID	18-1308	18-1309	18-1341	18-1300	-	-	-
5.7L/350 CID	18-1308	18-1309	18-1341	18-1300	-	-	-
7.4L/454 CID	18-1334	18-1333	18-1332	18-1315	-	-	-
<b>FORD</b>							
5.0L/302 CID	—	-	-	-	-	-	-

 <p><b>18-0518 VALVE STEM SEAL</b> Replaces: 3854956, 914323, 3853132 For: most inline 4 and 6 cyl. GM (Early) and 305-350 CID GM</p>	<p>PKG. OF 8</p>  <p><b>18-4024 18-4024-9① VALVE STEM SEAL</b> Replaces: 3853226, 914445 For: Chevy 4.3L/5.0L/5.7L</p>	 <p><b>18-4031 VALVE STEM SEAL</b> Replaces: 1306630 AQ120B, 125A, B, 131A, 140A, 145A, B, 151A, B, MD1B, 2B, 3B, 5A, 2001, 2002, 2003, MD5B, C, 11C, D, 17C, D, 30, 31, 40, 41</p>
--	---	--

 <p><b>One Piece Rear Main Seals</b></p> <p><b>18-1234</b> Replaces: 3853528 For: 7.4L, GL, GI, GSI: 8.2L, GL</p> <p><b>18-0519</b> Replaces: 3852657, 912957 4.3L/3.0L/5.0L 5.7L</p>	 <p><b>Two Piece Rear Main Seals</b></p> <p><b>18-0528</b> Replaces: 3852805</p> <p><b>18-1211</b></p>	 <p><b>Timing Cover Seals</b></p> <p><b>18-1213</b> Replaces: 3853341</p> <p><b>18-1230</b> Replaces: 3853827</p>
--	--	--

① Priced per Package

② Complete Engine Set

VOLVO SEAL APPLICATION		
Engine Model	2 Piece Rear Main Crankshaft Seal Conv. Rotation (LH)	Timing Cover Seal
<b>GM</b>		
3.0L/181 CID	18-1211 ②	18-1213
4.3L/V-6	18-1211 ②	18-1213
5.0L/305 CID	18-1211 ①	18-1213
5.7L/350 CID	18-1211 ①	18-1213
7.4L/454 CID	③	18-1233
<b>FORD</b>		
5.0L/302 CID	18-0528	18-1230
5.8L/351 CID	—	18-1230

① Large Journal Crankshaft GM Engine    ② For one piece seal (LH) models use 18-0519    ③ For one piece seal (LH) models use 18-1234

**FOR MODULAR GASKET SETS SEE PAGES 570-577**



**18-0252  
CONVERSION GASKET SET**  
Replaces: 876314  
Fits: D6, D7, MD6A, MD6B, MD7A, MD7B



**18-0489  
CONVERSION GASKET SET**  
Replaces: 876384  
Fits: D11, MD11C, MD11D



**18-2814  
SHORT BLOCK GASKET SET**  
Replaces: 876306  
(6 CYL.)



**18-2699  
OUTDRIVE  
GASKET**  
For: SX and DP-SM Drives thru 2006  
— CONTAINS —

Part #	Description	O.E. #	Qty.
18-7153	O-Ring	911851	2
18-2996	Outdrive Seal	911823	1



**18-2596  
HEAD GASKET SET**  
Replaces: 875422  
Fits: D1, D2, D1A, MD1A, D2A, MD2, MD2A:  
NOTE: Model MD2A requires two 18-2596



**18-3870  
HEAD GASKET SET**  
Replaces: 876303  
Fits: B25, 251A, AQ171A, AQ171C



**18-4341  
HEAD GASKET SET**  
Replaces: 876380  
Fits: D17, MD17C, MD17D



**18-4342  
HEAD SET**  
Replaces: 876376  
Fits: D11, MD11C, MD11D



**18-2813  
HEAD GASKET SET**  
Replaces: 876302  
(4 CYL.)



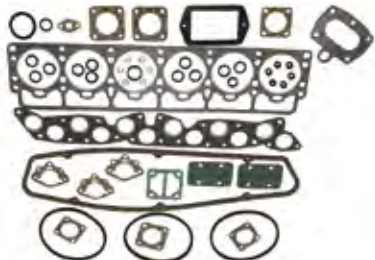

**18-2816  
HEAD GASKET SET**  
Replaces: 876337  
(6 CYL.)

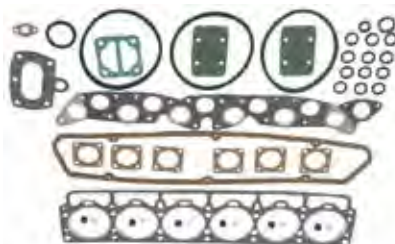

**18-2817  
HEAD GASKET SET**  
Replaces: 876359  
(6 CYL.)



**18-2818  
OIL PAN GASKET SET**  
Replaces: 876433  
(4 CYL.)



**18-2980  
HEAD GASKET SET**  
Replaces: 875401 (Old), 876356  
(4 CYL.)



**18-2982  
HEAD GASKET SET**  
Replaces: 875569 (Old), 876358  
(4 CYL.)



**18-2983  
SHORT BLOCK GASKET SET**  
Replaces: 875400 (Old), 876342  
(4 CYL.)



**18-2998  
HEAD GASKET SET**  
Replaces: 3876300  
(4 CYL.)



**18-0410  
INTAKE MANIFOLD  
GASKET SET**  
Replaces: 3853912, 3853913, 3854406  
For: Volvo 5.0L FL, FI, 5.8L FL, FI, FSI



**18-0868  
INTAKE MANIFOLD  
GASKET SET**  
Replaces: 3854269



**18-1238  
INTAKE GASKET SET**  
Replaces: 3850379, 912979  
For: Volvo 4.3GL/GS 1994-96, 4.3Gi 1995-97



**18-0498  
HEAD GASKET**  
Replaces: 3580309  
Fits: MD2030A, MD2030B



**18-2811  
HEAD GASKET**  
Replaces: 461618  
(6 CYL.)

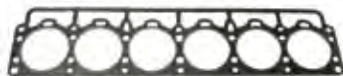













**18-2812  
HEAD GASKET**  
Replaces: 430107  
(6 CYL.)



**18-2946  
HEAD GASKET**  
Replaces: 3853336, 908611  
Fits: GM 181 (3.0L) CID Eng.



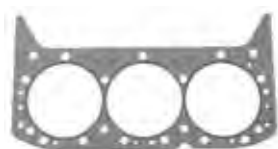

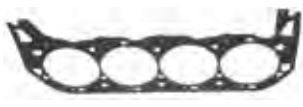

















**18-2965  
HEAD GASKET**  
Replaces: 419310, 419763-8  
(4 CYL.)

 <p><b>18-2966 HEAD GASKET</b> Replaces: 462623 (4 CYL.)</p>	 <p><b>18-2968 HEAD GASKET</b> Replaces: 1378645 (4 CYL.)</p>	 <p><b>18-2970 HEAD GASKET</b> Replaces: 1378646 (4 CYL.)</p>	
 <p><b>18-3834 HEAD GASKET</b> Replaces: 833453</p>	 <p><b>18-3842 HEAD GASKET</b> Replaces: 833274 Fits:D1,D2, MD1A, MD2A</p>	 <p><b>18-3843 HEAD GASKET</b> Replaces: 859155 Fits:D40, AD40B, AQAD40A, AQAD40B, AQD40A, MD40A, TAMD40A, TAMD40B, TMD40B, TMD40C</p>	 <p><b>18-3867 HEAD GASKET</b> Replaces: 859647 Fits:MD22A, MD22L-A, MD22L-B, MD22P-B, TAMD22P-B, TMD22A, TMD22B</p>
 <p><b>18-3868 HEAD GASKET</b> Replaces: 3583786 Fits:D41, D42, D43, D44, AD41A, AD41B, AD41D, AD41L-A, AD41P-A, AQAD41A, D41A, D41B, D41D, D41L-A, TAMD41A, TAMD41B, TAMD41D, TAMD41H-A, TAMD41L-A, TAMD41M-A, TAMD41P-A, TMD41A, TMD41B, TMD41D, TMD41LA, KAD42A, KAD42B, KAD42P-A, KAMD42A, KAMD42B, KAMD42P-A, TAMD42B, TAMD42WJ-A, KAD43P-A, KAMD43P-A, KAD44P-A, KAD44P-B, KAD44P-C, KAMD44P-A, KAMD44P-B, KAMD44P-C</p>		 <p><b>18-3873 HEAD GASKET</b> Replaces: 3853587 Fits:7.4L GL, GI, GSI, 8.2L GL</p>	 <p><b>18-3869 HEAD GASKET</b> Replaces: 3584202 Fits:MD2040A, MD2040B</p>
 <p><b>18-3876 HEAD GASKET</b> Replaces: 841207-4, 856474-2 Fits: GM 305 (5.0L)/350 (5.7L) CID Eng.</p>	 <p><b>18-3879 HEAD GASKET</b> Replaces: 3854299, 912227, 914930 Fits: GM 262 (4.3L) CID Eng.</p>	 <p><b>18-3883 HEAD GASKET</b> Replaces: 3853732 Fits: Ford 302 (5.0L) 351 (5.8L) CID Eng.</p>	 <p><b>18-3887 HEAD GASKET</b> Replaces: 3853511 For: Volvo 7.4L</p>





















**HEAD GASKET SET/GASKET SET/HEAD GASKET APPLICATION**

Model	Head Gasket Set	Gasket Set	Head Gasket	Model	Head Gasket Set	Gasket Set	Head Gasket	Model	Head Gasket Set	Gasket Set	Head Gasket
AQ60	—	18-2983	—	AQ140A	18-2998	18-2818	18-2968	BB115C	—	—	18-2966
AQ90	—	18-2983	—	AQ145A	—	18-2818	18-2970	BB140A	18-2998	18-2818	18-2968
AQ95	—	18-2983	—	AQ145B	18-2813	—	18-2970	BB145A	18-2999	18-2818	—
AQ100	—	18-2983	—	AQ151A,B,C	18-2813	—	18-2970	BB165	—	18-2814	—
AQ105	—	18-2983	—	AQ165	—	18-2814	18-2812	BB170C	18-2817	18-2814	18-2811
AQ110	—	18-2983	—	AQ170A	—	18-2814	18-2812	BB30	—	18-2983	—
AQ115	—	18-2983	—	AQ170B	18-2816	18-2814	18-2812	MB18	—	18-2983	—
AQ115A	18-2980	—	18-2965	AQ170C	18-2817	18-2814	18-2811	MB20	—	18-2983	—
AQ115B,C	—	18-2982	18-2966	AQD2B	18-2985	—	18-3833	MB20A	18-2981	—	—
AQ120A	—	18-2983	—	B20 (0.8MM)	—	—	18-2965	MB20B	18-2980	—	18-2965
AQ120B	18-2998	18-2818	18-2968	B20 (1.2MM)	—	—	18-2966	MB20C	18-2982	—	18-2966
AQ125A	18-2998	18-2818	18-2968	B21	—	—	18-2968	MD11C,D	—	—	18-3834
AQ125B	18-2813	—	18-2970	B23	—	—	18-2970	MD17C,D	—	—	18-3834
AQ130	—	18-2983	—	B30 (0.8MM)	—	—	18-2812	MD1B	—	—	—
AQ130A	18-2980	—	18-2965	B30 (1.2MM)	—	—	18-2811	MD2B	18-2985	—	—
AQ130B	—	—	—	BB30	—	18-2983	—	MD3B	—	—	—
AQ130C	18-2980	—	18-2965	BB100	—	18-2983	—	230A,B	18-2813	—	—
AQ130D	18-2982	—	18-2966	BB115A,B	—	—	—	250A,B	18-2813	—	—
AQ131A,B,C,D	18-2813	—	18-2970								

<p>PKG. OF 2</p>  <p><b>18-0876</b> <b>18-0876-9①</b> <b>FUEL PUMP GASKET</b> For GM 4.3L, 5.0L &amp; 5.7L Replaces: 3852113</p>	<p>PKG. OF 2</p>  <p><b>18-0889</b> <b>18-0889-9①</b> <b>FUEL PUMP GASKET</b> For GM 4.3L, 5.0L &amp; 5.7L Replaces: 3852095</p>	<p>PKG. OF 2</p>  <p><b>18-2989</b> <b>18-2989-9①</b> <b>CARB MOUNTING GASKET</b> Replaces: 824677 AQ115, 125A, B, 130C, D, 131A, 145A, B, 151A, B, 170, 171A</p>	<p>PKG. OF 2</p>  <p><b>18-0398</b> <b>18-0398-9①</b> <b>THERMOSTAT GASKET</b> Replaces: 835417</p>
<p>PKG. OF 2</p>  <p><b>18-2933</b> <b>18-2933-9①</b> <b>THERMOSTAT GASKET</b> Replaces: 416033, 1317466 Used with most Volvo thermostats (Except AQ175, V-8, MD1A)</p>	<p>PKG. OF 2</p>  <p><b>18-2858</b> <b>18-2858-9①</b> <b>THERMOSTAT HOUSING COVER GASKET</b> Replaces: 3852127 For: 3.0L GS, GL, GLM, GLP, GSM, GSP</p>	<p>PKG. OF 2</p>  <p><b>18-0164</b> <b>18-0164-9①</b> <b>THERMOSTAT HOUSING GASKET</b> Replaces: 3852096 For: 3.0L GS, GL</p>	<p>PKG. OF 2</p>  <p><b>18-0929</b> <b>18-0929-9①</b> <b>THERMOSTAT GASKET</b> For: 3.0L GS, GL</p>
 <p><b>18-0183</b> <b>EXHAUST MANIFOLD GASKET</b> Replaces: 3853742, 3852455</p>	 <p><b>18-0680</b> <b>EXHAUST MANIFOLD GASKET</b> Replaces: 3853256</p>	 <p><b>18-0418</b> <b>EXHAUST MANIFOLD GASKET</b> Replaces: 3852472 For: Volvo 7.4L GL, GI, GSI, 8.2L GL, GI, GSI</p>	<p>PKG. OF 2</p>  <p><b>18-2909</b> <b>18-2909-9①</b> <b>EXHAUST MANIFOLD GASKET</b> Replaces: 856116, 3853412 For: Volvo 4.3GL, GS, GI, GXI, OSI</p>
 <p><b>18-2971</b> <b>EXHAUST MANIFOLD GASKET</b> Replaces: 856039, 835908 AQ200, 225, 260, 271, 290, 311</p>	 <p><b>18-2925</b> <b>EXHAUST MANIFOLD GASKET</b> Replaces: 461092 (Old), 1378913 AQ165, 170B, BB165, 170 6 Cyl.</p>	 <p><b>18-2922</b> <b>EXHAUST MANIFOLD GASKET</b> Replaces: 418870 (Old), 1378911 AQ90, 95, 100, 105, 110, 115, 120, 120A, 130, BB30, 100, 115, MB18, 20 4Cyl.</p>	 <p><b>18-2815</b> <b>PUSH ROD COVER GASKET</b> Replaces: 3852692 For: 3.0L</p>
 <p><b>18-1231</b> <b>INTAKE GASKET</b> Replaces: 3854095 For: Volvo 7.4L GL, GI, GSI, 8.2L GL</p>	<p>PKG. OF 2</p>  <p><b>18-2995</b> <b>18-2995-9①</b> <b>HEAT EXCHANGE GASKET</b> Replaces: 856037 AQ120B, 125A, B, 140A, 145A,B</p>	 <p><b>18-2928</b> <b>EXHAUST MANIFOLD GASKET</b> Replaces: 824633, 856044 AQ105, 115, 130, BB115, MB20 4 Cyl.</p>	 <p><b>18-2930</b> <b>EXHAUST MANIFOLD GASKET</b> Replaces: 1266796 (Old), 1378879 AQ125A, B, 145A, B, 131A, 151A, B, 120B, 140A</p>

SEE PAGES 166-167 FOR OUR COMPLETE LINE OF GASKET SEALANTS

① Priced per Package

<p>PKG. OF 2</p>  <p><b>18-2949</b> <b>18-2949-9</b>① <b>EXHAUST MANIFOLD GASKET</b> Replaces: 835966, 856034 AQ200, 225, 260, 271, 290, 311 V-8</p>	<p>PKG. OF 4</p>  <p><b>18-2991</b> <b>18-2991-9</b>① <b>EXHAUST MANIFOLD GASKET</b> Replaces: 855967, 855383 AQ120B, 125A, B, 131, 140, 145, 151, B21, B23</p>	 <p><b>18-0311</b> <b>VALVE COVER GASKET</b> Replaces: 3854942 For: 4.3 Litre 262 CID</p>	 <p><b>18-0664</b> <b>VALVE COVER GASKET</b> Replaces: 3852687 For: GM 305/350, 5.0 &amp; 5.7L</p>
 <p><b>18-0347</b> <b>VALVE COVER GASKET</b> Replaces: 3852693 For: GM 153 &amp; 181 CID (2.5L &amp; 3.0L)</p>	 <p><b>18-0352</b> <b>VALVE COVER GASKET</b> Replaces: 3852818 For: Ford 302/351 CID (5.0L &amp; 5.8L)</p>	 <p><b>18-2923</b> <b>VALVE COVER GASKET</b> Replaces: 419678 AQ105, 115, 120, 130, BB115, MB20 4 Cyl.</p>	 <p><b>18-2924</b> <b>VALVE COVER GASKET</b> Replaces: 430039 AQ165, 170, BB165, 170 6 Cyl.</p>
 <p><b>18-2927</b> <b>VALVE COVER GASKET</b> Replaces: 463999 (Old), 1378909 AQ120B, 125A, 140A, 145A, BB140, 145A 4Cyl.</p>	 <p><b>18-2972</b> <b>VALVE COVER GASKET</b> Replaces: 1378870 AQ125B, 145B, 131A, 151A, B</p>	 <p><b>18-2926</b> <b>OIL PAN GASKET</b> Replaces: 463587 (Old), 1378864 AQ90, 95, 100, 105, 110, 115, 120, 120B, 125A, B, 130, 131A, 140A, 145A, B, 151A, B, 171A</p>	 <p><b>18-0307</b> <b>OIL PAN GASKET</b> Replaces: 861250 Fits: D30, D31, D32, AD300A, AQAD30A, MD30A, TAMD30A, TMD30A, AD31A, AD31B, AD31D, AD31L-A, AD31P-A, AD31XD, AQAD31A, MD31A, TAMD31A, TAMD31B, TAMD31D, TAMD31L-A, TAM- D31M-A, TAMD31P-A, TMD31A, TMD31B, TMD31D, TMD31L-A, KAD32P-A</p>
 <p><b>18-0310</b> <b>OIL PAN GASKET</b> Replaces: 861251 Fits: D40, D41, D42, D43, D44, D300, AD40A, AQAD40A, AQAD40B, AQD40A, MD40A, TAMD40A, TAMD40B, TMD40A, TMD40B, TMD40C, AD41A, AD41B, AD41D, AD41L-A, AD41P-A, AQAD41A, D41A, D41B, D41D, D41L-A, TAMD41A, TAMD41B, TAMD41D, TAMD41H-A, TAMD41L-A, TAMD41M-A, TAMD41P-A, TMD41A, TMD41B, TMD41D, TMD41L-A, KAD42A, KAD42B, KAD42P-A, KAMD42A, KAMD42B, KAMD42P-A, TAMD42B, TAMD42WJ-A, KAD43P-A, KAMD43P-A, KAD44P-A, KAD44P-B, KAD44P-C, KAMD44P-C, KAMD44P-B, KAMD44P-C, KAD300, KAMD300A</p>	 <p><b>18-1237</b> <b>OIL PAN GASKET</b> Replaces: 3856138</p>	 <p><b>18-1239</b> <b>OIL PAN GASKET</b> Replaces: 3853343 For: Volvo 3.0L</p>	 <p><b>18-0405</b> <b>OIL PAN GASKET</b> Replaces: 3852655 For: Volvo 4.3L</p>
 <p><b>18-1232</b> <b>OIL PAN GASKET</b> Replaces: 3853510 For: Volvo 7.4L GL, GI, GSI, 8.2L GL</p>	 <p><b>18-0903</b> <b>WATER PUMP GASKET</b> Replaces: 3853361 454 CID</p>	 <p><b>18-0327</b> <b>WATER PUMP GASKET</b> Replaces: 3853342 4 &amp; 6 Cyl.</p>	<p>PKG. OF 2</p>  <p><b>18-0891</b> <b>18-0891-9</b>① <b>WATER PUMP MOUNTING GASKET</b> Replaces: 3852477 For: GM 4.3L, 5.0L &amp; 5.8L</p>

① Priced per Package

<p>PKG. OF 2</p>  <p><b>18-0893</b> <b>18-0893-9①</b> <b>WATER PUMP BACK-IN PLATE GASKET</b> Replaces: 3850595 GM 4.3L, 5.0L &amp; 5.7L</p>	 <p><b>18-0147</b> <b>WATER PUMP GASKET For Ford V-8</b> Replaces: 3852824</p>	<p>PKG. OF 2</p>  <p><b>18-2979</b> <b>18-2979-9①</b> <b>WATER PUMP GASKET</b> Replaces: 1378906 AQ120B, 125A, 140A, 145A</p>	
 <p><b>18-0468</b> <b>TIMING COVER GASKET</b> Replaces: 3852654, 3853512 GM 4.3L, 5.0L &amp; 5.7L</p>	<p>PKG. OF 2</p>  <p><b>18-0887</b> <b>18-0887-9①</b> <b>TIMING COVER GASKET</b> Replaces: 3852691 4 &amp; 6 Cyl.</p>	 <p><b>18-25250</b> <b>SEALING RING</b> Replaces: 3863085 Fits: Volvo SX-A/DPS-A (2007 &amp; Up)</p>	 <p><b>18-25251</b> <b>SEALING RING</b> Replaces: 853868 Fits: Volvo SX Thru 2006</p>
<p>PKG. OF 2</p>  <p><b>18-2519</b> <b>18-2519-9①</b> <b>SEAL RING</b> Replaces: 831622 For cooling water pipe 120B, 125A, B, 131A, 140A, 145A, B, 151A, B, 171A</p>	<p>PKG. OF 5</p>  <p><b>18-2525</b> <b>18-2525-9①</b> <b>SEAL RING</b> Replaces: 430018 Circulation pump to cylinder head AQ165A, 170A, B, C</p>	<p>PKG. OF 5</p>  <p><b>18-2526</b> <b>18-2526-9①</b> <b>SEAL RING</b> Replaces: 430172 Circulation pump to cylinder head AQ165A, 170A, B, C</p>	<p>PKG. OF 5</p>  <p><b>18-2527</b> <b>18-2527-9①</b> <b>SEAL RING</b> Replaces: 831617 For cooling water pipe AQ165A, 170A, B, C, MD21A (S/N MD-103387 &amp; UP), MD21B</p>
<p>PKG. OF 5</p>  <p><b>18-2528</b> <b>18-2528-9①</b> <b>SUPPORT RING</b> Replaces: 831891 AQ120B, 125A, B, 140A, 145A, B</p>	<p>PKG. OF 5</p>  <p><b>18-2529</b> <b>18-2529-9①</b> <b>SEAL RING</b> Replaces: 831892 AQ120B, 125A, B, 140A, 145A, B</p>	 <p><b>18-4259</b> <b>WASHER</b> Replaces: 804261</p>	<p>PKG. OF 5</p>  <p><b>18-2530</b> <b>18-2530-9①</b> <b>SEAL RING</b> Replaces: 1336255, 3547991 Circulation pump to cylinder head AQ120B, 125A, B, 131A, 140A, 145A, B, 151A, B, 171A</p>
<p>PKG. OF 2</p>  <p><b>18-2934</b> <b>18-2934-9①</b> <b>RUBBER SEAL</b> Replaces: 829714 AQ90, 95, 100, 105, 110, 115, 120, 130, MD5A, B, C, 7A, B, 11D, MD2001, 2002, 2003T</p>	<p>PKG. OF 2</p>  <p><b>18-2935</b> <b>18-2935-9①</b> <b>RUBBER SEAL</b> Replaces: 418411 AQ90, 95, 100, 105, 110, 115, 120, 130, MB18, 20, BB30, 100, MD11C, D, 17C, D, MD2001, 2002, 2003, 2003T</p>	<p>PKG. OF 2</p>  <p><b>18-2936</b> <b>18-2936-9①</b> <b>RUBBER SEAL</b> Replaces: 418445 AQ90, 95, 100, 105, 110, 115, 120, 130, MB18, 20, BB30, 100, MD11C, D, 17C, D, 2001, 2002, 2003, 2003T</p>	<p>PKG. OF 2</p>  <p><b>18-2937</b> <b>18-2937-9①</b> <b>RUBBER SEAL</b> Replaces: 418412 AQ90, 95, 100, 110, 120B, 125A, B, 131A, 140A, 145A, B, 151A, B, 165A, 170, 171A, MD21A, B</p>

① Priced per Package

<p>PKG. OF 5</p>  <p><b>18-2994</b> <b>18-2994-9</b>① <b>RUBBER SEAL</b> Replaces: 430020 AQ120B, 125A, B, 131A, 140A, 145A, B, 151A, B, 171A</p>	<p>PKG. OF 5</p>  <p><b>18-2996</b> <b>18-2996-9</b>① <b>OUTDRIVE SEAL</b> Replaces: 3852560 3.0L GL, GS, 4.3L GL, GS, GI, 5.0L FL, FI, 5.7L GL, GI, 5.8L FL, FI, FSI</p>	<p>PKG. OF 2</p>  <p><b>18-0322</b> <b>18-0322-9</b>① <b>REAR SEAL GASKET</b> Replaces: 3852656 GM 5.0L &amp; 5.7L</p>	<p>PKG. OF 2</p>  <p><b>18-2929</b> <b>18-2929-9</b>① <b>COVER PLATE GASKET</b> Replaces: 856028 AQ105, 115, 130, BB115, MB20</p>
<p>PKG. OF 2</p>  <p><b>18-2939</b> <b>18-2939-9</b>① <b>RUBBER SEAL</b> Replaces: 814356 AQ200, 250, 270, 275, 280, 290</p>	<p>PKG. OF 2</p>  <p><b>18-0874</b> <b>18-0874-9</b>① <b>DISTRIBUTOR GASKET</b> For GM V6 &amp; V8 Replaces: 3852109</p>	<p>PKG. OF 2</p>  <p><b>18-4431</b> <b>18-4431-9</b>① <b>EXHAUST ELBOW GASKET</b> Replaces: 3850496 Late Model Volvo Applications</p>	
<p>PKG. OF 2</p>  <p><b>18-2990</b> <b>18-2990-9</b>① <b>UPPER GEAR HOUSING GASKET</b> Replaces: 832669 AQ270, 275, 280, 290</p>	<p>PKG. OF 2</p>  <p><b>18-2199</b> <b>SHORT YOKE SPACER</b> Replaces: 832675 AQ270, 275, 280, 290</p>	<p>PKG. OF 2</p>  <p><b>18-2945</b> <b>18-29451-9</b>① (PKG. OF 50) <b>DRAIN SCREW GASKET</b> For: use with 18-2944 drain screw</p>	
 <p><b>18-2432</b> <b>POWER TRIM HOSE</b> Replaces: 873228 For: DP, DPX</p>	 <p><b>18-2433</b> <b>POWER TRIM HOSE</b> Replaces: 873229 For: DP, DPX</p>	 <p><b>18-21751</b> <b>ENGINE COUPLER</b> Replaces: 3853962-3 Fits: 2.5L (1986), 3.0L (1986-90), 4.3L, 5.0L, 5.7L (1986) KW &amp; KWB suffix only, 7.4L (1990-98), 8.2L (1992-93, 1998)</p>	
 <p><b>18-21752-1</b> <b>ENGINE COUPLER</b> Replaces: 3858437-1 Fits: 4.3L (1986-Current), 5.0L (1986-88, 1998-Current), 5.7 (1986-92, 1994, 1996-Current)</p>	 <p><b>18-21753</b> <b>ENGINE COUPLER</b> Replaces: 985727, 3853862-5 Fits: Ford Engines 5.0L &amp; 5.8L (1989-96)</p>	 <p><b>18-2194</b> <b>TRIM FIN</b> Replaces: 851452, 854040</p>	

① Priced per Package



**18-6456  
IDLER PULLEY**  
Replaces: 855507  
Fits:251A, AQ171A, AQ171C



**18-9096  
TRAWLING CLIP**  
Volvo 3847547  
Fits: Volvo SX-A, DPS-A (2007-Up)



**18-9098  
TRAWLING CLIPS**  
Replaces: 174448  
Set of 2  
For all SX Models thru 2006

Display Package



**18-2772-1  
TRANSOM  
SEAL KIT**  
For: SX Drives

— CONTAINS —

Part #	Description	O.E. #	Qty.
18-2100	Gimbal Bearing	3853807	1
18-2765	Bellows	3854127	1
18-1074	Bellows	3850426-2	1
18-2996	Seal	3852560, 911823	1
18-7315	Hose Clamp	853012-3	1



**STAINLESS STEEL CLAMPS**

Part #	Sizes	O.E. #
<b>18-7300</b> ① ②	50MM	—
<b>18-7306</b> ① ②	38MM	853548
<b>18-7314</b>	—	3852604
<b>18-7315</b>	112MM	853012



**18-2744  
DRIVE BELLOWS KIT**  
Replaces: 875826, 876294  
(with ridge)  
AQ200, 250, 270, 270T, 275, 280, 280T,  
PT, 290 DP UNIT: 280, 290



**18-2755  
DRIVE BELLOWS KIT**  
Replaces: 875827  
SAIL DRIVE: 100S, AQ DRIVE: 100, 100B



**18-2757  
EXHAUST  
BELLOWS KIT**  
with flapper valve  
Replaces: 875828, 876633  
AQ175, 280, 280DP, T, PT, AQD40,  
AQAD40, V-8



**18-2758  
EXHAUST  
BELLOWS KIT**  
Replaces: 875848, 876631  
AQ200, 250, 270, 275, 280, 280DP,  
290, 290DP



**18-1074  
EXHAUST BELLOWS**  
Replaces: 3850426  
For: SX Drives includes 302, 432,  
434, 502, 572, 584, 744 (1994-98)  
Uses 18-7314 Clamp



**18-2765  
U-JOINT BELLOWS**  
Replaces: 3854127  
For: DP-S, SX



**18-2766  
EXHAUST HOSE**  
Replaces: 834751  
(I.D. 95MM, LENGTH 160 MM)  
V-8

① This product is priced per piece. To order priced per package, please add -9 to the part number.  
② Priced per Package



**18-6523  
SPRING SET**

For reverse tilt lock: Fits: AQ250, 270, 275, 275A, 280, 280DP, 280L, 285A, 290, 290A, 290DP, SP-A, SP-A/MT, SP-A1, SP-A2, DP-A, DP-A1, DP-A2, DP-B, DP-B1



**18-0184  
RUBBER RING**

Replaces: 804190  
For clamp ring: Fits: 230A/SP-A/MT, 250A/SP-A/MT, 500A, 501A, 571A, 740A, AQ100, AQ105, AQ110, AQ115A, AQ110B, AQ120A, AQ120B, AQ125A/B, AQ130A/B, AQ131A/D, AQ175A, AQ190A, AQ200A/C/D/F, AQ210A, AQ211A, AQ225A/B/C/D/E/F, AQ231A/B, AQ240A, AQ255A/B, AQ260A/B, AQ271A/B/C/D, AQ280A, AQ290A, AQ311A/B, AQ60F, AQ80, AQ90, AQ95, AQD19, AQD29A, AQD32A



**18-8368  
RUBBER RING**

Replaces: 813967  
For clamp ring: 230A/SP-A/SP, A1, 230B, 250A/B, 251A, 430A/B, 431A/B, 432A, 434A, 500B, 501B, 570A, 572A, 740B, AD31A/B/D/XD, AD40B, AD41A/B/D, AQ100, AQ105, AQ110, AQ115A/B, AQ130A/B, AQ131B/C, AQ140A, AQ145A/B, AQ151A/B/C, AQ171A/C, AQ205A, AQ60F, AQ90, AQ95, AQAD30A, AQAD31A, AQAD40A/B, AQAD41A, AQD19, AQD21A/B, AQD40A, D41A/B/D, KAD32, KAD42A/B/P, KAD43P, KAD44P, KAMD42A, TAMD41A



**HEAVY DUTY U-JOINTS**

Part #	O.E. #	Application
18-2104	897707, 853255	AQ200,250,270, 280,290 (Rockwell)
18-2174	3850812	3.0L GS, GL, 4.3L GL, GS, GI, 5.0L GL, GI, 5.7L GL, GI, 5.8L FL, FI, FSI



**18-2100  
LINK BELT  
GIMBAL BEARING**

Replaces: 3853807  
Fits: OMC/Volvo- 3.0L, 4.3L, 5.0L, 5.7L, 7.4L (1994-1998), 5.8L (1994-1996), 8.2L(1998)



**18-2337  
YOKE**

Replaces: 3850814  
Fits: 3.0L GS, GL, 4.3L GS, GL, GI, 5.0L FL, FI, 5.7L GL, GI, 5.8L FL, FI, FSI



**18-2146  
UNIVERSAL U-JOINT ASSEMBLY**  
Replaces: 3850815



**18-2339  
U-JOINT ASSEMBLY**  
Replaces: 3852384



**18-2128  
CENTER SOCKET**  
Replaces: 3850813, 912213

Drive Model	U-joint Assy. #	O.E. U-joint Assy. #	Long Yoke #	O.E. Long Yoke #	Short Yoke #	O.E.Short Yoke #	Double Yoke #	O.E. Double Yoke #
SX, DP-SM	18-2339	3852384	18-2146	3850815	18-2337	3850814	18-2128	3850813



**18-4204  
PLASTIC BUSHING**  
Replaces: 826341, 876278  
AQ200, 250, 270, 275, 280, 280DP,290DP,  
**NOT FOR 270T, 280T, AND 290**



**18-2366  
LOWER  
GEARCASE SEAL**  
Replaces: 876279  
290, 290A, 290DP, SP-A, SP-A1 & SP-A2



**18-4205  
PLASTIC BUSHING**  
Replaces: 832820  
A270T, 280T



**18-4206  
STERNDRIVE COVER**  
Replaces: 832570  
AQ200, 250, 270, 275, 280, 290



**FISH LINE  
PROTECTOR SPACER**

Part #	O.E. #	Application
18-4208	839423	AQ280, 290
18-4209	839534	AQ250, 270, 275
18-4234	832965	AQ110S, 200



**18-4210  
PROP CONE**  
Replaces: 850785, 854045  
AQ200, 250, 270, 270T, 275, 280, 280T, 280PT, 290



**18-4211  
PLASTIC WASHER**  
Replaces: 850888



**18-3730  
LOCK NUT**  
Replaces: 3852648-9  
For: SX Drives





**18-4212  
PROP CONE SCREW**  
Replaces: 850889  
(5/16" — 18)



**18-4213  
SPACER**  
Replaces: 851261,  
854047  
AQ275, 280, 290



**18-4214  
LOCKING WASHER**  
Replaces: 897367  
AQ Drive Units: 200, 250,  
270, 270T (TID UTF) 275, 280,  
280T, 280PT (TID UTF)



**18-4215  
COVER SCREW**  
Replaces: 941816  
(1/4" — 20)



**18-2153  
SETTING PIVOT PIN**  
Replaces: 814301  
AQ200, 250, 270, 275, 280



**18-4254  
PRESSURE PLATE**  
Replaces: 814219

② **18-3733D** 



**18-3733  
PROP NUT KIT**  
For: SX Cobra  
— Contains —

Part #	Description	Qty.
18-4194	Spacer	1
18-3708-1	Nut & Keeper	1
18-3741	Cotter Pin	1



**18-4194  
PROP SPACER**  
Replaces: 3852350  
For: Lower gearcase models SX-M (1994)



**18-3708-1  
PROP NUT & KEEPER**  
Replaces: 3850984

PKG. OF 10



**18-3744  
18-3744-9①  
COTTER PIN**  
Replaces: 3852255  
For: XDP, MDSSL, MD22P, TMD22,  
TMD22P, TAMD22P, PJX, SX, DPS,  
DP, 3.0L GS, GL, 4.3L GL, GS, GI,  
5.0L FL, FI, 5.7L GL, GI, 5.8L FL, FI, FSI

PKG. OF 3



**18-3745  
18-3745-9①  
COTTER PIN**  
Replaces: 17253-6

PKG. OF 5



**18-4238  
18-4238-9①  
LOCK CATCH SCREW**  
For Stern Drive Cover 18-4206  
Replaces: 943218  
AQ200, 250, 270, 275, 280, 290



**18-4239  
LOCK CATCH**  
For Stern Drive Cover 18-4206  
Replaces: 897873  
AQ200, 250, 270, 275, 280, 290

PKG. OF 5



**18-4241  
18-4241-9①  
ROLL PIN**  
Replaces: 951924  
AQ200, 250, 270, 275, 280, 290



**18-1501  
DETENT BALL**  
Replaces: 3852023  
For: 3.0L GS, GL, 4.3L GL, GS, GI,  
5.0L FL, FI, 5.7L GL, GI, 5.8L FL, FI, FSI

PKG. OF 5



**18-3722  
18-3722-9①  
STAINLESS STEEL LOCKNUT**  
Replaces: 3852005  
For: PJX, SX, DPS, DP, DPX, 3.0L GL, GS,  
4.3L GL, GS, GI, 5.0L FL, FI, 5.7L GL, GI,  
5.8L FL, FI, FSI, 7.4L GL, GI, GSI, 8.2L GL



**18-0549  
PLUG OFF CAP**  
Replaces: 3852476  
For: 4.3L GL, GS, GI, GSI, 5.0L FL, FI, 5.7L GL,  
GI, 5.8L FL, FI, FSI, 7.4L GL, GI, GSI, 8.3L GI,  
GSI, GXI, 8.2L GL, GSI



**18-2138  
PIVOT PIN BEARING**  
Replaces: 3852544  
For: 3.0L GS, GL, 4.3L GL, GS, GI,  
5.0L FL, FI, 5.7L GL, GI, 5.8L FL, FI, FSI

① Priced per Package  
② Items ending in "D" are Display Packaged - Regular number is Non-Display

Zinc is for saltwater only applications.  
 Magnesium is for fresh water only applications.  
 Aluminum is for brackish water, or if boat is used in both fresh and salt environments.



③ 18-6123Z  
**ANODE**  
 Replaces: 873395  
 Transom Shield



③ 18-6124Z  
**ANODE**  
 Replaces: 872793  
 DPS Steering Arm



① 18-6125A  
 ② 18-6125M  
 ③ 18-6125Z  
**TRANSOM PLATE**  
 Replaces:  
 3586461 (Alumuminum)  
 3855610 (Magnesium)  
 3854130 (Zinc)



① 18-6126A  
 ② 18-6126M  
 ③ 18-6126Z  
**TRANSOM ANODE**  
 (with bolt)  
 Replaces:  
 3888816 (Alumuminum)  
 3888818 (Magnesium)  
 3888817 (Zinc)  
 SX-A, DPS-A, DPS-A Oxi



① 18-6127A  
 ② 18-6127M  
 ③ 18-6127Z  
**TRANSOM ANODE**  
 (with bolt)  
 Replaces:  
 3888813 (Alumuminum)  
 3888815 (Magnesium)  
 3888814 (Zinc)  
 SX-A, DPS-A, DPS-A Oxi



③ 18-6000  
 ① 18-6000A  
 ② 18-6104  
**ANODE**  
 Replaces: 832598,  
 873179  
 For 200, 250, 250C, 250D, 270,  
 270B, 270C, 270D, 275, 280,  
 280C, 280D, 280DP, 280L, 280PT



③ 18-6001  
**ANODE**  
 Replaces: 838929  
 AQ200 (For shield), MD19, 21,  
 27, 29, 32, 2003, AQ30, 31, 40, 41  
 For Fresh Water Cooler



③ 18-6004  
 ① 18-6004A  
 ② 18-6105  
**ANODE**  
 Replaces: 852835,  
 873178  
 For 290, 290A, 290ADP, 290B



③ 18-6005  
**ANODE**  
 Replaces: 875805  
 AQ250, 270, 270T, 275



③ 18-6009  
 ① 18-6009A  
**ANODE**  
 Replaces: 875815



③ 18-6028  
 ① 18-6028A  
 ② 18-6102  
**ANODE**  
 Replaces: 3855411, 984513  
 (18-6028), 3863193 (18-6028A),  
 3854412 (18-6102)  
 For use on Gearcases: 2.3L (1987-90), 2.6L/  
 3.5L/4.6L (1989), 3.0L/4.3L/5.0L/5.8L (1987-  
 93), 5.7L (1987-92), 7.4L (1987-88)



③ 18-6010  
 ① 18-6010A  
 ② 18-6106  
**ANODE**  
 Replaces: 875821  
 280DP, 290DP



**NEW**

**18-6130**  
**ANODE**  
 Replaces: Volvo  
 Fits: Volvo IPS Drives



**NEW**

**18-6131**  
**ANODE**  
 Replaces: Volvo  
 Fits: Volvo IPS Drives



**NEW**

**18-6128A**  
**ANODE KIT**  
 Replaces: Volvo  
 Fits: Volvo SX-A & DPS Drives



**NEW**

**18-6128M**  
**ANODE KIT**  
 Replaces: Volvo  
 Fits: Volvo SX-A & DPS Drives



**NEW**

**18-6128Z**  
**ANODE KIT**  
 Replaces: Volvo  
 Fits: Volvo SX-A & DPS Drives



**NEW**

**18-6129A**  
**ANODE KIT**  
 Replaces: Volvo  
 Fits: Volvo DPH Drives



**NEW**

**18-6129M**  
**ANODE KIT**  
 Replaces: Volvo  
 Fits: Volvo DPH Drives



**NEW**

**18-6129Z**  
**ANODE KIT**  
 Replaces: Volvo  
 Fits: Volvo DPH Drives



**NEW**

**18-1076**  
**BELLOWS**  
 Replaces: Volvo 3888916  
 Fits: Volvo SX-A & DPS-A Drives



**③ 18-6021**  
**ANODE PLUG**  
 Replaces: 838928  
 AQ30, 31, 40, 41, MD10, 21,  
 27, 29, 32, 2003



**18-2598**  
**GEAR HOUSING SEAL KIT**  
 Replaces: 3855275  
 Fits: Volvo SX Thru 2006



**18-2586**  
**UPPER UNIT SEAL KIT**  
 Replaces: 3850594  
 Fits: Volvo SX Thru 2006



**18-2726**  
**UPPER UNIT SEAL KIT**  
 Replaces: 3888917  
 Fits: Volvo SX-A/DPS-A (2007& Up)

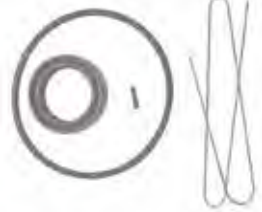

**18-3893**  
**GEAR SHIFT MECHANISM GASKET SET**  
 Fits: 275A, 280, 280DP, 280T, 285A, 290, 290A, 290DP, SP-A, SP-A/MT, SP-A1, SP-A2, SP-C, SP-C1, DP-A, DP-A1, DP-A2, DP-B, DP-B1, DP-C, DP-C1, DP-D, DP-D1, DP-E, DP-G, DPX, DPX-S, XDP-B



**18-2597  
UPPER GEAR  
UNIT SEAL KIT**

For intermediate housing: Fits: 200, 250, 270, 270T, 275, 275A, 280, 280DP, 280T, 285A, 290, 290A, 290DP, SP-A, SP-A/MT, SP-A1, SP-A2, SP-C, SP-C1, DP-A, CP-A1, DP-B, DP-B1, DP-C, DP-C1, DP-D, DP-D1, DP-E, DP-G, DPX, DPX-S, DPX-S1



**18-3888  
LOWER GEAR  
UNIT SEAL KIT**

For intermediate housing: Fits: 200, 250, 270, 270T, 275, 275A, 280, 280DP, 280T, 285A, 290, 290A, 290DP, SP-A, SP-A/MT, SP-A1, SP-A2, SP-C, SP-C1, DP-A, CP-A1, DP-B, DP-B1, DP-C, DP-C1, DP-D



**18-8357  
COMPLETE  
GEARCASE SEAL KIT**  
Replaces: 875741  
For: 280DP/290DP

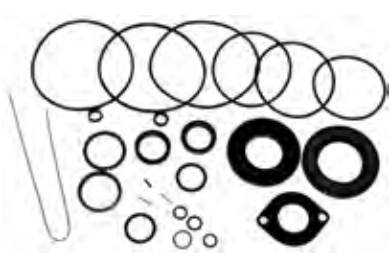

**18-8361  
UPPER SEAL KIT**  
Replaces: 576266-8  
For: AQ200-AQ290

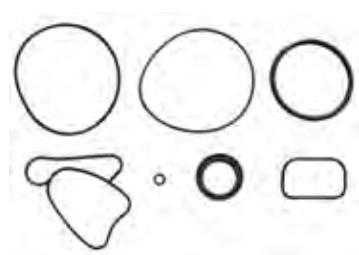

**18-2583  
LOWER UNIT SEAL KIT**  
Replace: 3888821  
Fits: SX-A Drives (2007 and UP)



**18-2584  
LOWER UNIT SEAL KIT**  
Replaces: 3888822  
Fits: DPS-A Drives (2007 and UP)

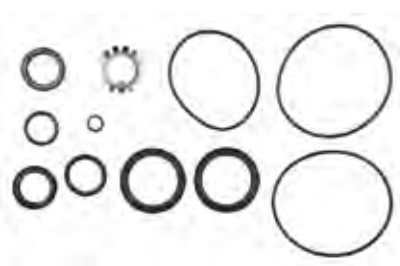

**18-8358  
LOWER UNIT SEAL KIT**  
Replaces: 876267  
For: 280DP/290DP

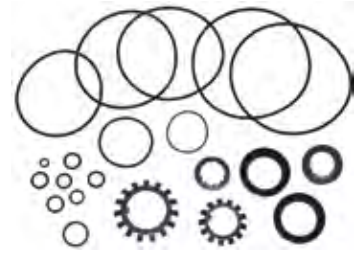

**18-8359  
LOWER GEARCASE  
SEAL KIT**  
Replaces: 876268  
For: AQ200-AQ290



**18-2791  
LOWER UNIT SEAL KIT**  
Replaces: 3850597

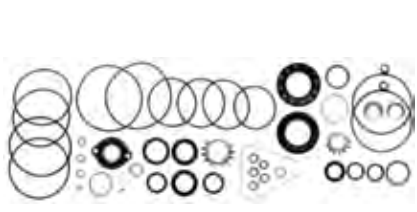

**18-2625  
STERNDRIVE GASKET KIT**  
Replaces: 875192  
AQ200, 250, 270, 275, 280, 290



**18-32882  
WATER TUBE SEAL**  
Replaces: 3852315



**OIL SEALS**

Part #	O.E. #	Dimensions (mm)		
		I.D.	O.D.	Width
18-0558	851407	44	58.33	7
18-2039	804695	13	25.4	6
18-2040	853670	45	75	8
18-2041	897426	33	45.25	7
18-2043	958838	25	35	7
18-2044	833996	12	24	7
18-2045	827247	16	28	7
18-2046	946242	35	55	10
18-2047	958860	35	62	7
18-2057	181620	34	42	4

**O-RINGS**

Part #	Pkg.	Dimensions (mm)				Part #	Pkg.	Dimensions (mm)			
		O.E. #	I.D.	Width	O.E. #			I.D.	Width		
18-7122		925095	—	—	18-7182	5	925092	55	3		
18-7154		949656	—	—	18-7183	5	925093	69.5	3		
18-7102	5	3852073	.430	.065	18-7184	5	925256	79	3		
18-7116		3852045	.360	.10	18-7186	5	925259	102	3		
18-7135		3852089	.750	.135	18-7187	5	925261	106	3		
18-7141	5	3852165	.180	.065	18-7188	5	955983	9.1	1.6		
18-7143	5	3852169	1.310	.100	18-7190	5	925065	34	3		
18-7149	5	955989	15	1.5	18-7192	5	955995	25.1	1.6		
18-7162	5	3852044	2.025	.135	18-7193	5	955974	10.3	2.4		
18-7168	5	3852033	.370	.065	18-7194	5	956000	37.1	1.6		
18-7178	5	125017	23.5	3.5	18-7406	5	3852523	.250	.065		
18-7180	5	925055	11.3	2.4	18-7407	5	3852531	4.125			
18-7181	5	925091	50.5	3							

Ⓢ This product is priced per piece. To order priced per package, please add -9 to the part number.