



Ersatzteilkatalog

Mercuriser S. 582 - S. 741

SEA RAY		
MODEL NO.	S/N	YEAR
3.0L	B787205-B917529	1988
4.3L	B785483-B921276	1988
4.3LX	B785981-B922330	1988
5.7L	B784799-B917017	1988
SRX5.7L, 350 Mag	B785241-B919012	1988
SRX7.4L, 454 Mag Alpha	B785149-B924857	1988
SRX7.4L-H, 454 Mag Bravo	B721206-B919343	1988

STERN DRIVES		
MODEL NO.	S/N	YEAR
SRX7.4L, Alpha	B803866-C348032	1988
SRX7.4L-H, Bravo	B803872-B999972	1988

INBOARD ENGINES		
MODEL NO.	S/N	YEAR
5.7L	B788204-B919356	1988
7.4L	B788179-B913769	1988

RENAULT 4 CYLINDER (STERN DRIVE)		
MODEL	S/N	YEAR
60	1887079-2049044	1965-68
80	2049045-2851423	1966-69
90	2851424-3226957	1970-72

GM 4 CYLINDER (STERN DRIVE)		
MODEL	S/N	YEAR
110	1537370-2044033	1963-66
120	1666601-3377340	1964-72
120	3377341-3770649	1972-73
120	3770650-4952700	1974-77
120	4952701-5192048	1978
120	5192049-6229717	1979-82
120	6229718-6853913	1983-84
120	6853914-B531853	1985-86
120/2.5L	B531854-C853255	1987-89
140	2508261-6229717	1968-82
140/3.0L	6229718-C856558	1982-89
3.0L/LX	C856559-UP	1990-UP

MERCURY MARINE 4 CYLINDER (STERN DRIVE)		
MODEL	S/N	YEAR
470 (2bbl.)	4208730-5520114	1976-79
470 (2bbl.)	5520115-6218036	1980-82
470 (2bbl.)	6218037-6916778	1983-84
170 (2bbl.)	6916779-UP	1985-86
165/3.7L (2bbl.)	6916779-UP	1987-89
485 (2bbl.)	5685394-6218036	1980-82
488 (4bbl.)	6170297-6916778	1983-84
190 (4bbl.)	6916779-UP	1985-86
180/3.7LX (4bbl.)	6916779-UP	1987-89

GM INLINE 6 CYLINDER (STERN DRIVE)		
MODEL	S/N	YEAR
140	1538930-1725960	1963
150	1666495-2048046	1964-66
160	2048022-2770031	1967-69
165	2770032-5178958	1970-78
165	5178959-5813433	1979-81
200	2453769-2712072	1969

GM V6 (STERN DRIVE)		
MODEL	S/N	YEAR
185 (4bbl.)	6330183-6919655	1983-84
185 (2bbl.)	A331455-B527954	1985-87
175/4.3L (2bbl.)	B527955-D714106	1987-92
4.3L (GEN II)(2bbl.)	D714107-F000877	1992-93
4.3L (GEN II)(2bbl.)	F000878-F601126	1993-95
4.3L (GEN II)(2bbl.)	F601127-F000878	1996
4.3LX (GEN+)(2bbl.)	F803000-K999999	1996-97
4.3L (GEN+)(2bbl.)	L010044-UP	1998-UP
4.3L EFI (GEN+)(TBI)	L012009-UP	1998-UP
205 (4bbl.)	A331455-B527954	1985-87
205/4.3LX (4bbl.)	B527955-D714369	1987-91
4.3LX (GEN II)(4bbl.)	D714370-F001219	1992-93
4.3LX (GEN II)(4bbl.)	F001220-F601126	1993-95
4.3LX (GEN II)(4bbl.)	F601127-F802999	1996
4.3LXH (GEN+)(4bbl.)	F803114-UP	1996-97
4.3LH(GEN+)(4bbl.)	L010044-UP	1998
262 Mag. (TBI)(GEN+)	F803800-K999999	1996-97

FORD V8 (STERN DRIVE)		
MODEL	S/N	YEAR
888 (2bbl.)	3108723-4887829	1971-77
215 (4bbl.)	2781153-3385720	1970-72
225 (4bbl.)	3385721-4166999	1973-74

FORD V8 (STERN DRIVE) Cont.		
MODEL	S/N	YEAR
225-S (4bbl.)	3385721-4166999	1973-74
233	4173000-4902304	1975-77
255	3258728-4175499	1971-74

GM V8 283, 327, 305 & 350 CID		
MODEL	S/N	YEAR
190	1564539-1730903	1963-64
898 (2bbl.)	4762210-6218461	1977-82
898 (2bbl.)	6218462-B525981	1983-84
200/5.0L (2bbl.)	6218462-F600999	1985-95
5.0L (2bbl.)	L015751-UP	1998-UP
5.0L EFI	L012052-L340000	1998-99
228 (4bbl.)	4765100-5170008	1977-78
228 (4bbl.)	5170009-6218461	1979-82
228 (4bbl.)	6218462-B525981	1982-84
230 (4bbl.)	6218462-B525981	1985-86
230/5.0LX (4bbl.)	B525982-F600999	1987-95
225	1539620-2694014	1963-69
250	2314301-2639854	1968-69
255	4175500-4767999	1975-76
250	4768000-4908849	1977
260/5.7L	4908850-6218461	1978-82
260/5.7L	621462-B525981	1982-86
260/5.7L	B525982-F600999	1987-95
5.7L (2bbl.)	F601000-UP	1996-98
5.7L EFI	F225560-UP	1995-UP
5.7LX (4bbl.)	F601000-K999999	1996-97
5.7LX EFI	F752400-K999999	1996-97
5.7LX Bravo EFI	F800300-K999999	1996-97
350 Mag. Alpha	A635178-B525981	1986-87
350 Mag. Alpha	B525982-F600999	1987-95
350 Mag. Alpha	F601000-K001526	1996
350 Mag. Alpha	K001527-K999999	1997
350 Mag. Alpha EFI	F800300-K999999	1996-97
350 Mag. Bravo MPI	F415189-K999999	1995-97
350 Mag. Bravo MPI (GEN +)	F602000-K999999	1996-97
350 Mag. MPI (GEN+)	L010019-UP	1998-UP
270	2851074-3385720	1969-72
280TRS	4176250-4770199	1975-76
300 Tempest	6668677-B430367	1985-86
320 (EFI)	A543604-C622418	1987-89

GM V8 427, 454, 502, 540 & 572 (STERN DRIVE)		
MODEL	S/N	YEAR
325	2278747-3780449	1969-72
330	4623115-6083144	1977-81
330	6083145-B816450	1982-87
7.4L Bravo	B771113-D603117	1988-91
7.4L Bravo (Gen.V)	D603118-F800699	1992-96
7.4L Bravo (Gen.VI)	F800700-K999999	1996-97
7.4LX Bravo (MPI)(Gen.V)	F602010-F801999	1996
7.4LX Bravo (MPI)(Gen.VI)	F802000-K999999	1996-97
7.4L MPI (Gen.VI)	L010003-UP	1998
7.4LX Bravo (TBI)(Gen.VI)	F820000-K999999	1996-97
454 Mag. Alpha	A631894-UP	1986-88
454 Mag. Bravo (Gen.V)	D805069-F304999	1992-94
454 Mag. Bravo (Gen.V)	F305000-F801699	1995-96
454 Mag. Bravo (Gen.VI)	F801700-K999999	1996-97
454 EFI (Gen.V)	F115700-F802349	1994-96
454 Mag. MPI (Gen.VI)	F802350-K999999	1996-97
454 Mag. MPI (Gen.VI)	L010029-L085399	1998
454 Mag. MPI (Gen.VI)	L085400-UP	1999-UP
370 TRS	4179554-6721527	1978-85
370 TRS	6721528-B714586	1985-87
400 TRS	4179554-B457644	1980-86
420	A398941-D937011	1987-89
425	A398941-D937011	1990-93
440 TRS	4179554-B485220	1983-86
450 (Gen.V)	F347100-F347277	1995-96
525 SC	D456000-F348963	1991-92
525 SC (Gen.V)	D456000-F348963	1992-95
525 SC (Gen.V)	F615814-F745215	1996
525 SC (Gen.VI)	F745260-UP	1996-97
390	2781129-3042731	1969-70
460 TRS	4719554-6181046	1983-86
465	C849992-F213244	1990-92
465 (Gen.V)	C849992-F213244	1992-94
500 (Gen.V)	F213293-F745159	1994-96

GM V8 427, 454, 502, 540 & 572 (STERN DRIVE) Cont.			GM MIE V8 427, 454, 482 & 502 CID (INBOARD)		
MODEL	S/N	YEAR	MODEL	S/N	YEAR
500 (Gen.VI)	F745195-L001772	1997-98	8.2L MPI (LH) Gen VI	L002450-L0086012	1998
502 Mag. Bravo	C878221-D824588	1990-92	8.2L MPI (LH) Gen VI	L0086013-UP	1999
502 Mag. Bravo (Gen.V)	D824589-F114528	1992-93	MIE 5, 6 & V8 CYLINDER DIESEL INBOARD ENGINES		
502 EFI (Gen.V)	D840650-F802599	1993-96	MODEL	HP	S/N
502 Mag.MPI (Gen.VI)	F802600-K999999	1996-97	530 D-TA	150	B993002-C539258
500 EFI	L001477-UP	1999-UP	636 D-TA	180	B993750-C696011
502 Mag.MPI (Gen.VI)	L085433-UP	1998	D183	150	C539259-D725149
600 SC	D456489-F877642	1991-92	D219	180	C696012-D850124
600 SC (Gen.V)	D456489-F877642	1992-96	D254	210	C849461-D554729
600 SC (Gen.VI)	K000227-UP	1997	D3.0L	150	D725150-UP
500 Bulldog	C577254-F745405	1990-96	D3.6L	180	D850125-UP
500 Bulldog	K000248-UP	1997	D4.2L	210	D554730-UP
575	A677429-D763716	1986-92	D7.3L	262	F060000-UP
800 SC (Gen.V)	D763836-UP	1993-96	MC 60, 80 & 90 STERN DRIVES & TRANSOM PLATES		
MCM 4,5,6 & V8 CYLINDER DIESEL STERN DRIVE ENGINE			MODEL	S/N	YEAR
MODEL	HP	S/N	60 (O)	1830753-2063740	1965-66
Rover 60	3140000F-UP	1965-67	80	2063741-2898029	1966-69
530 D-TA	150	B993000-B993492	90	2898020-3225967	1970-72
636 D-TA	180	B993500-C696047	MC I, II & III		
D183	140	B993493-D725149	MODEL	S/N	YEAR
D219	170	C696048-D850124	I	1534570-1684187	1963
D254	200	C849484-D554729	II (1.33:1)	1474909-2278488	1962-67
D3.0L	140	D725150-UP	MC I, II & III Cont.		
D3.6L	170	D850125-UP	MODEL	S/N	YEAR
D4.2L	200	D554730-UP	II (1.78:1)	2398798-2671321	1968-69
D7.3L	238	F060000-UP	III	2373127-3002613	1968-72
MERCURY MARINE MIE 4 CYLINDER (INBOARD)			III	5128065-UP	1978-UP
MODEL	S/N	YEAR	MC 1A, 1B & 1C		
470	5520115-6218036	1980-81	MODEL	S/N	YEAR
FORD MIE V8 (INBOARD)			1A, 1B & 1C	1684188-1777798	1964
MODEL	S/N	YEAR	1A, 1B & 1C (E-Z Shift)	1776349-2065189	1965-66
215	2781153-3563181	1970-72	MC 120, 140, 160 & 165		
225	3385721-4176999	1970-72	MODEL	S/N	YEAR
233	4173000-4775784	1975-76	120/140	2062141-378049	1967-73
255	3258728-4178299	1973-74	120/140	3780850-4893634	1974-77
GM MIE V8 305,327,350 CID (INBOARD)			120/140	4893635-6225576	1978-82
MODEL	S/N	YEAR	160	2065190-2763441	1967-69
198	4762210-6218461	1977	165	2763442-3780849	1970-73
228	4765100-5170008	1977-78	165	3780849-4890459	1974-77
228	5170009-5907057	1979-80	165	4890460-6268064	1978-82
230/5.0L (4bbl.)	5907058-B788151	1981-87	MC470 & 485		
225	2278647-2694014	1968	MODEL	S/N	YEAR
250	2314301-2639854	1968-69	470	4208730-4893834	1976-77
255	4175500-5907057	1975-80	470	4893835-6225576	1978-82
260/5.7L	5907058-F024999	1981-93	485	5487437-6225576	1980-82
270	2851074-3077735	1969-72	MC 888, 225S & 233		
5.7L	F025000-K999999	1994-97	MODEL	S/N	YEAR
5.7L (Gen+)	L002003-UP	1998	888	3106717-3784374	1971-73
5.7L MPI	K040300-K999999	1997	888	3784375-4782329	1974-77
350 Mag. MPI (Gen+)	L002008-L304499	1998	225S	3856268-4200499	1974
350 Mag. MPI (Gen+)	L304500-UP	1999	233	4200500-4782329	1975-77
350 Horizon	L304700-UP	1999-UP	MC 898, 228, 250 & 260		
5.7L Ski	A338533-B514626	1985-87	MODEL	S/N	YEAR
5.7L Competition Ski	B514627-F775199	1987-95	898/228	4782330-4898729	1977
5.7L Competition Ski	F775200-K040003	1996	898/228	4898730-6229157	1978-82
5.7L Competition Ski	K040004-K999999	1997	250	4791300-4898729	1977
5.7L Competition Ski	L002005-UP	1998-UP	260	4898730-6229157	1978-82
(Gen+)			MC R, MR, ALPHA ONE, ALPHA ONE SS & ALPHA ONE GEN II		
350 Mag. Ski	D505450-K999999	1991-97	MODEL	S/N	YEAR
350 Mag. EFI Ski	F215561-K999999	1994-97	R	6152230-6847029	1983-84
350 Mag. MPI Ski	F350583-F799999	1995-98	MR	6810538-A479506	1985
Black Scorpion Ski	F800000-UP	1996-98	Alpha One	A470165-UP	1986-90
GM MIE V8 427, 454, 482 & 502 CID (INBOARD)			Alpha One SS	A545004-UP	1986-89
MODEL	S/N	YEAR	Alpha One Gen II	D469859-UP	1991-UP
325	2278747-3780449	1968-74	MC BRAVO & BLACKHAWK		
330	4623115-5889913	1977-80	MODEL	S/N	YEAR
340/7.4L w/B/W MK4	5889914-UP	1981-92	Bravo One	B664190-UP	1988-UP
7.4L w/Hurth (LH) MK4	C391564-D715493	1989-92	Bravo Two	C564952-UP	1989-UP
7.4L (LH)	D715494-K999999	1992-97	Bravo Three	D763691-UP	1993-UP
7.4L MPI (LH)	F563052-K999999	1995-97	Blackhawk	F186717-UP	1994-UP
7.4L MPI (L29) Gen VI	L002006-UP	1998	MC 215E & 215H		
7.4L TBI (LH) Gen VI	F874815-K999999	1996-97	MODEL	S/N	YEAR
454 Mag. MPI Horizon	L002200-L086049	1998-99	215H	2782203-2909034	1970
454 EFI (SKI) (Gen.V)	F215800-F820099	1995-96	215E	2782203-2909034	1970-72
454 Mag. MPI (SKI)(Gen.VI)	F820100-K999999	1996-97	MC TR & TRS		
350	9780450-4623109	1974-76	MODEL	S/N	YEAR
390	2781129-2825059	1969-70	TR	3377316-3787239	1973
8.2L w/ Hurth	C878221-D857199	1990-92	TR	3787240-4794899	1974-76
8.2L (Gen.V)	D857200-F819619	1993-96	TR	4794900-5009866	1977
8.2L MPI (LH) Gen VI	F819620-K999999	1996-97	TR	5009867-UP	1978-UP
			TRS	3787240-4203749	1974-75
			TRS	4203750-4795399	1976
			TRS	4795400-UP	1977-UP



18-5291
TUNE-UP KIT
 Replaces: 808483K2
 GM V-8 engines w/Delco HEI-1998 and newer
 (except MPI engines with 555 ECM)



18-5246
TUNE-UP KIT
 Replaces: 898253T28
 For: Late model V-6, 4.3L (Alpha/Bravo)



18-5247
TUNE-UP KIT
 Replaces: 898253T29
 For: Late model V-8 (Alpha/Bravo 350
 Mag, 5.0L, & MX 6.2L)

① **18-5250D** Display Package



18-5250
TUNE-UP KIT
 Replaces: 34235T1, 34235Q1

—CONTAINS—		
Part #	O.E. #	Description
18-5311	34235	Contact Set
18-5345	33662	Condenser
18-5418	58217	Rotor

Delco 4 & 6 cyl.

① **18-5251D** Display Package



18-5251
TUNE-UP KIT

—CONTAINS—

Part #	O.E. #	Description
18-5314	391-5090	Contact Set
18-5338	391-5092	Condenser
18-5404-1	391-7057	Rotor

Mallory 8 cyl. Tall Cap



18-5252
TUNE-UP KIT

—CONTAINS—

Part #	O.E. #	Description
18-5310	33700	Contact Set
18-5344	33706	Condenser

Delco 8 cyl.



18-5253
TUNE-UP KIT

—CONTAINS—

Part #	O.E. #	Description
18-5318	58033	Contact Set
18-5346	58034, 81-64851	Condenser
18-5420	65864	Rotor

Autolite 8 cyl.

① **18-5254D** Display Package



18-5254
TUNE-UP KIT

—CONTAINS—

Part #	O.E. #	Description
18-5317	64850, 87-71831	Contact Set
18-5346	58034, 81-64851	Condenser
18-5420	65864, 78016	Rotor

Mercury 8 cyl.

① **18-5258D** Display Package



18-5258
TUNE-UP KIT

—CONTAINS—

Part #	O.E. #	Description
18-5303	392-6325	Contact Set
18-5347	392-6324	Condenser
18-5407	392-6326	Rotor

Prestolite 8 cyl.

① **18-5260D** Display Package



18-5260
TUNE-UP KIT

—CONTAINS—

Part #	O.E. #	Description
18-5303	392-6325	Contact Set
18-5345	392-6324	Condenser
18-5403	392-9767	Rotor

Prestolite 8 cyl.



18-5266
TUNE UP KIT
 Fits: Flame Thrower Distributors 18-5481, 18-5482,
 18-5483, 18-5477, 18-5478 and 18-5479



18-5267
TUNE-UP KIT

—CONTAINS—

Part #	O.E. #	Description
18-5318	58033	Contact Set
18-5346	58034, 81-64851	Condenser
18-5420	65864, 78016	Rotor
18-5389	393-4988T	Distributor Cap

Autolite V-8 - Single Point



18-5268
TUNE-UP KIT

—CONTAINS—

Part #	O.E. #	Description
18-5311	34235	Contact Set
18-5345	33662	Condenser
18-5418	58217	Rotor
18-5385	393-9459	Distributor Cap

Delco In-Line 4 - Single Point



18-5269
TUNE-UP KIT

—CONTAINS—

Part #	O.E. #	Description
18-5311	34235	Contact Set
18-5345	33662	Condenser
18-5418	58217	Rotor
18-5386	33765	Distributor Cap

Delco In-Line 6 - Single Point



18-5270
TUNE-UP KIT

—CONTAINS—

Part #	O.E. #	Description
18-5310	33700	Contact Set
18-5344	33706	Condenser
18-5384	33708	Distributor Cap

Delco V-8 - Single Point

① Items ending in "D" are Display Packaged - Regular number is Non-Display



**18-5271
TUNE-UP KIT**

—CONTAINS—

Part #	O.E. #	Description
18-5314	391-5090	Contact Set
18-5338	391-5092	Condenser
18-5404-1	391-7057, 391-5088	Rotor
18-5376	391-5075	Distributor Cap

Mallory V-8 - Single Point - Top Terminal



**18-5273
TUNE-UP KIT**

—CONTAINS—

Replaces: 805759T3 / 805759Q3

Part #	O.E. #	Description
18-5431	13524A5	Rotor
18-5395	16457A4	Distributor Cap

Mercury Thunderbolt HEI - V-8



**18-5274
TUNE-UP KIT**

—CONTAINS—

Part #	O.E. #	Description
18-5432	13524A6	Rotor
18-5396	13753A2, 815407A2	Distributor Cap

Mercury Thunderbolt HEI - V-6



**18-5275
TUNE-UP KIT**

—CONTAINS—

Part #	O.E. #	Description
18-5303	392-6325	Contact Set
18-5347	392-6324	Condenser
18-5403	392-9089	Rotor
18-5352	392-9766	Distributor Cap

Prestolite V-8 - Single Point - Screw Cap



**18-5276
TUNE-UP KIT**

—CONTAINS—

Part #	O.E. #	Description
18-5303	392-6325	Contact Set
18-5347	392-6324	Condenser
18-5403	392-9089	Rotor
18-5353	392-9086	Distributor Cap

Prestolite V-6 - Single Point - Screw Cap



**18-5277
TUNE-UP KIT**

—CONTAINS—

Part #	O.E. #	Description
18-5303	392-6325	Contact Set
18-5347	392-6324	Condenser
18-5407	392-6326	Rotor
18-5369	392-6318	Distributor Cap

Prestolite V-8 - Single Point - Clip Cap



**18-5278
TUNE-UP KIT**

Replaces: 850484T3
Delco EST - V-6



**18-5280
TUNE-UP KIT**

Replaces: 811635Q2
Delco EST - In-Line 4

—CONTAINS—

Part #	Description	O.E. #	Qty.
18-5361	Distributor Cap	811635, T3	1
18-5406	Rotor	811636, 1	1



**18-5281
TUNE-UP KIT**

Replaces: 808483Q2
Delco EST - V-8

—CONTAINS—

Part #	Description	O.E. #	Qty.
18-5354	Distributor Cap	808483	1



**18-5282
TUNE-UP KIT**

Holley, Mercury Marine -
Single Point V-8



**18-5283
TUNE-UP KIT**

For: Mallory Single Point In-Line 4



**18-5301
TUNE-UP KIT**

Replaces:
Fits: male cap v-8 flamethrower distributors



**18-5302
TUNE-UP KIT**

Replaces:
Fits: male cap v-8 flamethrower distributors



**18-5303
CONTACT SET**

Replaces: 392-898253005



**18-5310
CONTACT SET**

Replaces: 33700



**18-5311
CONTACT SET**

Replaces: 34235, 34235T



**18-5314
CONTACT SET**

Replaces: 391-5090,
391-898253004

 <p>18-5317 CONTACT SET Replaces: 64850, 87-71831</p>	 <p>18-5318 CONTACT SET Replaces: 58033, 898253007</p>	 <p>18-5338 CONDENSER Replaces: 391-5092, 391-898253001</p>	 <p>18-5344 CONDENSER Replaces: 33706</p>	 <p>18-5345 CONDENSER Replaces: 33662, 898253003</p>
 <p>18-5346 CONDENSER Replaces: 58034, 81-64851</p>	 <p>18-5347 CONDENSER Replaces: 392-6324, 392-898253002</p>	 <p>18-5402 ROTOR Replaces: 898253009 GM V-8 engines w/Delco HEI- 1998 and newer (except MPI engines with 555 ECM)</p>	 <p>18-5245 ROTOR Replaces: 884790, 898253013 For: Late model V-6, V-8 (Alpha/ Bravo 350 Mag, 5.0L, & MX 6.2L)</p>	 <p>18-5403 ROTOR Replaces: 392-9089, 392-9089T, 392-9767</p>
 <p>18-5404-1 ROTOR Replaces: 391-7057, 391-5088, 391-7057T, 391-898253029</p>	 <p>18-5405 ROTOR Replaces: 808484, 808484 1, 898253010 Use with 18-5354 Distributor Cap Fits new GM style "Module in Cap" distributors - V-8 application</p>	 <p>18-5406 ROTOR Replaces: 811636, 811636 1, 898253011 Use with 18-5361 Distributor Cap 3.0L LX</p>	 <p>18-5407 ROTOR Replaces: 392-6326, 392-6326T</p>	 <p>18-5300 ROTOR Fits: Flamethrower Distributors</p>
 <p>18-5408 ROTOR Replaces: 850485, 850485 1, 898253012 Use with 18-5362 Distributor Cap Fits new GM Style "Module in Cap" Distributors V6 Applications</p>	 <p>18-5418 ROTOR Replaces: 58217, 898253008</p>	 <p>18-5420 ROTOR Replaces: 65864, 78016</p>	 <p>18-5431 ROTOR ASSEMBLY Replaces: 13524A5, T1 V-8</p>	
 <p>18-5432 ROTOR ASSEMBLY Replaces: 13524A6 V-6</p>	 <p>18-5243 DISTRIBUTOR CAP Replaces: 888731, 898253T23 For: Late model V-6 (4.3L Alpha/Bravo)</p>	 <p>18-5244 DISTRIBUTOR CAP Replaces: 884792, 858253T22 For: Late model V-8 (Alpha/Bravo 350 Mag, 5.0L, & MX 6.2L)</p>	 <p>18-5352 DISTRIBUTOR CAP Replaces: 392-9766, Q1</p>	

 <p>18-5353 DISTRIBUTOR CAP Replaces: 392-9086, 392-9086T</p>	 <p>18-5354 DISTRIBUTOR CAP Replaces: 808483, 808483T3 Fits new GM style "Module in Cap" Distributors-V-8 applications Use 18-5405 Rotor</p>	 <p>18-5361 DISTRIBUTOR CAP Replaces: 811635, 811635T3 Use 18-5406 Rotor 3.0L LX</p>	 <p>18-5362 DISTRIBUTOR CAP Replaces: 850484, 850484T, 850484T2 Fits new GM Style "Module in Cap" Distributors - V6 Applications Use 18-5408 Rotor</p>
 <p>18-5369 DISTRIBUTOR CAP Replaces: 392-6318, 392-6318T with gasket 18-5399</p>	 <p>18-5376 DISTRIBUTOR CAP Replaces: 391-5075, 391-5075Q1</p>	 <p>18-5384 DISTRIBUTOR CAP Replaces: 33708</p>	 <p>18-5385 DISTRIBUTOR CAP Replaces: 393-9459, 393-9459Q1</p>
 <p>18-5386 DISTRIBUTOR CAP Replaces: 33765, 33765T</p>	 <p>18-5389 DISTRIBUTOR CAP Replaces: 393-4988T, 393-4988T2</p>	 <p>18-5395 DISTRIBUTOR CAP Replaces: 16457A4, 805759T, 805759T1 V-8</p>	 <p>18-5396 DISTRIBUTOR CAP Replaces: 13753A2, 815407A2 V-6</p>
 <p>18-5397 DISTRIBUTOR CAP</p>	 <p>18-5473 DISTRIBUTOR CAP Black Distributor Cap w/ Male Terminals Petronix Dsistributors</p>	 <p>18-5474 DISTRIBUTOR CAP Red Distributor Cap with Male Terminals Petronix Dsistributors</p>	<p>PKG OF 2</p>  <p>18-5399 18-5399-9① DISTRIBUTOR CAP GASKET Replaces: 392-6329</p>

FEATURES

- Oil filled for better cooling and long life
- Low resistance and improved turn ratios produces the higher voltage needed to run larger spark plug gaps for added power and better fuel economy
- More windings maximize energy and reliability over the full RPM range
- Fits existing brackets for easy installation

 <p>18-5466 HI-PERFORMANCE IGNITION COIL 1.5 ohm (oil filled), black - 8 cylinder: Flame-Thrower 40,000 volt coil.</p> <ul style="list-style-type: none"> • Designed for use with the original Ignitor Electronic Conversion Kits • Can be used with other inductive ignition systems 	 <p>18-5469 HI-PERFORMANCE IGNITION COIL 3.0 ohm (oil filled), black - 4 & 6 cylinder: Flame-Thrower 40,000 volt coil.</p> <ul style="list-style-type: none"> • Designed for use with the original Ignitor Electronic Conversion Kits • Can be used with other inductive ignition systems 	 <p>18-5472 HI-PERFORMANCE IGNITION COIL 0.6 ohm (oil filled), black - 4, 6, & 8 cylinder:Flame-Thrower 45,000 volt coil.</p> <ul style="list-style-type: none"> • Super low 0.6 ohm resistance coil designed for use with the Ignitor II Hi Performance Electronic Conversion Kits • Compatible with capacitive discharge systems
---	--	--

① Priced per Package

COIL APPLICATION BEGINS ON NEXT PAGE
CAP APPLICATION BEGINS ON PAGE 593

Part #	Description	Recommended Coil	Resistance Ohms	Part #	Description	Recommended Coil	Resistance Ohms
18-5294	Electronic Conversion Kit	18-5469	3.0	18-5286	Hi Performance Electronic Conversion Kit	18-5472	0.6
18-5295	Electronic Conversion Kit	18-5469	3.0	18-5288	Hi Performance Electronic Conversion Kit	18-5472	0.6
18-5296-2	Electronic Conversion Kit	18-5466	1.5	18-5289	Hi Performance Electronic Conversion Kit	18-5472	0.6
18-5297	Electronic Conversion Kit	18-5469	3.0	18-5290	Hi Performance Electronic Conversion Kit	18-5472	0.6
18-5298	Electronic Conversion Kit	18-5466	1.5	18-5481	Flame-Thrower Distributor	18-5472	0.6
18-5299	Electronic Conversion Kit	18-5466	1.5	18-5482	Flame-Thrower Distributor	18-5472	0.6
18-5285	Hi Performance Electronic Conversion Kit	18-5472	0.6	18-5483	Flame-Thrower Distributor	18-5472	0.6



**18-5433
IGNITION COIL**
Replaces: 38547, 32193A2, 392-806529A1, 898253T24 DELCO 1115202
(Uses External Resistor)

[Display Package](#)



**18-5438
IGNITION COIL**
Replaces: 392-7803A4, 392-805570A2 HEI



**18-5465
IGNITION COIL**
Replaces: 392-863704T ss 8M0054588 2001 and newer 4.3L, 5.0L, 5.7L & 6.2L with 555 ECM (OM300000 and up)



**18-7493
COIL**
Replaces: 392889925
For: 8.1L & 496 Mag OM315053 & UP



**18-7648
IGNITION COIL**
Replaces: 392881732



**18-5442
IGNITION COIL**
Replaces: 806673T, T1



**18-5443
IGNITION COIL**
Replaces: 817378T, 817378, 898253T27



**18-5117
IGNITION MODULE**
Replaces: GM 10482803
Fits: MCM MIE 4.3L MPI, 5.0L MPI, 350 Mag MPI and MX 6.2L MPI engines with ECM555 (2001 & Up) S/N OM300000 & Up



**18-5107-1
IGNITION MODULE**
4/6/8 cyl.
Replaces: 811637001



**18-5464
IGNITION MODULE**
Fits: Sierra 18-5481, 18-5482 and 18-5483 Billet HI-PERFORMANCE ELECTRONIC DISTRIBUTORS (except HEI/EST)



**18-5488
IGNITION MODULE**
Replacement module for Mallory electronic distributors



**18-5108
PICK UP
COIL SENSOR**
Replaces: 811639, T V4/V6/V8



**18-5116-1
IGNITION SENSOR KIT**
Replaces: 87-861780A2, Q4
For: V-6 & V-8 with Thunderbolt ignition (1981-1997) nut connectors



**18-7757
THROTTLE POSITION SENSOR**
Replaces: 803148
For: 350 Mag OL005900 & Up

- Senses current levels in the coil and adjusts the dwell to maintain peak energy throughout the entire RPM range.
- Develops, on average, 4 times more available energy between 3000 and 5000 RPM's and twice as much plug voltage as point-type systems.
- Ignition energy is sustained and coil life is increased when peak current level is reached just prior to spark.
- More stable timing.
- Use with 18-5472 "Flame Thrower II" Coil for optimum performance

**18-5285
HI-PERFORMANCE
ELECTRONIC
CONVERSION KIT**

Fits: 4 Cylinder Delco Distributors



**18-5286
HI-PERFORMANCE
ELECTRONIC
CONVERSION KIT**

Fits: 6 Cylinder Delco Distributors



**18-5288
HI-PERFORMANCE
ELECTRONIC CONVERSION KIT**

Fits: Most Prestolite V-8 Distributors with snap down cap



**18-5289
HI-PERFORMANCE
ELECTRONIC CONVERSION KIT**

Fits: Most Prestolite Distributors with screw down cap



**18-5290
HI-PERFORMANCE
ELECTRONIC CONVERSION KIT**

Fits: Most Mallory YL or YD 8 cylinder Distributors with clockwise and counter clockwise rotation



FEATURES

- Replaces point & condensers for true solid state ignition.
- Uses standard coil, cap and rotor.
- Easy to install, one-piece, 2-wire hook-up.
- Accurate to within 1/4° timing accuracy 0 to 6000 RPM range.
- Can be used with Flame Thrower 18-5466 & 18-5469.

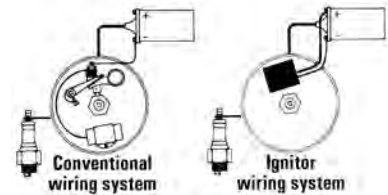

**18-5294
ELECTRONIC CONVERSION KIT**

Fits: 6 Cyl. Delco Distributors



**18-5295
ELECTRONIC CONVERSION KIT**

Fits: Most 4 Cyl. Prestolite Distributors (Except IBM7026)
For: Onan, Universal, Waukesha, Wisconsin



**18-5296-2
ELECTRONIC CONVERSION KIT**

Fits: Most Mallory YL or YD 8 cyl. Distributors with clockwise or counter clockwise rotation



① 18-5296-2D Display Package

**18-5297
ELECTRONIC CONVERSION KIT**

For 4 Cyl. GM



① 18-5297D Display Package

**18-5298
ELECTRONIC CONVERSION KIT**

(with snap down cap) For: Most Prestolite V-8 Distributors



**18-5299
ELECTRONIC CONVERSION KIT**

(with screw down cap) For: Most Prestolite V-8 Distributors
Use with 18-5403 Style Rotor



① 18-5299D Display Package

APPLICATION BEGINS ON PAGE 593

① Items ending in "D" are Display Packaged - Regular number is Non-Display



FEATURES

- Distributors feature the Ignitor II ignition module with adaptive dwell control adjusts the spark timing over the entire RPM range to maximize performance
- Upper roller bearing and oil impregnated bronze sintered bottom bushing are installed and aligned bored for accuracy for maximum durability
- Machined heat treated gear with tight tolerances insures durability and consistent timing to maximize horsepower and performance. Complete with high dielectric strength cap and rotor for years of performance

Standard Rotation

CCW Rotation

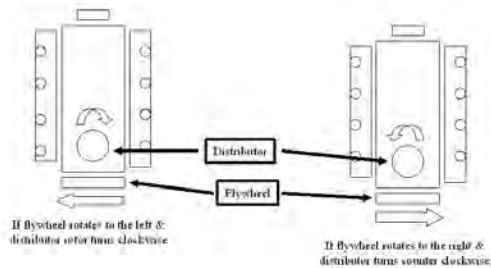

18-5481
HI-PERFORMANCE
ELECTRONIC DISTRIBUTOR
Fits: Ford V-8 351 Windsor
Replacement cap/rotor kit: 18-5266

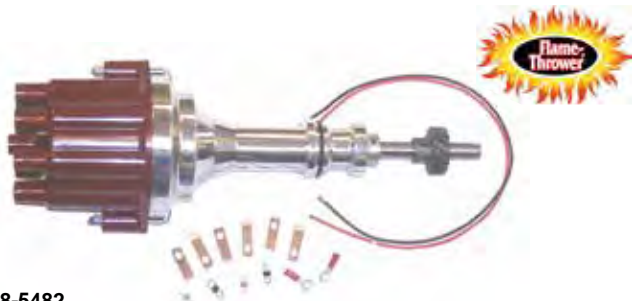

18-5482
HI-PERFORMANCE
ELECTRONIC DISTRIBUTOR
Fits: Ford V-8 351 Cleveland, 351M, 400, 429 and 460 engines
Replacement cap/rotor kit: 18-5266



18-5483
HI-PERFORMANCE
ELECTRONIC DISTRIBUTOR
Fits: Chevrolet marine small and big block engines (standard deck height)
Replacement cap/rotor kit: 18-5266



18-5477
ELECTRONIC DISTRIBUTOR
Fits: Ford 302 V-8 engines



18-5478
ELECTRONIC DISTRIBUTOR
Fits: Chrysler LA series V-8 engines



18-5479
ELECTRONIC DISTRIBUTOR
Fits: GM V-8 engines-reverse rotation



18-5480
COMPLETE IGNITION
CONVERSION KIT
Fits: GM SB & BB with Standard Deck Height
—CONTAINS—

Part #	Description
18-5472	Coil
18-8803-2	Wire Set
18-5483	Distributor



18-5470
THUNDERBOLT IV V-8 DISTRIBUTOR

Replaces: 805185A36
Fits: GM V-8 engines



18-5471
THUNDERBOLT IV V-6 DISTRIBUTOR

Replaces: 805185A37
GM V-6 engines



18-5350
DISTRIBUTOR

Replaces: 888751A03
Fits: Vortec™ V-6 4.3L MPI (2002-06)



18-5351
DISTRIBUTOR

Replaces: 884794A02
Fits: Vortec V-8 2001 and up 5.0L/ 5.7L/ 6.2L MPI engines (S/N OM300000 and up)



18-5475
DISTRIBUTOR

Replaces: 817377
FITS: 4 CYL GM W/ DELCO EST IGNITION



18-5476
DISTRIBUTOR

Replaces: 807964A1
Fits: GM V-6 engines with Delco EST ignition HEI



18-5484-1
ELECTRONIC DISTRIBUTOR

Left Hand Rotation
Replaces: Mallory YLE624AV
Late Model HEI

For V8 — 262-454 & 502 except 384/ 409 and tall block engines
• Designed as a plug-in replacement for GM-style fuel injection system distributors

—CONTAINS—

Part #	Description
18-5354	Distributor Cap
18-5405	Rotor



18-5485
ELECTRONIC DISTRIBUTOR

Right Hand Rotation
Replaces: Mallory YLE624BV
Late Model HEI

For V8 — 262-454 & 502 except 384/ 409 and tall block engines
• Designed as a plug-in replacement for GM-style fuel injection system distributors

—CONTAINS—

Part #	Description
18-5354	Distributor Cap
18-5405	Rotor



18-5486
ELECTRONIC DISTRIBUTOR

Conventional Rotation
For Chevrolet L4, 153 & 181 CID

—CONTAINS—

Part #	Description
18-5397	Distributor Cap
18-5488	Module
18-5404-1	Rotor



18-5487
ELECTRONIC DISTRIBUTOR

Conventional Rotation
For Chevrolet L6, 194, 230, 250, 292 CID

—CONTAINS—

Part #	Description
18-5488	Module
18-5404-1	Rotor

**18-5489
ELECTRONIC
DISTRIBUTOR**

Conventional Rotation
For Ford V8 351W CID



—CONTAINS—

Part #	Description
18-5376	Distributor Cap
18-5488	Module
18-5404-1	Rotor

**18-5494-1
ELECTRONIC
DISTRIBUTOR**

Conventional Rotation
For Chevrolet all V8 includes 482, 502, 540 CID (Except 348,409 & Tall Deck Big Block)



—CONTAINS—

Part #	Description
18-5376	Distributor Cap
18-5488	Module
18-5404-1	Rotor

**18-5495-1
ELECTRONIC
DISTRIBUTOR**

Conventional Rotation
For Ford V8 302 CID



—CONTAINS—

Part #	Description
18-5376	Distributor Cap
18-5488	Module
18-5404-1	Rotor

**18-5496-1
ELECTRONIC
DISTRIBUTOR**

Replaces: YLM567CV
Conventional Rotation
For Ford V8 351C — 460 CID



—CONTAINS—

Part #	Description
18-5376	Distributor Cap
18-5488	Module
18-5404-1	Rotor

**18-5497-1
ELECTRONIC
DISTRIBUTOR**

Replaces: YLM579AV
Conventional Rotation
For Chrysler V8 273,318 (67 & UP) 340, 360 CID "LA" engines



—CONTAINS—

Part #	Description
18-5376	Distributor Cap
18-5488	Module
18-5404-1	Rotor

**18-5498-1
ELECTRONIC
DISTRIBUTOR**

Replaces: YLM624BV
Reverse Rotation
For Chevrolet all V8 includes 482, 502, 540 CID (Except 348,409 & Tall Deck Big Block)



—CONTAINS—

Part #	Description
18-5376	Distributor Cap
18-5488	Module
18-5404-1	Rotor

**18-5309
DISTRIBUTOR**

Contact Controlled (Standard Rotation)
Replaces: Mallory YL512CV
For most Ford 302 CID V-8 Eng.
Uses: 18-5251 TUNE-UP KIT



—CONTAINS—

Part #	Description
18-5314	Contact Set
18-5338	Condenser
18-5404-1	Rotor

And 18-5376 CAP

**18-5312
DISTRIBUTOR**

Replaces: Mallory YL554CV
For most Ford 351 CID V-8 Eng.
Uses 18-5251 Tune-Up Kit
& 18-5376 Cap



**18-5313
DISTRIBUTOR**

Contact Controlled (Standard Rotation)
Replaces: 17177A1; Mallory YL624AV
For most GM V-8 Engs. (small & large blocks) Mallory Tall Cap
Uses: 18-5251 TUNE-UP KIT



—CONTAINS—

Part #	Description
18-5314	Contact Set
18-5338	Condenser
18-5404-1	Rotor

And 18-5376 CAP

**18-5315
DISTRIBUTOR**

Contact Controlled (Standard Rotation)
Replaces: 87581; Mallory YL673AV
For most GM 4 Cyl. Engs. (120 & 140 HP)
Uses: 18-5251 TUNE-UP KIT



—CONTAINS—

Part #	Description
18-5314	Contact Set
18-5338	Condenser
18-5404-1	Rotor

And 18-5397 CAP

PREMIUM MARINE SPARK PLUG WIRE LEADS

MAGFORCE™



OE Style boots provide a sealed barrier against heat, dirt and moisture.

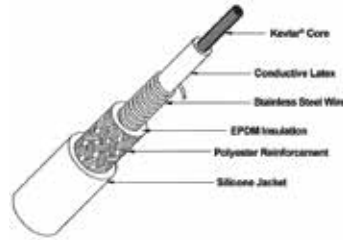

Premium Marine Wire Leads

Magnetic Suppression Core

Manufactured for your specific application

- Kevlar® core for maximum durability and long life.
- Durable stainless steel wound conductor for maximum horsepower and engine performance.
- Premium silicone jacketing and boots for the ultimate in high temperature protection.
- Superior RFI suppression for the most sensitive electronic system.
- Corrosion resistant stainless steel spark plug and distributor terminals for maximum conductivity.

O.E. #	Cyl.	Part #	O.E. #	Cyl.	Part #
84-816608Q81	8	18-8822-1	84-863656A2	V6	18-8829-1
84-847701A7	8	18-8837-1	84-813720A12, 84-816761Q12	8	18-8802-1
84-813720A2, 84-816608Q61	8	18-8804-1	84-813720A13, 84-816761Q13	4	18-8811-1
84-813720A3, 84-816761Q3	8	18-8804-1	84-816761A4, 84-816761Q4	8	18-8804-1
84-813720A3, 84-816761Q3	8	18-8821-1	84-816761A4, 84-816761Q4	8	18-8821-1
84-813720A4, 84-816761Q4	8	18-8821-1	84-816761A8, 84-816761Q8	L6	18-8809-1
84-813720A4, 84-816761Q4	8	18-8804-1	84-816761A9, 84-816761Q9	8	18-8803-2
84-813720A5, 84-816761Q5	4	18-8800-1	84-816761A17, 84-816761Q17	8	18-8821-1
84-813720A6, 84-816761Q6	4	18-8808-2	84-863656A1	8	18-8828-1
84-816761K14	L4	18-8833-1	84-816608Q80	8	18-8830-1
84-813720A7, 84-816761Q7	V6	18-8801-1	84-816608Q71	8	18-8836-1
84-813720A8, 84-816761Q8	L6	18-8809-1	84-816608K68	8	18-8832-1
84-813720A9, 84-816761Q9	8	18-8803-2	84-816608Q83	8	18-8834-1
84-813720A10, 84-816761Q10	8	18-8803-2	84-881698	8	18-8838-1
84-813720A11, 84-816761Q16	V6	18-8810-1	84-816608K68	8	18-8824-1
84-816608Q82	V6	18-8835-1			

Models	Cyl.	Ignition Type	Part #	Models	Cyl.	Ignition Type	Part #
ALL	4	Digital	18-8811-1	370	8	Conventional	18-8803-2
120 (153 CID)	4	Conventional	18-8800-1	400	8	Conventional	18-8803-2
140 (181 CID)	4	Conventional	18-8800-1	420	8	Thunderbolt	18-8804-1
150	L6	Conventional	18-8809-1	420	8	Thunderbolt	18-8837-1
160	L6	Conventional	18-8809-1	425	8	Thunderbolt	18-8837-1
165	L6	Conventional	18-8809-1	440	8	Conventional	18-8803-2
185 CID	V6	Conventional	18-8801-1	454 CID	8	Thunderbolt	18-8804-1
198 GM	8	Conventional	18-8803-2	454 MAG	8	Thunderbolt	18-8804-1
224 CID	4	Conventional	18-8808-2	454 EFI, Mag MPI and Horizin MIE	8	Delco HEI	18-8832-1
225 FORD	8	Conventional	18-8803-2	454 Hi Perf	8	Thunderbolt	18-8824-1
225 GM	8	Conventional	18-8803-2	460	8	Conventional	18-8803-2
228 GM	8	Conventional	18-8803-2	465	8	Thunderbolt	18-8837-1
229 CID	V6	Conventional	18-8801-1	496	8	Distributorless	18-8838-1
233 FORD	8	Conventional	18-8803-2	500	8	Thunderbolt	18-8837-1
250 GM	8	Conventional	18-8803-2	500 Bulldog	8	Thunderbolt	18-8837-1
255 FORD	8	Conventional	18-8803-2	502 Mag	8	Delco HEI	18-8832-1
260 GM	8	Conventional	18-8803-2	502 EFI & Mag MPI	8	Delco HEI	18-8832-1
260 TR	8	Thunderbolt	18-8804-1	525SC	8	Thunderbolt	18-8837-1
262 CID	V6	Thunderbolt	18-8810-1	600SC	8	Thunderbolt	18-8837-1
280 GM	8	Conventional	18-8803-2	800SC	8	Thunderbolt	18-8837-1
305 CID LH	8	Thunderbolt	18-8804-1	888 FORD	8	Conventional	18-8803-2
305 CID RH	8	Thunderbolt	18-8804-1	898 GM	8	Conventional	18-8803-2
320 EFI	8	Thunderbolt	18-8804-1	2.5L	4	Conventional	18-8800-1
330	8	Conventional	18-8803-2	3.0L	4	Conventional	18-8800-1
330 TR	8	Thunderbolt	18-8804-1	3.0LX	4	Delco EST	18-8833-1
350 CID LH	8	Thunderbolt	18-8804-1	3.7L	4	Conventional	18-8808-2
350 CID RH	8	Thunderbolt	18-8804-1	3.7XL	4	Conventional	18-8808-2
350 MAG	8	Thunderbolt	18-8804-1	4.3L	V6	Thunderbolt	18-8810-1
350 MAG SKI	8	Thunderbolt	18-8821-1	4.3XL	V6	Thunderbolt	18-8810-1
350 MAG BRAVO MPI & GEN +	8	Delco HEI	18-8836-1	4.3L EFI(TBI)	V6	Thunderbolt	18-8810-1
350 MAG MPI MIE (GEN +)	8	Delco HEI	18-8832-1	4.3L MPI	V6	Delco HEI	18-8835-1
350 MAG MPI MIE (GEN +)	8	Mercury HEI	18-8834-1	5.0L	8	Thunderbolt	18-8804-1
350 MAG EFI SKI	8	Delco HEI	18-8832-1	5.0L IB	8	Thunderbolt	18-8804-1
350 MAG MPI SKI (GEN +)	8	Delco HEI	18-8836-1	5.0LX	8	Thunderbolt	18-8804-1
BLACK SCORPION SKI (GEN+) 350CID	8	Delco HEI	18-8832-1	5.0L Alpha & Bravo (Gen+)	8	Thunderbolt	18-8821-1
BLACK SCORPION SKI (GEN+) 350CID	8	Delco HEI	18-8822-1	5.0L MIE MPI	8	Delco HEI	18-8828-1
MX 6.2 BLACK SCORPION SKI	8	Delco HEI	18-8822-1	5.7L	8	Thunderbolt	18-8804-1
				5.7L IB	8	Thunderbolt	18-8804-1
				5.7L SKI	8	Conventional	18-8802-1
				7.4L	8	Thunderbolt	18-8804-1
				7.4L IB	8	Thunderbolt	18-8804-1

I/O — MERCURUISER - Ignition System



**18-5225
SPARK PLUG WIRE KIT**

Replaces:
Mercury 84-99215A26,
84-813706A26
Kit includes 25 ft. roll of 7 MM hypalon ignition wire with a metallic core and a large assortment of three different end fittings.



BATTERY CABLES

Part No.	Size	Color	Gauge	Part No.	Size	Color	Gauge
BC88523	2'	red	4	BC88573	6'	black	2
BC88533	2'	black	4	BC88583	8'	red	1
BC88543	4'	red	2	BC88593	8'	black	1
BC88553	4'	black	2				

BC88563 gauge cable with soldered lug terminals on each end to accept a 3/8" stud



**18-5226
IGNITION WIRE**
Metallic Core
100' Spool
7mm Hypalon

PKG. OF 10



**18-5224
18-5224-9①
SPARK PLUG WIRE
TERMINAL**
Replaces: Mercury 20121

PKG. OF 10



**18-5750
18-5750-9①
UNIVERSAL SPARK
PLUG BOOTS**
Supplied complete w/Terminal Connector



**18-5752
UNIVERSAL
SPARK PLUG BOOT**
8mm

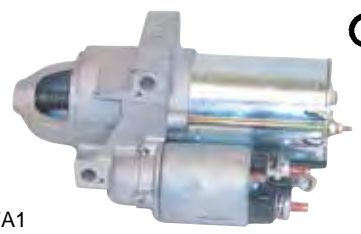
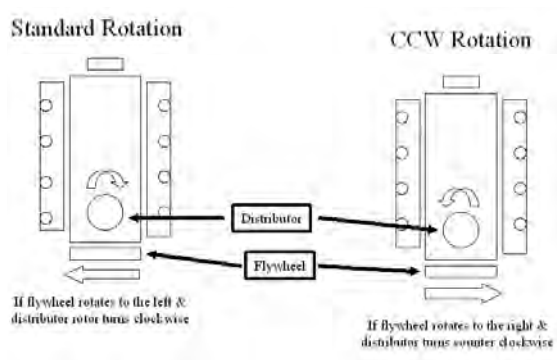

**18-6275
STARTER**
Replaces:
50-807904A1, 50-863007A1
• Permanent Magnet Gear Reduction Starter
• Inboard
• 2 Long Bolt Offset Pattern
• CW Rotation • **SAE J1171**
• Use w/ Late Model 3.0L Engines with 14" Flywheel
Fits : Volvo Penta, Mercruiser, Marine Power



**18-5603
STARTER**
Replaces: 50-808011A4
Noseless:CCW Top mount rear entry starter for standard rotation GM & Ford engines. Can be used in place of 18-5908 and 18-5902



**18-5923
STARTER**
PMGR Replacement for 18-5903;
302CID, 351CID Ford Engines



**18-5911
STARTER**
(Heavy-Duty) (No Core) (Clockwise) For GM engines, bottom mount straight across bolt pattern. Standard rotation
Replaces: 50-76965A4,50-99417A2,50-99419A3, 50-17251A3, 50-77328A3
Replacement Solenoid: 18-5837
SAEJ1171



**18-5900
REMANUFACTURED STARTER**



**18-5907
STARTER**
(Heavy-Duty) (No Core) (Clockwise) Top mount rear entry starter for opposite rotation GM & Ford engines.
Will also replace standard rotation. Will not replace non-starter mounted solenoids.
Mercuriser built 4 cyl. 165/170/180/190/470/485/488
Replaces: 50-72550A2, 50-79604A3, 50-97499A2, R4, 50-72550R2, 50-97499R3
Replacement Solenoid: 18-5837
SAEJ1171



**18-5901
REMANUFACTURED STARTER**



**18-5913
STARTER**
(Clockwise)
Delco permanent magnet gear reduction 2 bolt starter
12V - 11 Tooth - Offset Bolt Pattern
For: Late model GM - 14" Flywheel
Replaces: 50-812428A3, 50-812604A2,
50-822330A2, 50-864340A2
Replacement Solenoid: 18-6287
SAEJ1171 FOR: 4.3L (1996 & UP); 5.0 & 5.7L (1998 & UP)



**18-5919
STARTER**
Permanent magnet I/O starter, 11 Tooth
Replaces: 50-806963A4, 50-806965A2, 50-806965A4
Replacement Solenoid: 18-6287
Fits: Chevy Engines with 12 3/4" flywheels
Straight across bolt pattern
SN-OF803000AN/OF803114AN 4.3LX/LXH Alpha/Bravo 262 CID
SN-355305AN/22560AN 5.7L Alpha (EFI)/5.7L Bravo (EFI)
SAEJ1171



**18-5910
STARTER**
(Heavy-Duty) (No Core) (Clockwise) Small block V-6 & V-8 GM engine with 14 1/4" flywheel and bottom mount, offset bolt pattern. For standard rotation engines.
Replaces: 50-12177A2, 50-99418A2



**18-5905
REMANUFACTURED STARTER**



**18-5908
STARTER**

**18-5902
REMANUFACTURED STARTER**
(Heavy-Duty) (No Core) (Counter-Clockwise)
Top mount rear entry starter for standard rotation GM & Ford engines.
Replaces: 50-76965A3, 50-808011A1
Replacement Solenoid: 18-5837
SAEJ1171



**18-5902
REMANUFACTURED STARTER**



NEW



**18-6824
STARTER**
Replaces: 50-60594A, A1, T01
Fits: 2.0, 2.4, and 2.5L Racing Engines

NEW



**18-6834
STARTER**
Replaces: GM Engines Universal
Used on Buick, Chevrolet, Oldsmobile, and Pontiac Race Engines

NEW



**18-6835
STARTER**
Replaces: GM Engines Universal
Used on Buick, Chevrolet, Oldsmobile, and Pontiac Race Engines

NEW



**18-6870
STARTER**
Replaces: Mercury 50-805833, T
Fits: D7.3L D-tronic 260 LD, 300 1999 year

NEW



**18-6946
STARTER**
Replaces: 50-8m8021116

NEW



**18-6947
STARTER**
Replaces: Mercruiser 50-805991
Fits: 7.3L (BRAVO & MIE) DIESEL NAV 444 V-8 1994-1996

NEW



**18-6949
STARTER**
Replaces: Mercruiser 50-831001562, 50-831001961
Fits: WO4CTA (150 HP) HINO 234 I/L4, WO4CTI (210 HP) HINO 234 I/L4

NEW



**18-6957
STARTER**
Replaces: Mercruiser 50-801333980, 50-854178, 50-855507



**18-5903
STARTER
(No Core) (Clockwise) Bottom mount, two bolt
pattern for standard rotation Ford engines.**
Replaces: 50-69865A1, 50-12872, 50-56886
Replacement Solenoid: 18-5801
*For PMGR style order 18-5923



**18-2434
FLYWHEEL BELL HOUSING**
Replaces: 814309A1
For: GM V-8's Big & Small Blocks Inboard/Ski Models

STARTER BOLTS



Description	Mercuriser #	Part #
Starter Bolt 3/8 - 16 - 4 3/8 Long	10-8053432	18-8402
Starter Bolt 3/8 - 16 - 1 13/16 Long	10-8053433	18-8403
Starter Bolt 3/8 - 16 - 1 11/16 Long	10-8083434	18-8404-1



**18-5717
STARTER
BRUSH SET**
Replaces: 33270



**18-5804
SOLENOID**
Replaces: 13037
Delco



**18-5837
SOLENOID**
Replaces: 89-99253, 89-18080
Delco



**18-5838
SOLENOID**
Replaces: 33261, 89902
Delco



**18-5840
SOLENOID**
Prestolite 15-79,
SAW 4201, SAW4207, SAW4210

BRUSH SET/STARTER SWITCH APPLICATION

Years	Volt.	Starter No.	Brush Set	Starter Switch	Years	Volt.	Starter No.	Brush Set	Starter Switch
1977-82	12	1108755	18-5717	18-5838	1971-78	12	ALL	18-5717	18-5838
1977-82	12	1108756	18-5717	—	1969-78	12	MEO-7003	—	18-5840
1977-82	12	1109484,5,6	18-5717	18-5838					



**18-5801
SOLENOID**
Replaces: 89-76416A1

① **18-5801D** Display Package

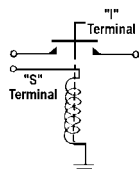

**18-5802
SOLENOID**
Replaces: 65057A1, 65057T1

① **18-5802D** Display Package

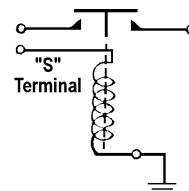

① Items ending in "D" are Display Packaged - Regular number is Non-Display
APPLICATION BEGINS ON PAGE 605

① 18-5810D 



**18-5810
SOLENOID**



**18-5811
STARTER SOLENOID**
Replaces: 809463A1
For: PG 260 Series Starters, GM V6 & V8 (1983-Up)

① 18-5815D 



**18-5815
SOLENOID**
Replaces: 89-68258A4,
89-853654A1, 89-76545

① 18-5816D 

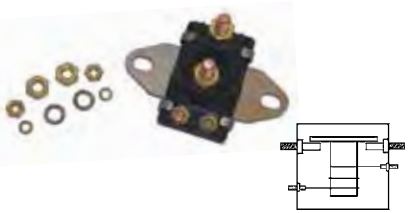

**18-5816
SOLENOID**
Replaces: 89-96054, T, 89-91975
(Flat Bracket)

① 18-5817D 

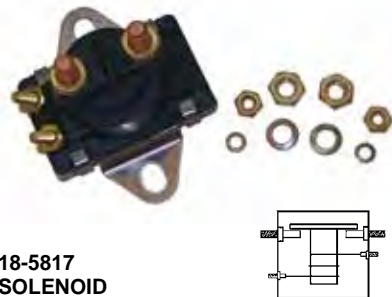

**18-5817
SOLENOID**
Replaces: 89-96158, T
(Curved Bracket)



**18-5820
SOLENOID**
Replaces: 89-818999A2,
89-825842A1, 89-850188T1

① 18-5836D 



**18-5836
SOLENOID**
Replaces: 25661, 25661 1



**18-9802
TIMING LIGHT**
Self-powered accurate up to 10,000 RPM's



**18-6749
TRIM BRACKET**
Metal Bracket
Replaces: 862548A1, 42419A1
For: MerCruiser Floor Mount Bracket



**18-6750
TRIM BRACKET**
Stainless Steel
Replaces: 862548A1, 42419A1
For: MerCruiser Floor Mount Bracket



**18-6752
HYDRAULIC TRIM
PUMP ASSEMBLY**
Metal Bracket
Replaces: 14336A9, 88183A12
Fits: 1983 and Later without "quick connect"



**18-6753
HYDRAULIC TRIM
PUMP ASSEMBLY**
Stainless Steel Bracket
Replaces: 14336A9, 88183A12
Fits: 1983 and Later without "quick connect"

① Items ending in "D" are Display Packaged - Regular number is Non-Display



18-6768
COMPLETE POWER TRIM PUMP ASSEMBLY
Steel Bracket
 Replaces: 93247A7
 Replacement pump for Prestolite high pressure/low flow system. Primarily used 1982 and earlier.



18-6799
COMPLETE POWER TRIM PUMP ASSEMBLY
Stainless Steel Bracket
 Mercruiser 93247A7
 Replacement pump for Prestolite high pressure/low flow system. Salt water series. Stainless steel bracket. Primarily used 1982 and earlier.

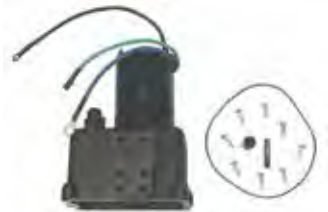

18-6763
TILT/TRIM MOTOR
 Replaces: 92975A6, 79271A4, 67914A2, 92975A32, 93247A7
 To 1984. Fits most Mercruiser Sterndrives (Motor and Reservoir Only)
 For Repair Kit use: **18-6253**



18-6769-1
TILT/TRIM PUMP
Low Pressure - High Flow
 Replaces: 14336A8, 88183A5 From 1984
 Fits most Mercruiser Sterndrives



18-6772
TILT PUMP MOTOR
 Replaces: 17649, 17649T, 891736T
 For late style Alpha I, Generation II, and Bravo drives; early style square motors.
 Mercruiser Sterndrive replacement for Oildyne units



18-6274
TILT/TRIM MOTOR
 Replaces: 14336A20
 Oildyne low pressure/high flow



18-6813
TRIM MOTOR
 Replaces: 14336A6, A8, A9, A15, A20, 88183A5, A8, A12, 865380A13, A25



18-6771
TILT/TRIM RESERVOIR
 Replaces: 18525A1



18-6778
TILT/TRIM RESERVOIR
 Replaces: 883166A2
 For: Tilt Motors with 4 Screw Attachments



18-6823
WIRING HARNESS
 Replaces: Universal
 Converts 3-wire Tilt and Trim motors to 2-Wire design



18-5872
STATOR
 Replaces: 398-6231A10
 For: 3.7L 1983-89



18-6254
COMMUTATOR END PLATE
 Replaces: 392-2940
 For : Use with Prestolite Pumps (Mercury #'s 79271A4 and 88475A5)



18-6253
COMMUTATOR END PLATE
 For use with **18-6763**



18-6256
POWER TRIM SPRING SET
 Replaces: 392-2529
 For : Use with Prestolite Pumps (Mercury #'s 74436A9, 79271A4, 88475A5 and 93247A4)



18-6255
POWER TRIM BRUSH
 Replaces: 392-8989
 For : Use with Prestolite Pumps (Mercury #'s 93247A4)



18-6293
ALTERNATOR
 Replaces: 862031T • SAE J1171
 7SI/70 amp, Hinge Mount,
 Serpentine Pulley 2.44" Diameter



18-6298
ALTERNATOR
 Replaces: 863077T • SAE J1171
 7SI/70 amp, Hinge Mount,
 Serpentine Pulley 1.97" Diameter



18-5983
ALTERNATOR
 Replaces: 862030T • SAE J1171
 7SI/70 amp, Hinge Mount, Single Groove Pulley



18-5956
ALTERNATOR
 (1-Wire) (No Core) (68 AMP)
 Single wire connection fits Mercruiser and many other
 applications. Equipped with fan and drive pulley.
 Replaces: 69729 • SAE J1171



18-5950
ALTERNATOR
 (1-Wire) (No Core) (68 AMP)
 Single wire connection fits Mercruiser and many other ap-
 plications. Equipped with fan and drive pulley.
 Replaces: 69729 • SAE J1171
 (Remanufactured)



18-5957
ALTERNATOR
 (3-Wire) (No Core) (68 AMP)
 Replaces Mando, Motorola and original equipment
 Delco. Uses same electrical connections and
 mounting method. Equipped with fan and drive pulley.
 Replaces: 78477, 78403A2, 92497A3.
 • SAE J1171



18-5951
ALTERNATOR
 (3-Wire) (No Core) (68 AMP)
 Replaces Mando, Motorola and original equipment
 Delco. Uses same electrical connections and
 mounting method. Equipped with fan and drive pulley.
 Replaces: 78477, 78403A2, 92497A3
 (Remanufactured) • SAE J1171



18-5946
ALTERNATOR
 (1-Wire) (No Core) (68 AMP)
 Single wire connection fits Mercruiser and many
 other applications. Equipped with fan and
 serpentine drive pulley. • SAE J1171



18-5945
ALTERNATOR
 (3-Wire) (No Core) (68 AMP) • SAE J1171
 Replaces Mando, Motorola and original equipment
 Delco. Uses same electrical connections and mounting
 method. Equipped with fan and serpentine drive pulley.



18-5960
ALTERNATOR
 Serpentine Pulley • 65 Amp
 Replaces: 807653T • SAE J1171



18-5966
ALTERNATOR
 Single Groove Pulley • 55 Amp
 Replaces: 817119A4, 12449A1 • SAE J1171



18-5967
ALTERNATOR
 Serpentine Pulley • 55 Amp
 Replaces: 807652T • SAE J1171



18-5965
ALTERNATOR
 65 Amp
 Replaces: 817119A1,
 817119A4, 805884T
 SAE J1171



18-6841
ALTERNATOR
 Replaces: Mercruiser 56045,
 59755, 69729
 For: 37-63A Marine Applications



18-6842
ALTERNATOR
 Replaces: Mercruiser 56045,
 59755, 69729
 For: 37-63A Marine Applications



18-6844
ALTERNATOR
 Replaces: Mercruiser 834832,
 T2, 857006A3,
 Denso 101211-3460





NEW

**18-6948
ALTERNATOR**
Replaces: Mercury 882571
Fits: CMD 1.7 MI 120 I/L4, CMD 1.7 MS 120 I/L4, D1.7L DTI



NEW

**18-6960
ALTERNATOR**
Replaces: Mercruiser 821663, -1, A1, Denso 101211-3020, 3021



**18-5953-1
ALTERNATOR CONVERSION KIT**
Includes new 68 AMP alternator, mounting brackets 18-5968, pulley, wiring, hardware and instructions. Converts model 470 aluminum block Mercruiser engines serial number 4625580 & up with stator charging system and water cooled voltage regulator to alternator system. **NOTE: Fuse kit 18-8220 (sold separately) is required on engines with a Delco starter (round solenoid mounted to starter); Prestolite starters with remote solenoid DO NOT require fuse kit. Visually inspect starter prior to ordering conversion kit**

CE
MARINE
UL
LISTED



**18-5949
CONVERSION KIT DRIVE BELT**
Replacement belt for alternator conversion kit used on 470 Series Mercruisers. Included in 18-5953-1 kit.



**18-5968
ALTERNATOR BRACKET**
Replacement bracket for alternator conversion kit used on 470 Series Mercruiser included in 18-5953 kit



**18-8220
FUSE KIT**
Replace: 88-79023A91
For use with 18-5953 alternator conversion kits installed on Mercruiser (Model 470) 3.7 liter aluminum block engines serial number 6902288 & Up.
90 AMP



**18-5740
VOLTAGE REGULATOR**
Replaces: 42785

Model #	Cyl.	Years	Beg. S/N	End. S/N	Slave Solenoid	Reman Starter	New Starter	Reman Alternator	New Alternator
110	GM 4	1963-1966	1538370	2044033	18-5836	18-5900	18-5911	—	—
120	GM 4	1964-1975	1666601	4469865	18-5836	18-5900	18-5911	18-5951	18-5957
120	GM 4	1976-1982	4469866	6229717	18-5815	18-5900	18-5911	18-5951	18-5957
120 / 2.5L	GM 4	1983-1989	6229718	C853255	18-5817	18-5900	18-5911	—	18-5966 ④
140	GM 4	1968-1975	2508261	4460664	18-5836	18-5900	18-5911	18-5951	18-5957
140	GM 4	1976-1981	4460665	6229717	18-5815	18-5900	18-5911	18-5951	18-5957
140/3.0L	GM 4	1982-1989	6229718	C856558	18-5817	18-5900	18-5911	18-5951	18-5957
140/3.0L	GM 4	1999-2001	OL382122	OM326292	18-5817	—	18-6275	—	18-5983 **
140/3.0L/3.0LX	GM 4	1990-92	C856559	D831100	18-5817	18-5900	18-5911	18-5951	18-5957
140/3.0LX	GM 4	1992-97	D831101	OK999999	18-5817	N/A	18-6275	—	18-5966 ④
165/3.7L	Merc 4	1987-1989	B434941	C762299	18-5802	18-5901	18-5907	N/A	N/A
170	Merc 4	1985-1986	6916779	B434940	18-5802	18-5901	18-5907	N/A	N/A
180/3.7LX	Merc 4	1987-1989	B436391	C762299	18-5802	18-5901	18-5907	N/A	N/A
190	Merc 4	1985-1986	6916779	B436390	18-5802	18-5901	18-5907	N/A	N/A
470	Merc 4	1976-1984	4208730	6916778	18-5802	18-5901	18-5907	N/A	N/A
470MIE	Merc 4	1980-1981	5520115	6218036	18-5802	18-5901	18-5907	N/A	N/A
485	Merc 4	1980-1984	5685394	6916778	18-5802	18-5901	18-5907	N/A	N/A
140	GM 6	1963	1538930	1725960	18-5836	18-5900	18-5911	—	—
150	GM 6	1964-66	1666495	2048046	18-5836	18-5900	18-5911	—	—
160	GM 6	1967-69	2048022	2768031	18-5836	18-5900	18-5911	—	—
160	GM 6	1969	2768032	2770031	18-5836	18-5900	18-5911	18-5951	18-5957
165	GM 6	1970-1975	2770032	4471565	18-5836	18-5900	18-5911	18-5951	18-5957
165	GM 6	1976-1981	4471566	5813433	18-5815	18-5900	18-5911	18-5951	18-5957
200	GM 6	1969	2453769	2712072	18-5836	18-5900	18-5911	—	—
175/4.3L	GM V-6	1987-1992	B527955	D714106	18-5816	—	18-5913	—	18-5966 ④
185	GM V-6	1983-1984	6330183	6919655	18-5816	18-5900	18-5911	—	18-5966 ④
185	GM V-6	1985-1987	A331455	B527954	18-5816	N/A	18-5913	—	18-5966 ④
205	GM V-6	1985-1991	A331455	D714369	18-5816	N/A	18-5913	—	18-5966 ④
262 Mag. EFI	GM V-6	1996-1997	F803800	K999999	18-5817	N/A	18-5913	—	18-5960
262 Mag. EFI	GM V-6	1996-1997	F803800	K999999	18-5817	N/A	18-5913	—	18-5960
4.3L/LX/LXH	GM V-6	1992-1997	D714107	K999999	18-5817	—	18-5913	—	18-5967
4.3L/LX/LXH	GM V-6	1996-1997	F803000	K999999	18-5817	—	18-5913	—	18-5967
4.3L/LH	GM V-6	1998-99	L010044	OL618999	18-5817	—	18-5913	—	18-5967
4.3L/LH(Gen +)	GM V-6	2000-02	OL619000	OM320024	18-5817	—	18-5913	—	18-6293 **
4.3EFI	GM V-6	1998-99	L012009	OL618999	18-5817	—	18-5913	—	18-5960
4.3L EFI	GM V-6	2000-01	OL619000	OM299999	18-5817	—	18-5913	—	18-6293 **
4.3L MPI	GM V-6	2002	OM300000	OM320024	18-5817	—	18-5913	—	18-6293 **
190	GM V-8	1963-1964	1564539	1730903	18-5836	18-5900	18-5911	—	—
200	GM V-8	1985-1986	6218462	B525981	18-5816	18-5900	18-5911 ① ③	—	18-5966 ④
200	GM V-8	1985-1986	6218462	B525981	18-5816	18-5905	18-5910 ② ⑥	—	18-5966 ④
200/5.0L	GM V-8	1987-1995	B525982	F600999	18-5816	18-5905	18-5910	—	18-5966 ④
200/5.0L	GM V-8	1987-1995	B525982	F600999	18-5817	18-5905	18-5910	—	18-5966 ④
215 MCM & MIE	Ford V-8	1970-1972	2781153	3563181	18-5836	18-5902	18-5908 ①	18-5951	18-5957

① For 12 3/4" Dia. Flywheel
 ② For 14" Dia. Flywheel
 ③ For permanent magnet models use 18-5919
 ④ 55 AMP up grade to 65 AMP use 18-5965
 ⑤ Black
 ⑥ For permanent magnet models use 18-5913
 ⑦ Bravo drive
 ⑧ Firepower ignition
 ⑨ Ignition module mounted on distributor
 ⑩ Ignition module mounted on elbow
 ⑪ LH rotation
 ⑫ NLA for models prior to S/N 4167000
 ⑬ PG 260 (9-1/4" long)
 ⑭ PG260F1 (8-1/2" long)
 ⑮ RH Rotation
 ⑯ Standard ignition
 ⑰ Thunderbolt ignition
 ⑱ Thunderbolt IV
 ⑲ Thunderbolt V
 ⑳ Transmission models
 ** Delco Style



**18-7683
FUEL PRESSURE REGULATOR**
Replaces: 849899
Fits: MCM 500 EFI



**18-7662
FUEL PRESSURE
REGULATOR**
Replaces: 885174
4.3L, 5.0L, 5.7L & 6.2L MPI engines with
555 ECM-regulator mounted on fuel rail



**18-7663
FUEL PRESSURE
REGULATOR**
Replaces: 802630T01
7.4L MPI (L29)



**18-7652
FUEL PRESSURE
REGULATOR**
Replaces: 805227A1



**18-7600
TEMPERATURE SENSOR**
Replaces: 805218T



**18-7700
THROTTLE
POSITION SENSOR**
Replaces: 853678T
Fits: MCM/MIE 4.3L MPI, 5.0L MPI,
MX6.2L MPI w/ECM 555 and 350 Mag
MPI, Black Scorpion Tow Sports, 377
Scorpion Tow Sports, 7.4L MPI(L29) &
MCM 496 Mag & HO and MIE 8.1S & HO



**18-7630
THROTTLE POSITION
SENSOR**
Replaces: 805226A1



**18-7701
IDLE SPEED
CONTROL MOTOR**
Replaces: 862998
Fits: MCM 3.0L MPI, V6 & V8(305, 350
& 496 cid)MPI engines w/ECM555



**18-7697
IAC MOTOR**
Replaces: 803149
Fits: MCM/MIE 350 Mag MPI, Black
Scorpion Tow Sports, 377 Scorpion
MCM & Tow Sports, MX6.2L MPI, 7.4L
MPI(L29) & 575 Sci



**18-7632
IDLE AIR CONTROL MOTOR**
Replaces: 805224A1



**18-7682
MAP SENSOR**
Replaces: 849934
Fits: MCM 575 Sci



**18-7684
MAP SENSOR**
Replaces: 864856A1
Fits: MCM/MIE GM V6 & V8 (350, 377,
454 & 502cid)EFI Engines



**18-7660
MAP SENSOR**
Replaces: 881731
V-6 & V-8 MPI engines with 555 ECM



**18-7668
MAP SENSOR**
Replaces: 854445
525 EFI



**18-7677
KNOCK SENSOR**
Replaces: 806612T
Fits: GM V8(305, 350 & 377 cid) engines



**18-7703
KNOCK SENSOR**
Replaces: 805544T



**18-7646
CAMSHAFT SENSOR**
Replaces: 892615002



**18-7685
TBI INJECTOR**
Replaces: 852956A1
Fits: MCM GM V6 & V8 (305 & 350 cid)
TBI engines



**18-7686
FUEL INJECTOR**
Replaces: 849896
Fits: MCM 500 EFI



18-7688
FUEL INJECTOR
 Replaces: 885176
 Fits: MCM 4.3L MPI engines (s/n OM300000-1A063239) & 5.0L, 5.7L & 6.2L MPI engines w/ ECM 555 (s/n OM300000-1A064824)



18-7698
FUEL INJECTOR
 Replaces: 881693002
 Fits: MCM 496 Mag & HO and MIE 8.1S & HO

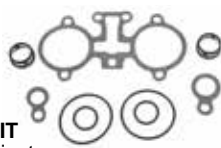

18-7690
INJECTOR SEAL KIT
 Use with Mercury Injector # 852956A1, 853998A1
 Fits: 262 Mag EFI (1996-97), 4.3L EFI (1998-01), 5.0L EFI (1998-01), 350 Mag Alpha EFI (Gen+) (1996-97), 350 Mag EFI SKI (1994-97), 5.7L EFI (1995-01), 5.7L EFI MIE (Gen+) (1997), 5.7L LX Bravo EFI (Gen+) (1996-97), 5.7L LX EFI (1995-97), 7.4L LX TBI (1996-97), 575 Sci (2000-05)



18-7691
INJECTOR SEAL KIT
 Use with Mercury Injector # 806807A1
 Fits: 350 Mag Bravo MPI (1995-96), Black Scorpion SKI (1996)



18-7692
INJECTOR SEAL KIT
 Use with Mercury Injector # 861260T
 Fits: 350 Mag MPI(98-01), 350 Mag MPI Horizon MIE(99-01), 350 Mag MPI MIE(98-01), 350 Mag MPI SKI(98-01), MX 6.2L MPI(00-01), 454 Mag MPI(99-01), 454 Mag MPI Horizon MIE(99-01), 502 Mag MPI(99-01), 8.2L MPI(99-01)



18-7693
INJECTOR SEAL KIT
 Use with Mercury Injector # 802632T, 849896
 Fits: 7.4L MPI(L29)(98-01), 7.4L MPI MIE(L29)(98-01), 500 EFI(99-05)



18-7694
INJECTOR SEAL KIT
 Use with Mercury Injector # 881693002
 Fits: 496 Mag (2001-08), 496 Mag DTS (2001-08), 496 Mag HO (2001-08), 496 Mag HO DTS (2001-08), 8.1L MIE (2001-08), 496 Mag DTS (2001-08), 8.1L HO MIE (2001-08), 496 Mag HO DTS (2001-08)



18-7695
INJECTOR SEAL KIT
 Use with Mercury Injector # 885176
 Fits: 4.3L MPI(02-08), 5.0L MPI(02-08), 5.0L MPI DTS(05-08), 350 Mag MPI(02-08), 350 Mag MPI DTS(05-08), 350 Mag MPI Horizon(02-07), 350 Mag MPI MIE(02-07), 350 Mag MPI MIE DTS(05-07), 350 Mag MPI SKI(02-07), 350 Mag MPI SKI DTS(05-07), 350 Mag MPI SKI MIE(08), 5.7L MPI SKI(08), MX6.2L MPI(02-07), MX6.2L MPI DTS(05-07), MX6.2L MPI Horizon(04-07), MX6.2L MPI Horizon DTS(05-07), MX6.2L MPI Horizon MIE(02-08), MX6.2L MPI Horizon MIE DTS(05-08), MX 6.2L MPI MIE(02-07), MX6.2L MPI MIE DTS(05-07), MX6.2L MPI SKI(02-07)



18-7696
INJECTOR SEAL KIT
 Use with Mercury Injector # 805225A1
 Fits: 320 EFI(87-89), 350 Mag Bravo MPI(Gen+)(97), Black Scorpion SKI(97-08), 377 Scorpion MCM(99-05), 377 Scorpion SKI(97-98), MX6.2L Black Scorpion SKI (01-07), 454 Mag EFI SKI(94-97), 454 Mag MPI(96-98), 454 Mag MPI Horizon MIE(98), 7.4L MPI MIE(95-97), 7.4LX MPI(96-97), 502 Mag MPI(93-98), 525 EFI(03-08), 8.2L MPI MIE(96-98)

FUEL INJECTION SYSTEM APPLICATION

Model	Liter	CID	# Cyl	Year Range	Serial # Range	Injector	IAC Valve	TPS	F/P Regulator Rail-Mounted	F/P Regular Cooler Mounted	MAP Sensor
3.0L MPI	3.0L	181	L4	2008-2010	A072812 & UP	N/A	18-7701	N/A	N/A	N/A	N/A
262 MAG EFI	4.3L	262	V-6	1996-1997	F803800 - K999999	18-7685	18-7632	18-7630	N/A	N/A	18-7684
4.3L EFI	4.3L	262	V-6	1998-2001	L012009 - M299999	18-7685	18-7632	18-7630	N/A	N/A	N/A
4.3L MPI	4.3L	262	V-6	2002-2007	M300000 - A063239	18-7688	18-7701	18-7700	18-7662	N/A	N/A ②
4.3L MPI	4.3L	262	V-6	2007-2010	A063240 & UP	N/A	18-7701	18-7700	18-7662	N/A	N/A ②
5.0L EFI	5.0L	305	V-8	1998-2001	L012052 - M299999	18-7685	18-7632	18-7630	N/A	N/A	N/A
5.0L MPI	5.0L	305	V-6	2002-2007	M300000 - A064824	18-7688	18-7701	18-7700	18-7662	N/A	N/A ②
5.0L MPI	5.0L	305	V-6	2007-2010	A064825 & UP	N/A	18-7701	18-7700	18-7662	N/A	N/A ②
5.0L MPI DTS	5.0L	305	V-8	2005-2007	W310000 - A064824	18-7685	N/A	N/A	18-7662	N/A	N/A
5.0L MPI DTS	5.0L	305	V-8	2010	A064825 & UP	N/A	N/A	N/A	18-7662	N/A	N/A
350 MAG ALPHA EFI (GEN +)	5.7L	350	V-8	1996-1997	F800300 - K999999	18-7685	18-7632	18-7630	N/A	N/A	18-7684
350 MAG BRAVO MPI	5.7L	350	V-8	1995-1996	F415189 - K001500	N/A	18-7632	18-7630	N.L.A.	N/A	18-7684 ②
350 MAG BRAVO MPI (GEN +)	5.7L	350	V-8	1997	K001501 - K999999	N/A	18-7632	18-7630	N/A	N/A	18-7684 ②
350 MAG EFI SKI	5.7L	350	V-8	1994-1996	F215561 - F820706	18-7685	18-7632	18-7630	N/A	N/A	18-7684
350 MAG EFI SKI	5.7L	350	V-8	1996	F820707 - K040005	18-7685	18-7632	18-7630	N/A	N/A	18-7684
350 MAG MPI	5.7L	350	V-8	1998	L010019 - L331598	N/A	18-7697	18-7700	N/A	N/A	N/A
350 MAG MPI	5.7L	350	V-8	1998	L336000 - L346999	N/A	18-7697	18-7700	N/A	N/A	N/A
350 MAG MPI	5.7L	350	V-8	1999	L331599 - L335999	N/A	18-7697	18-7757	N/A	N/A	N/A
350 MAG MPI	5.7L	350	V-8	1999-2001	L340000 - M299999	N/A	18-7697	18-7757	N/A	N/A	N/A
350 MAG MPI	5.7L	350	V-8	2002-2007	M300000 - A064824	18-7688	18-7701	18-7700	18-7662	N/A	N/A ②
350 MAG MPI DTS	5.7L	350	V-8	2005-2007	W310000 - A064824	18-7688	N/A	N/A	18-7662	N/A	N/A ②
350 MAG MPI DTS	5.7L	350	V-8	2007-2010	A064825 & UP	N/A	N/A	N/A	18-7662	N/A	N/A ②
350 MAG MPI HORIZON	5.7L	350	V-8	2002-2007	M300000 - A064824	18-7688	18-7701	18-7700	18-7662	N/A	N/A ②
350 MAG MPI HORIZON	5.7L	350	V-8	2007	A064825 - A299999	N/A	18-7701	18-7700	18-7662	N/A	N/A ②
350 MAG MPI HORIZON DTS	5.7L	350	V-8	2005-2007	W310000 - A064824	18-7688	N/A	N/A	18-7662	N/A	N/A ②
350 MAG MPI HORIZON DTS	5.7L	350	V-8	2007	A064825 - A299999	N/A	N/A	N/A	18-7662	N/A	N/A ②
350 MAG MPI HORIZON MIE	5.7L	350	V-8	1999-2001	L304700 - M299999	N/A	18-7697	18-7757	N/A	N/A	N/A
350 MAG MPI HORIZON MIE	5.7L	350	V-8	2002-2004	M300000 - M398371	18-7688	18-7701	18-7700	18-7662	N/A	N/A ②
350 MAG MPI HORIZON MIE	5.7L	350	V-8	2004-2007	M398372 - A064824	18-7688	18-7701	18-7700	18-7662	N/A	N/A ②
350 MAG MPI HORIZON MIE	5.7L	350	V-8	2007	A064825 - A089999	N/A	18-7701	18-7700	18-7662	N/A	N/A ②
350 MAG MPI HORIZON MIE DTS	5.7L	350	V-8	2005-2007	W390000 - A064824	18-7688	N/A	N/A	18-7662	N/A	N/A ②
350 MAG MPI HORIZON MIE DTS	5.7L	350	V-8	2007	A064825 - A089999	N/A	N/A	N/A	18-7662	N/A	N/A ②
350 MAG MPI MIE	5.7L	350	V-8	1998	L002008 - L302199	N/A	18-7697	18-7700	N/A	N/A	N/A
350 MAG MPI MIE	5.7L	350	V-8	1999-2001	L302200 - M299999	N/A	18-7697	18-7757	N/A	N/A	N/A
350 MAG MPI MIE	5.7L	350	V-8	2002-2004	M300000 - M398371	18-7688	18-7701	18-7700	18-7662	N/A	N/A ②
350 MAG MPI MIE	5.7L	350	V-8	2004-2007	M398372 - A064824	18-7688	18-7701	18-7700	18-7662	N/A	N/A ②
350 MAG MPI MIE	5.7L	350	V-8	2007	A064825 - A089999	N/A	18-7701	18-7700	18-7662	N/A	N/A ②
350 MAG MPI MIE DTS	5.7L	350	V-8	2005-2007	W390000 - A064824	18-7688	N/A	N/A	18-7662	N/A	N/A ②
350 MAG MPI MIE DTS	5.7L	350	V-8	2007	A064825 - A089999	N/A	N/A	N/A	18-7662	N/A	N/A ②
350 MAG EFI SKI	5.7L	350	V-8	1994-1996	F215561 - F820706	18-7685	18-7632	18-7630	N/A	N/A	18-7684
350 MAG MPI SKI	5.7L	350	V-8	1998	L002600 - L304599	N/A	18-7697	18-7700	N/A	N/A	N/A
350 MAG MPI SKI	5.7L	350	V-8	1999-2001	L304600 - M299999	N/A	18-7697	18-7757	N/A	N/A	N/A
350 MAG MPI SKI	5.7L	350	V-8	2002-2007	M300000 - A064824	N/A	18-7701	18-7700	18-7662	N/A	N/A ②

① BRAVO APPS WSN W060000, ORDER REGULATOR # 892681 ② MAPT SENSOR (TEMP & PRESSURE)



18-7627
INTAKE MANIFOLD
 Small-block GM with vortec cylinder heads



18-7628
INTAKE MANIFOLD
 Small-block GM with vortec cylinder heads with brass lined water jackets

ALL SIERRA CARBURETORS INCLUDE BASE GASKET

- Precision remanufactured to meet or exceed OEM specifications
- Re-calibrated and re-engineered to maximize fuel efficiency and performance
- All carburetors are flow tested throughout the entire throttle range
- Fuel mixture and idle settings are pre-set to ensure that only minor idle and choke adjustments are necessary during installation
- All bases are resurfaced and throttle shaft bushings replaced



18-7373N
MERCARB 2V CARBURETOR
 Replaces: Mercruiser 3310-864941A01
 2002-2004 4.3L engines (s/n OM615000-OW300012)



18-7615N
Q-JET CARBURETOR
 Replaces: 1347-816373A4,
 1347-804624R1, 1347-804624R02



18-7639
CARBURETOR
 Replaces: 3310-864943A01
 Mercarb-5.7L 2V 1998 and newer 5.7L
 (OL010337-OW300754) & 5.7L MIE
 (OL002003-OW090899)
(Remanufactured)



18-7640
CARBURETOR
 Universal Q-jet with electric choke
(Remanufactured)



18-7603-1
CARBURETOR
 2 Barrel - Rochester
 Replaces: 1347-818622,
 1376-5659A1, 1347-818622 1,
 1347-818622R02
(Remanufactured)



18-7604-1
CARBURETOR
 4 Barrel - Rochester
 Replaces: 3304-9354A2,
 1347-804623R02
(Remanufactured)



18-7605-1
CARBURETOR
 4 Barrel - Rochester
 Replaces: 1347-9661A3,
 1347-804623A1,
 1347-804623R02
(Remanufactured)



18-7608-1
CARBURETOR
 2 Barrel - Rochester
 Replaces: 1347-818620,
 1347-818620 1, 1347-818620R02
(Remanufactured)



18-7609-1
CARBURETOR
 2 Barrel - Rochester
 Replaces: 1347-818619,
 1347-818619 1, 1347-818619 1R
(Remanufactured)









18-7610-1
CARBURETOR
 2 Barrel - Rochester
 Replaces: 1347-818621, 1347-818621 1,
 1347-818621 1R02
(Remanufactured)



18-7611-2
CARBURETOR
 2 Barrel - Rochester
 Replaces: 3310-807312A1,
 3310-807312R02
(Remanufactured)

ALL SIERRA CARBURETORS INCLUDE BASE GASKET

 <p>18-7613-1 CARBURETOR 4 Barrel - Carter (Weber) Replaces: 3310-806969A1, 3310-806969R01 (Remanufactured)</p>	 <p>18-7615-1 CARBURETOR 4 Barrel - Rochester Replaces: 1347-816373A4, 1347-804624R1, 1347-804624R02 (Remanufactured)</p>	 <p>18-7616-1 CARBURETOR 4 Barrel - Rochester Replaces: 1347-8288A1, 1347-804626R02 (Remanufactured)</p>
 <p>18-7617-1 CARBURETOR 4 Barrel - Rochester Replaces: 1347-9863A3, 1347-804624R1, 1347-804625R02 (Remanufactured)</p>	 <p>18-7618-1 CARBURETOR 4 Barrel - Rochester Replaces: 1347-8289A1, 1347-804624R1, 1347-804624R02 (Remanufactured)</p>	 <p>18-7619-1 CARBURETOR 4 Barrel - Rochester Replaces: 1347-9142A2, 1347-8460A3 (Remanufactured)</p>

CARBURETOR APPLICATION

Model	CID / # Cyl	Year Range	Beginning Serial #	Ending Serial #	Original Carb Part Number	Carb Code / Model	Carb Repair Kit	Replacement O.E. Carb. Number	Float	Sierra Carb #
90	96/L4	1970-1971	2851424	3225967	1351- 4263A 1	7040082 R2/2GC	18-7746	1347-818619R02	18-7200	18-7609-1
90	96/L4	1972	3225868	3226957	1351- 4263A 1	7036543 R2/2GC	18-7746	1347-818619R02	18-7200	18-7609-1
110	153/L4	1963-1966	1357370	2044033	1336-2076	R2/2GC	—	—	—	18-7609-1
120	153/L4	1972-1973	3377341	3770649	1351-4263A3	7043182 R2/2GC	18-7746	1347-818619R02	18-7200	18-7609-1
120	153/L4	1974-1975	3770650	4469865	1351-5202A1	7044182 R2/2GC	18-7746	1347-818619R02	18-7200	18-7609-1
120	153/L4	1976-1978	4469866	5192048	1351-6065A2	7044182 R2/2GC	18-7746	1347-818619R02	18-7200	18-7609-1
120	153/L4	1979-1982	5192049	6229717	1351-7354A1	17059054 R2/2GC	18-7746	1347-818619R02	18-7200	18-7609-1
120	153/L4	1983	6229718	6663797	1351- 8480A 2	17081060 R2/2GC	18-7746	1347-818621R02	18-7200	18-7610-1
120	153/L4	1984	6663798	6853913	1389- 8490A 2	M2/MERCARB	18-7097	3310-860070A 2	18-7202	—
120	153/L4	1985	6853914	A492055	1389- 9350A 2	M2/MERCARB	18-7097	3310-860070A 2	18-7202	—
120	153/L4	1986	A492056	B531853	1389- 9562A 1	M2/MERCARB	18-7098-1	3310-860070A 2	18-7202	—
2.5L	153/L4	1983-1989	B531854	C853255	3310-806077A 2	M2/MERCARB	18-7098-1	3310-860070A 2	18-7202	—
140	181/L4	1968-1969	2508261	2816416	1351- 3635A 1	7036646 R/2GC	18-7746	—	18-7200	—
140	181/L4	1970	2816417	2911439	1351- 4032A 1	7040080 R/2GC	18-7746	1347-818620R02	18-7200	18-7608-1
140	181/L4	1970-1973	2911440	3771644	1351-4293A1	7040084 R/2GC	18-7746	1347-818620R02	18-7200	18-7608-1
140	181/L4	1974-1978	3771645	5157668	1351-5203A1	7043184 R/2GC	18-7746	1347-818620R02	18-7200	18-7608-1
140	181/L4	1979-1982	5157669	6229717	1351-7355A1	17059052 R/2GC	18-7746	1347-818620R02	18-7200	18-7608-1
140	181/L4	1983	6229718	6671328	1351- 8480A 2	17081060 R/2GC	18-7746	1347-818521R02	18-7200	—
140	181/L4	1984	6671329	6852269	1389- 8490A 2	M2/MERCARB	18-7097	3310-860070A 2	18-7202	—
140	181/L4	1985	6852270	A484072	1389- 9350A 2	M2/MERCARB	18-7097	3310-860070A 2	18-7202	—
140	181/L4	1986	A484073	B450800	1389- 9562A 1	M2/MERCARB	18-7098-1	3310-860070A 2	18-7202	—
140/3.0L	181/L4	1983-1989	6229718	C856556	1351-8480A2	R2/2GC	—	1348-818621 1	—	18-7610-1
3.0L	181/L4	1987-1989	B450801	C856556	3310-806077A 2	M2/MERCARB	18-7098-1	3310-860070A 2	18-7202	—
3.0L	181/L4	1990	C856559	D447414	1389-815396A 2	M2/MERCARB	18-7098-1	3310-860070A 2	18-7202	—
3.0L	181/L4	1991-1993	D447415	D836075	1389-806077A 2	M2/MERCARB	18-7098-1	3310-860070A 2	18-7202	—
3.0L	181/L4	1993-1994	D836076	F603999	1389-806078A 1	M2/MERCARB	18-7098-1	3310-860070A 2	18-7202	—
3.0L	181/L4	1998-2002	L010042	M385672	3310-807504A 1	M2/MERCARB	18-7098-1	3310-8M0045397	18-7202	—
3.0L	181/L4	2003-2004	M385673	W301999	3310-864940A01	M2/MERCARB	18-7098-1	3310-8M0045397	18-7202	—
3.0L	181/L4	1999-2004	L382122	W301999	3310-864940A01	M2/MERCARB	18-7098-1	865959A01	18-7202	⑤
3.0L	181/L4	2004-2010	W302000	& UP	3310-866140A02	M2/MERCARB	18-7098-1	3310-866140A02	18-7202	—
3.0LX	181/L4	1990-1997	C856559	K999999	1389-815397A 2	M2/MERCARB	18-7098-1	3310-8M0045397	18-7202	—
3.0LX	181/L4	1990-1997	C856559	K999999	3310-805924A 2	M2/MERCARB	18-7098-1	3310-8M0045397	18-7202	—
165 (4 CYL)	224/L4	1987	B434941	B774251	1389- 9564A 1	M2/MERCARB	18-7098-1	3310-860071A 2	18-7202	—
170	224/L4	1985-1989	6916779	B434940	1389- 9564A 1	M2/MERCARB	18-7098-1	3310-860071A 2	18-7202	—
180	224/L4	1987	B436391	B775248	1347- 9142A 2	17083522 R4/4ME	18-7077	—	18-7201	—
190 (4 CYL)	224/L4	1985-1986	6916779	B436390	1347- 9142A 2	17083522 R4/4ME	18-7077	—	18-7201	—
3.7L	224/L4	1988-1989	B774252	& UP	1389- 9564A 1	M2/MERCARB	18-7098-1	3310-860071A 2	18-7202	—

- ① Automatic Choke
- ② Black
- ③ Blue
- ④ Electric Choke
- ⑤ Front (Blue)

- ⑥ On-Line
- ⑦ Rear (Blue)
- ⑧ Spacer Mounted
- ⑨ Use if original carb is MERCARB
- ⑩ Use if original carb is Rochester

- ⑪ Use with in-line transmission
- ⑫ Use with V-drive transmission
- ⑬ V-drive
- ⑭ Wedge mounted
- ⑮ TKS Retrofit Kit

CARBURETOR APPLICATION

Table with 12 columns: Model, CID / # Cyl, Year Range, Beginning Serial #, Ending Serial #, Original Carb Part Number, Note, Carb Code / Model, Carb Repair Kit, Replacement O.E. Carb. Number, Float, Note, Sierra Carb #. Rows include various engine models like 3.7LX, 470, 485, etc., with associated serial numbers and carburetor specifications.

- ① Automatic Choke
② Black
③ Blue
④ Electric Choke
⑤ Front (Blue)

- ⑥ On-Line
⑦ Rear (Blue)
⑧ Spacer Mounted
⑨ Use if original carb is MERCarb
⑩ Use if original carb is Rochester

- ⑪ Use with in-line transmission
⑫ Use with V-drive transmission
⑬ V-drive
⑭ Wedge mounted
⑮ TKS Retrofit Kit

CARBURETOR APPLICATION

Model	CID / # Cyl	Year Range	Beginning Serial #	Ending Serial #	Original Carb Part Number	Note	Carb Code / Model	Carb Repair Kit	Replacement O.E. Carb. Number	Float	Note	Sierra Carb #
7.4L BRAVO III	454/V-8	1996-1997	F800700	K999999	3310-806969A1		9780 WEBER	18-7748	3310-806969A 1	—		18-7613-1
7.4L MIE	454/V-8	1988-1992	5889914	D715493	1347- 8268A 1		17080560 R4/4MV	18-7077	1347-804626R02	18-7201		18-7616-1
460	482/V-8	1983-1986	4179554	B485220	1393- 8862A 1		H4	18-7751	—	—		—
465	502/V-8	1990-1992	C849992	F213244	—		H4	18-7751	—	—	②	—
465	502/V-8	1990-1992	C849992	F213244	—		H4	18-7751	—	—	③	—
500	502/V-8	1994-1995	F213293	F615766	13549A12		H4	18-7751	—	—	③	—
500	502/V-8	1996-1998	F615767	L001772	13549A 15		H4	18-7751	—	—	③	—
500 (GEN +)	502/V-8	1999	L414639	L601036	13549T21		H4	18-7751	—	—	③	—
502 MAG	502/V-8	1990-1992	C878221	D824588	1347-814623A 2		17089112 R4/4MV	18-7077	—	18-7201		—
502 MAG	502/V-8	1992-1993	D824589	F114528	3310-806971A 1		9782 WEBER	18-7748	—	—		—
8.2L MIE	502/V-8	1990-1992	C878221	D857199	1347-814623A 2		17089113 R4/4MV	18-7077	—	—		—
8.2L MIE	502/V-8	1990-1992	C878221	D857199	3310-817693A 1		9774 WEBER	18-7748	—	—		—
8.2L MIE	502/V-8	1993-1996	D857200	F819619	3310-806971A 1		9782 WEBER	18-7748	—	—		—
500 BULLDOG	540/V-8	1990-1995	C577254	F348987	13549A10		H4	18-7751	—	—	③	—
500 BULLDOG	540/V-8	1995-2001	F615762	M050281	13549A23		H4	18-7751	—	—	③	—

- ① Automatic Choke
- ② Black
- ③ Blue
- ④ Electric Choke
- ⑤ Front (Blue)

- ⑥ On-Line
- ⑦ Rear (Blue)
- ⑧ Spacer Mounted
- ⑨ Use if original carb is MERCarb
- ⑩ Use if original carb is Rochester

- ⑪ Use with in-line transmission
- ⑫ Use with V-drive transmission
- ⑬ V-drive
- ⑭ Wedge mounted
- ⑮ TKS Retrofit Kit

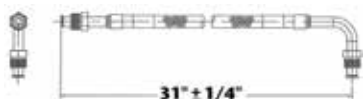

**18-8114
FUEL LINE HOSE**

For fuel pump to carburetor connection. Replaces copper or steel tubing 3/8" X 31" PTFE composite hose with 5/8"-18 male inverted flare straight one end, 5/8"-18 90° one end. SAE J1527 type A1

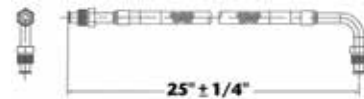

**18-8115
FUEL LINE HOSE**

For fuel pump to carburetor connection. Replaces copper or steel tubing 3/8" X 25" PTFE composite hose with 5/8"-18 male inverted flare straight one end, 5/8"-18 90° one end. SAE J1527 type A1



**18-7751
CARB KIT**
Replaces: 13220

Fits: GM 420 V8 454 (1987-89), GM 425 V8 454 (1990-93), GM 425 (Gen V) V8 454 (1992-93), 440 TRS GM 454 (1983-86), GM 450 V8 454 (1995-96), 460 TRS V8 482 (1983-86), GM 465 V8 502 (1990-92), GM 465 (Gen V) V8 502 (1992-94), 500 (Gen+) GM 502 V8 (1999), 500 (Gen V) 502 V8 (1994-98), 500 Bulldog 540 V8 (1990-01)



**18-7071
CARB KIT**
Replaces: 1397-3458



**18-7075
CARB KIT**
Replaces: 1397-5830, 1397-7099, 1397-8760, 1397-5831



**18-7070
CARB KIT**
Replaces: 1397-2072, 1397-7542, 1397-2637, 1397-7543, 1397-8872, 1397-3464,



18-7072
CARB KIT
 Replaces: 1397-3306, 1397-4329,
 1397-5635, 1397-6638, 823426A1

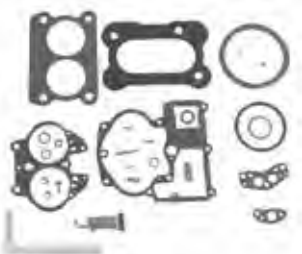

18-7076
CARB KIT
 Replaces: 1397-6367, A1



18-7077
CARB KIT
 Replaces: 1397-8952, 823426A1



18-7078
CARB KIT
 Replaces: 1397-2605



18-7080
CARB KIT
 Replaces: 1398-3089



18-7081
CARB KIT
 Replaces: 1396-4656
 Contains adjustable needles and seats



18-7095
CARB KIT
 Replaces: 1397-7539, 1397-7540,
 1397-7544, 1397-8535, 1397-9723



18-7096
CARB KIT
 Replaces: 1396-5238, 1396-5222
 Contains adjustable needles and seats



18-7097
CARB KIT
 Replaces: 3302-9437, 3302-804845
 MerCarb 2 bbl. bottom fill accelerator pump 1983-1986
 MCM 120, 140, 470, 185, 200, 898.

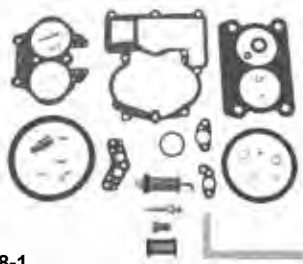

18-7098-1
CARB KIT
 Replaces 3302-804844002
 MerCarb 2 bbl. side fill accelerator pump
 1986 and UP MCM 4-cyl., V6 & V8



18-7728
CARB KIT



18-7749
CARB KIT
 Replaces: 809065, 835076, 823728



18-7748
CARB KIT
 Replaces: 809064

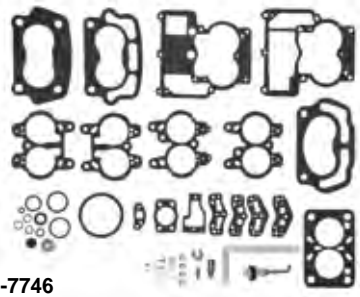

18-7746
CARB KIT
 Replaces: 823427A1
 Repair Kit for 2 BBL Rochester



18-7200
FLOAT
 Replaces: 1397-2060
(Alcohol Resistant)
 Plastic



CARBURETOR KIT/FLOAT APPLICATION

Model & Serial #	Mercruiser Carb. #	Mfg. Carb. #	Carb. Code & Model	Carb. Kit ①	Float
MCM 80 ALL	1346-2770	RBS-4394S	C1/RBS	18-7080	—
MCM 90					
3225967 & BELOW	1351-4263A1	7040082	R2/2GC	18-7746	18-7200
3225968 & ABOVE	1351-4263A2	7041369	R2/2GC	18-7746	18-7200
MCM110 ALL	1336-2076	7036543	R2/2GC	18-7070	18-7200
MCM 120/2.5L					
2520424 & BELOW	1336-2076	7036543	R2/2GC	18-7746	18-7200
2520425-3377340	1336-3594A1	7036543	R2/2GC	18-7746	18-7200
3377341-3770649	1351-4263A3	7041369	R2/2GC	18-7746	18-7200
3770650-4469865	1351-5202A1	7043182	R2/2GC	18-7746	18-7200
4469866-5192047	1351-6065A2	7044182	R2/2GC	18-7746	18-7200
5192048-6229717	1351-7354A1	17059054	R2/2GC	18-7746	18-7200
6229718 & ABOVE	1351-8480A2	17081060	R2/2GC	18-7746	18-7200
6229718 & ABOVE	1389-8490A2	N/A	M2/Mercarb	18-7097	18-7202
6229718 & ABOVE	1389-9350A2	N/A	M2/Mercarb	18-7097	18-7202
6229718 & ABOVE	1389-9562A1	N/A	M2/Mercarb	18-7098-1	18-7202
MCM 140 /3.0L/3.0LX(4 cyl.)					
2816416 & BELOW	1351-3635A1	7036646	R2/2GC	18-7746	18-7200
2816417-3332137	1351-4032A1	7040080	R2/2GC	18-7746	18-7200
3332138-3771644	1351-4293A1	7040084	R2/2GC	18-7746	18-7200
3771645-5157668	1351-5203A1	7043184	R2/2GC	18-7746	18-7200
5157669-6229717	1351-7355A1	17059052	R2/2GC	18-7746	18-7200
6229718-C856558	1351-8480A2	17081060	R2/2GC	18-7746	18-7200
6229718-C856558	1389-8490A2	N/A	M2/Mercarb	18-7097	18-7202
6229718-C856558	1389-9350A2	N/A	M2/Mercarb	18-7097	18-7202
6229718-C856558	1389-9562A1	N/A	M2/Mercarb	18-7098-1	18-7202
C856559 & ABOVE	1389-815396A2	N/A	M2/Mercarb	18-7098-1	18-7202
C856559 & ABOVE	1389-815397A2	N/A	M2/Mercarb	18-7098-1	18-7202
MCM 140 (6 cyl)					
ALL (BC)	1338-2161	7025638	R1/BC	18-7071	—

① Does not include metering rods

CARBURETOR KIT/FLOAT APPLICATION (Cont.)

Model & Serial #	Mercruiser Carb. #	Mfg. Carb. #	Carb. Code & Model	Carb. Kit ①	Float
ALL (B)	1338-2166	7025662	R1/B	18-7071	—
MCM 150					
1823489 & BELOW	1338-2428	7024180	R1/BC	18-7071	—
1823489 & BELOW	1338-2431	7024181	R1/B	18-7071	—
1823490-1830151	1338-2608	7025183	R1/BC	18-7071	—
1823490-1830151	1338-2609	7025184	R1/B	18-7071	—
1830152 & ABOVE	1338-2633	7025188	R2/2GC	18-7070	18-7200
MCM 160					
2492035 & BELOW	1338-2991	7026088	R2/2GC	18-7746	18-7200
2492036 & ABOVE	1351-3635A1	7036646	R2/2GC	18-7746	18-7200
MCM 165 (6 cyl)					
3354701 & BELOW	1351-4282A1	7040083	R2/2GC	18-7746	18-7200
3354702-3774864	1351-4871A1	7042183	R2/2GC	18-7746	18-7200
3774865-5178958	1351-5204A1	7043183	R2/2GC	18-7746	18-7200
5178959 & ABOVE	1351-7356A1	17059050	R2/2GC	18-7746	18-7200
MCM 165/170/3.7L (4 cyl)					
6218037-6916778	1389-8489A5	N/A	M2/Mercarb	18-7097	18-7202
6916779 & ABOVE	1389-9564A1	N/A	M2/Mercarb	18-7098-1	18-7202
MCM 175/4.3L/185 (V-6) (229 CID) ALL	3304-9565A1	N/A	M2/Mercarb	18-7098-1	18-7202
A221455-D714106	3300-8886A2	17083515	R4/4MV	18-7095	18-7201
185 (262 CID)					
A221455-B527954	3304-9353A2	N/A	M2/Mercarb	18-7097	18-7202
MCM 205 (262 CID)	3304-9354A2	—	R4/4MV	18-7095	18-7201
A331455-D714369	3304-9565A1	N/A	M2/Mercarb	18-7098-1	18-7202
MCM/MIE 470 ALL	1376-5990A1	17057132	R2/2GC	18-7076	18-7202
MCM 485 ALL	1376-5990A1	17057132	R2/2GC	18-7076	18-7202
MCM 488 ALL	1347-8460A3	17081299	R4/4ME	18-7077	18-7201
MCM 888					
ALL HOLLEY	1356-4642	D1JJ-9510-8	H2/2300	18-7081	18-7206
ALL ROCHESTER	1376-5659A1	7044185	R2/2GC	18-7075	18-7202
MCM 180/190/3.7LX					
(4 cyl)	1347-9142A2	17083522	R4/4MV	18-7095	18-7201
MIE 198/200/5.0L					
6021383 & BELOW	1376-6491A1	17057139	R2/2GV	18-7075	18-7202
6021384 & ABOVE	1376-8295A3	17080350	R2/2GV	18-7075	18-7202
MCM 200 (6 cyl)					
2494935 & BELOW	1347-3237A2	7037082	R4/4MV	18-7072	18-7201
2494936 & ABOVE	1347-3237A4	7037082	R4/4MV	18-7072	18-7201
MCM 898/200/5.0L					
6218462 & ABOVE	1389-8488A2	N/A	M2/Mercarb	18-7097	18-7202
6218462 & ABOVE	1389-9563A1	N/A	M2/Mercarb	18-7098-1	18-7202
6218462 & ABOVE	1389-9670A2	N/A	M2/Mercarb	18-7098-1	18-7202
MCM 205/4.3LX (V-6 262 CID)					
A331455-D714369	3304-9354A2	17084516	R4/4MV	18-7095	18-7201
MCM/MIE 215 ALL	1356-4066	C9FF-9510-E	H4/4160	18-7096	18-7206
MCM/MIE 225 (FORD)					
ALL	1356-5155	D2JL-9510-C	H4/4160	18-7096	18-7206
MCM/MIE 225 (GM)	1337-2103	7025564	R4/4GC	18-7078	—
1536920-2694014	1337-2604	7025756	R4/4GC	18-7078	—
	1347-3353	7037082	R4/4MV	18-7072	18-7201
	1347-3237A3	7037082	R4/4MV	18-7072	18-7201
MCM 228					
5069430 & BELOW	1347-6427A1	17057282	R4/4MV	18-7072	18-7201
MCM 228TR/ MIE 228					
5069430 & BELOW	1347-6438A1	17057283	R4/4MV	18-7072	18-7201
MCM 228/230/5.0L					
5069431-6021783	1347-7361A1	17059292	R4/4MV	18-7095	
6021784-6218461	1347-8296A4	17080565	R4/4MV	18-7095	18-7201
6218462 & ABOVE	1347-9661A3	—	R4/4MV	18-7095	18-7201
MIE 228					
5067431-6040745	1347-7364A1	17059291	R4/4MV	18-7095	18-7201

① Does not include metering rods

CARBURETOR KIT/FLOAT APPLICATION (Cont.)

Model & Serial #	MerCruiser Carb. #	Mfg. Carb. #	Carb. Code & Model	Carb. Kit ①	Float
6040746 & ABOVE	1347-8290A1	17080564	R4/4MV	18-7095	18-7201
MIE 230/5.0L ALL	1347-8290A1	17080564	R4/4MV	18-7095	18-7201
230/5.0LX	1347-9661A3	—	R4/4MV	18-7095	18-7201
MCM/MIE 233					
4465029 & BELOW	1376-5744A1	7044187	R2/2GC	18-7075	18-7202
4465030 & ABOVE	1376-6152A1	17056197	R2/2GC	18-7075	18-7202
MCM/MIE 250 AUTO. CHOKE					
4767999 & BELOW	1347-3353	7037082	R4/4MV	18-7072	18-7201
MCM/MIE 250 (EL. CHOKE)					
4767999 & BELOW	1347-3237A3	7037082	R4/4MV	18-7072	18-7201
MCM 250					
4768000 & ABOVE	1347-6492A1	17057298	R4/4MV	18-7072	18-7201
MCM/MIE 255 (GM)					
4924564 & BELOW	1347-5732A1	7044291	R4/4MV	18-7072	18-7201
4924565-5195908	1347-7062A1	17057295	R4/4MV	18-7072	18-7201
5195909-5907067	1347-7365A1	17059289	R4/4MV	18-7095	18-7201
5907068 & ABOVE	1347-8289A1	17080562	R4/4MV	18-7095	18-7201
MCM/MIE 255 (FORD)					
ALL	1356-5169	D2JL-9510E	H4/4160	18-7096	18-7206
MCM 260/5.7L BRAVO					
5060805 & BELOW	1347-6492A1	17057298	R4/4MV	18-7072	18-7201
5060806-6024393	1347-7362A1	17059288	R4/4MV	18-7095	18-7201
6024394-B525981	1347-8292A4	17080561	R4/4MV	18-7095	18-7201
B525982 & ABOVE	1347-9662A4	—	R4/4MV	18-7095	18-7201
MIE 260/5.7L 350 MAG					
A635178-D617327	1347-8289A1	17080562	R4/4MV	18-7095	18-7201
MIE 5.7 SKI					
A339533-F205099	1347-9415T	17085013	R4/4MV	18-7095	18-7201
MCM/MIE 270 ALL	1347-4180A1	7029285	R4/4MV	18-7072	18-7201
MCM 280					
4176468 & BELOW	1347-4179A2	7040283	R4/4MV	18-7072	18-7201
4176469 & ABOVE	1347-5981A1	7044290	R4/4MV	18-7072	18-7201
MCM 300 MR/TRS (GM)					
6668677 & ABOVE	1347-7498A7	—	R4/4MV	18-7095	18-7201
MCM/MIE 325 AUTO. CHOKE					
3042730 & BELOW	1347-3342	7027080	R4/4MV	18-7072	18-7201
3042731 & ABOVE	1347-4533A1	7041831	R4/4MV	18-7072	18-7201
MCM/MIE 325 EL. CHOKE					
2278747-378099	1347-3689A1	7029280	R4/4MV	18-7072	18-7201
MCM 330/454 MAGNUM (ALPHA ONE)					
5027230 & BELOW	1347-6493A1	17057287	R4/4MV	18-7072	18-7201
5027231-6083144	1347-7363A1	17059290	R4/4MV	18-7095	18-7201
6083145 & ABOVE	1347-8291A3	17080563	R4/4MV	18-7095	18-7201
MIE 330					
5226384 & BELOW	1347-6493A1	17057287	R4/4MV	18-7072	18-7201
5226385 & ABOVE	1347-7366A1	17059287	R4/4MV	18-7095	18-7201
MIE 340/7.4L					
ALL	1347-8288A1	17080560	R4/4MV	18-7095	18-7201
MCM 350 MAGNUM/5.7L BRAVO					
B525992-317327	1347-8289A1	—	R4/4MV	18-7095	18-7201
MIE 350 ALL	1347-5326A2	17065977	R4/4MV	18-7072	18-7201
MCM 370/400 ALL	1347-7498A2	17059280	R4/4MV	18-7095	18-7201
MCM 7.4L (BRAVO ONE)	1347-8291A3	17080563	R4/4MV	18-7095	18-7201
MCM 454 7.4L					
6083145-B816540	—	—	H4/4150, R6647A	18-7728	—
MCM 454 MAGNUM (BRAVO ONE)					
ALL	1347-7498A2	17059280	R4/4MV	18-7095	18-7201
ALL	1347-9863A3	—	R4/4MV	18-7095	18-7201
MCM 502 MAGNUM (BRAVO ONE)					
C878221-D857199	1347-814623A2	—	R4/4MV	18-7095	18-7201
MCM 8.2L	1347-814623A2	—	R4/4MV	18-7095	18-7201

① Does not include metering rods



**18-7228
FLAME ARRESTOR**
Replaces: 85784A1,805016A1



**18-7229
FLAME ARRESTOR**
Replaces: 85785T, 85785-2



**18-7230
FLAME ARRESTOR**
Replaces: 41639A-1, 41639



**18-7231
FLAME ARRESTOR**
Replaces: 85785A2



**18-7232
FLAME ARRESTOR**
Replaces: 57882, 57882T



**18-7234
FLAME ARRESTOR**
Replaces: 805016A1

**ANODIZED ALUMINUM
FLAME ARRESTOR SPECIFICATIONS**

ENGINE	PART NO.	HEIGHT A	ELEMENT B	THROAT C	VENT TUBES*
4 & 6 cyl.	18-7228	2.156	1.088	3.120	1
4 & 6 cyl.	① 18-7234	2.280	1.550	3.100	0
V-8	18-7229	2.250	1.470	5.050	0
V-8	18-7230	2.250	1.470	5.050	1
V-8	18-7231	2.250	1.470	5.050	2
Hi-Performance	18-7232	2.969	2.190	5.050	2

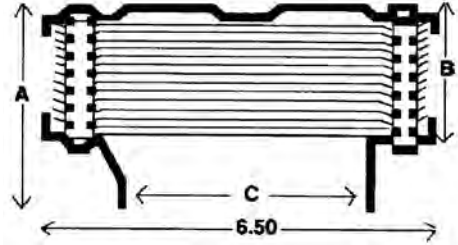

① 7" Outside diameter * Vent tubes accept 5/8 inch ID hose

ALL SIERRA FUEL PUMPS INCLUDE MOUNTING GASKET



**18-8861
FUEL PUMP W/ COOLER**
Replaces: 861156A02
For: GM V-6/ V-8 EFI 0L000000-0M299999



**18-8862
FUEL PUMP W/ COOLER**
Replaces: 861156A03
For: GM V-6/ V-8 EFI 0M300000



**18-8863
FUEL PUMP W/ COOLER**
Replaces: 861156A04
For: GM V-6/ V-8 engines with cool fuel 0K999999 & below



**18-8864
FUEL PUMP W/ REGULATOR**
Replaces: 866169T01
For: Gm V-8 with Gen III Cool Fuel Module-high pressure



**18-8865
FUEL PUMP**
Replaces: 866170A01
For: Gm V-8 with Gen III Cool Fuel Module-low pressure



**18-8867
FUEL PUMP**
Replaces: 861155A6
For: 4.3L V-6



**18-8868
FUEL PUMP**
Replaces: 861155A3
For: 5.0/ 5.7L V-8



**18-8860
FUEL PUMP**
Replaces: 861677T
For: GM V-8 (454 & 502) applications



**18-7256
FUEL PUMP**
Flange I.D. # 6790,M3530
Replaces: 32722
For: GM (4 & 6 Cyl.)153, 230, 250, 292



**18-7266
FUEL PUMP**
Flange I.D. # 41413, M6696
For: Ford (V-8) 302, 351



**18-7267
FUEL PUMP**
Flange I.D. # 41414
Replaces: 62092,T
For Ford (V-8) 302



**18-7274
FUEL PUMP**
Flange I.D. # 41421, M73021
Replaces: 86246
For: GM (V-8) 305, 350, 400, 228 / 250 / 255 / 260 / 280



**18-7275
FUEL PUMP**
Flange I.D. # 41422
Replaces: 86247,T
For: GM (V-8) 454, 330 / 325 / 350 / 390



**18-7278
FUEL PUMP**
Flange I.D. # M60032
Replaces: 86234A4, 86234A05
For: GM (4 & 6 Cyl.) 153, 181, 225, 250, 120 / 140 / 160 / 165 / 470 / 485 / 488



**18-7282
FUEL PUMP**
Flange I.D. # M60337
Replaces: 42725A3
For: GM (V-6) 225, 170 / 180 / 190



**18-7283
FUEL PUMP**
Flange I.D. # M60600
Replaces: 97401A2, 97401A2A8, 861678A1
For: GM (V-8) 305, 350, 228 / 230 / 260 / 898



**18-7284
FUEL PUMP**
Flange I.D. # M60315
Replaces: 41141A2,862077A1
For: GM (V-6) 231, 262, 229



**18-7288-1
FUEL PUMP**
Flange I.D. #60601
Replaces: 812454A1, 862048A1
For: Inline (4 cyl) 120, 140, 3.0L and 224 CID 7.4L / 454 / 420 / 330



**18-7326
ELECTRIC FUEL PUMP**
Replaces: 805656A2
For: 1992-93, 1996
F.I. & Carbureted 4.3L
with inline electric pump

APPLICATION ON NEXT PAGE

FUEL PUMP APPLICATION

Model	CID / # CYL	Year Range	Beginning Serial Number	Ending Serial Number	Fuel Pump #1	Fuel Pump #2	Pump Filter
120	153/L4	1964-1972	1666601	3377340	18-7278	①	18-7860
120	153/L4	1964-1972	1666601	3377340	18-7256	②	—
120	153/L4	1972-1982	3377341	6229717	18-7278	—	18-7860
120	153/L4	1983-1986	6229718	B531853	18-7278	③	18-7860
120			4469866	& Below	18-7278	—	—
120			4469866	4952700	18-7278	—	—
120			4952701	& Up	18-7278	—	—
120			5192049	6229717	18-7278	—	—
120/2.5L			6229718	& Up	18-7278	—	—
120/2.5L			6229718	& Up	18-7282	—	—
2.5L	153/L4	1987-1989	B531854	BC853255	18-7278	④	18-7860
140 (4 CYL)	181/L4	1968-1982	2508261	6229717	18-7278	—	18-7860
140 (4 CYL)	181/L4	1983-1986	6229718	B450800	18-7278	⑤	18-7860
3.0L	181/L4	1987-1989	B450801	C856558	18-7278	⑥	18-7860
140			4460664	& Below	18-7278	—	—
140			4460665	4918569	18-7278	—	—
140			4918570	& Up	18-7278	—	—
140 (4 Cyl.)			5157669	6229717	18-7278	—	—
140/3.0L			6229717	& Below	18-7278	—	—
140/3.0L			6229718	& Up	18-7282	—	—
3.0L/3.0LX			C856559	& Up	18-7282	—	—
140 (6 Cyl.)			1538930	1725960	18-7256	—	—
150			1666495	2048046	18-7256	—	—
160			2048022	2770031	18-7278	—	—
165			4471566	4884834	18-7278	—	—
165			5178959	& Up	18-7278	—	—
165/3.7L (4 Cyl.)			6916779	& Up	18-7282	—	—
180/3.7-LX (4 Cyl.)			6916779	& Up	18-7282	—	—
175/4.3L (262 CID)			B527955	& Up	18-7284	—	—
185 (229 CID)			6330183	& Up	18-7284	—	—
185 (262 CID)			A331455	& Up	18-7284	—	—
470	224/L4	1976-1984	4208730	6916778	18-7278	—	18-7860
485	224/L4	1980-1982	5685394	6218036	18-7278	—	18-7860
488	224/L4	1983-1984	6170297	6916778	18-7278	⑦	18-7860
140 (6 CYL)	194/L6	1963	1538930	1725960	18-7256	—	—
150	230/L6	1964-1966	1666495	2048046	18-7256	—	—
160	250/L6	1967-1969	2048022	2770031	18-7278	⑧	18-7860
160	250/L6	1967-1969	2048022	2770031	18-7256	⑨	—
165 (6 CYL)	250/L6	1979-1981	2770032	5813433	18-7278	—	18-7860
200 (6 CYL)	250/L6	1969	2453769	2712072	18-7278	—	18-7860
200 GM			6218462	& Up	18-7283	—	—
200/5.0L GM			B525982	& Up	18-7283	—	—
185 (4bbl)	229/V-6	1983-1984	6330183	6919655	18-7284	—	—
175	262/V-6	1987	B527955	B773242	18-7284	—	—
185 (2bbl)	262/V-6	1985-1986	A331455	B527954	18-7284	—	—
205	262/V-6	1985-1987	A331455	B775129	18-7284	—	—
205/4.3L-LX (262 CID)			B527955	& Up	18-7284	—	—
262 MAG EFI (GEN +)	262/V-6	1996-1997	F803800	K999999	18-8867	—	—
4.3L	262/V-6	1988-1992	B773243	D714106	18-7284	—	—
4.3L (GEN II)	262/V-6	1992-1996	D714107	F802999	18-8867	—	—
4.3L (GEN +)	262/V-6	1998-2010	L012009	& Up	18-8868	—	—
4.3L EFI (GEN +)	262/V-6	1998-2001	L012009	M299999	18-8861	⑩	—
4.3L MPI	262/V-6	2002-2010	M300000	& Up	18-8862	⑪	—
4.3LH (GEN+)	262/V-6	1998-2002	L010044	M614999	18-8868	—	—
4.3LX	262/V-6	1988-1992	B775130	D714369	18-7284	—	—
4.3LX (GEN II)	262/V-6	1992-1996	D714107	F802999	18-8867	—	—
4.3LX (GEN +)	262/V-6	1996-1997	F803000	K999999	18-8867	—	—
4.3LXH (GEN +)	262/V-6	1996-1997	F803114	K999999	18-8867	—	—
215 (FORD)	302/V-8	1970-1972	2781153	3563181	18-7267	—	—
215 Ford			3085036	& Below	18-7267	—	—
215 Ford			3258182	& Up	18-7267	—	—
225 Ford	302/V-8	1973-1974	3385721	4166999	18-7267	—	—
228 MCM & MIE	305/V-8	1977-1978	4765100	5170008	18-7274	—	—
228 MCM & MIE	305/V-8	1979-1982	5170009	6218461	18-7274	—	—
228 MCM & MIE	305/V-8	1979-1982	5170009	6218461	18-7283	⑫	—
888 (FORD)	302/V-8	1971-1977	3108723	4887829	18-7267	—	—
228	305/V-8	1982-1984	6218462	6899268	18-7283	—	—
230 MIE	305/V-8	1981-1987	5907058	B788151	18-7283	—	—
230/5.0L-GM (IB)			B522506	& Up	18-7283	—	—
230 GM			6218462	& Up	18-7283	—	—
230/5.0L-LX GM			B525982	& Up	18-7283	—	—
230	305/V-8	1985-1987	6899269	B773739	18-7283	—	—
5.0L	305/V-8	1988-1995	B774445	F600999	18-7283	—	—
5.0L (GEN +)	305/V-8	1998-2010	L015751	& Up	18-8868	—	—
5.0L EFI (GEN +)	305/V-8	1998-2001	L012052	M299999	18-8861	⑬	—
5.0L MIE	305/V-8	1988	B788152	C396832	18-7283	—	—
5.0L MPI ALPHA	305/V-8	2002-2010	M300000	& Up	18-8862	⑭, ⑮	18-8868 ⑯
5.0L MPI BRAVO	305/V-8	2002-2004	M300000	W059999	18-8862	⑰, ⑱	18-8868 ⑲
5.0L MPI BRAVO	305/V-8	2004-2010	W060000	& Up	18-8864	⑲	18-8865 ⑲
5.0LX	305/V-8	1988-1995	B773740	F600999	18-7283	—	—
898	305/V-8	1977-1982	4762210	6218461	18-7274	⑳	—
898	305/V-8	1977-1982	4762210	6218461	18-7283	㉑	—
898	305/V-8	1983-1984	6218462	6899057	18-7283	—	—
233 FORD			4500860	& Up	18-7267	—	—
250	350/V-8	1977	4768000	4908849	18-7274	—	—
255	350/V-8	1975-1976	4175500	4767999	18-7274	—	—
255 MIE (GM)	350/V-8	1975-1980	4175500	5907057	18-7274	—	—
255 FORD			3258728	& Up	18-7267	—	—
255 GM			5195909	& Up	18-7274	—	—
260	350/V-8	1978-1982	4908850	6218461	18-7274	㉒	—
260	350/V-8	1978-1982	4908850	6218461	18-7283	㉓	—
260	350/V-8	1983-1987	6218461	& Up	18-7283	—	—
260 MIE	350/V-8	1981-1987	5907058	B788151	18-7283	—	—

- ① low pressure lift pump
- ② high pressure fuel cool pump
- ③ fuel pump mounted with filter bowl facing up
- ④ fuel pump mounted with filter bowl facing down
- ⑤ AC fuel pump
- ⑥ Carter fuel pump
- ⑦ mechanical fuel pump
- ⑧ use if fuel pump has sight glass
- ⑨ use if fuel pump has sight tube
- ⑩ fuel pump/cooler kit

FUEL PUMP APPLICATION

Model	CID / # CYL	Year Range	Beginning Serial Number	Ending Serial Number	Fuel Pump #1	Fuel Pump #2	Pump Filter
260/5.7 GM			B525982	& Up	18-7283	—	—
260 GM Inboard			5907058	& Up	18-7283	—	—
260/5.7L GM (IB)			5907058	& Up	18-7283	—	—
5.7L-GM			F025000	& Up	18-7283	—	—
280	350/V-8	1975-1976	4176250	4770199	18-7274	—	—
300MR/TRS GM	350/V-8	1985-1986	6668677	B430367	18-7283	—	—
320 EFI	350/V-8	1987-1989	A543604	C622418	N.L.A	—	—
325-GM			2278747	3640670	18-7275	—	—
330 GM			4623115	& Up	18-7275	—	—
330 GM/W.B.W.			6083145	& Up	18-7288-1	—	—
340/7.4L-GM (IB)			5889914	& Up	18-7288-1	—	—
350 MAG ALPHA	350/V-8	1986-1997	A635178	K999999	18-7823	—	—
350 MAG ALPHA EFI (GEN +)	350/V-8	1996	F800300	K001508	18-7283	—	—
350 MAG ALPHA EFI (GEN +)	350/V-8	1997	K001509	K999999	18-8863	Ⓜ	—
350 MAG BRAVO MPI	350/V-8	1995-1996	F415189	K001500	18-7283	—	—
350 MAG BRAVO MPI	350/V-8	1997	K001501	K999999	18-8863	Ⓜ	—
350 MAG EFI SKI	350/V-8	1994-1997	F215561	K999999	18-8863	Ⓜ	—
350 MAG MPI	350/V-8	1998-2001	L010019	M299999	18-8861	Ⓜ	—
350 MAG MPI ALPHA	350/V-8	2002-2010	M300000	& Up	18-8862	Ⓜ	18-8868 Ⓜ
350 MAG MPI BRAVO	350/V-8	2002-2004	M300000	W059999	18-8862	Ⓜ, Ⓜ	18-8868 Ⓜ
350 MAG MPI BRAVO	350/V-8	2004-2010	W060000	& Up	18-8864	Ⓜ	18-8865 Ⓜ
350 MAG MPI HORIZON	350/V-8	2002-2004	M300000	W059999	18-8862	Ⓜ, Ⓜ	18-8868 Ⓜ
350 MAG MPI HORIZON	350/V-8	2004-2007	W060000	A299999	18-8864	Ⓜ	18-8865 Ⓜ
350 MAG MPI HORIZON MIE	350/V-8	1999-2001	L304700	M299999	18-8861	Ⓜ	—
350 MAG MPI HORIZON MIE	350/V-8	2002-2004	M300000	M398371	18-8862	Ⓜ, Ⓜ	18-8868 Ⓜ
350 MAG MPI HORIZON MIE	350/V-8	2004-2007	M398372	A089999	18-8864	Ⓜ	18-8865 Ⓜ
350 MAG MPI MIE	350/V-8	1998-2001	L002008	M299999	18-8861	Ⓜ	—
350 MAG MPI MIE	350/V-8	2002-2004	M300000	M398371	18-8862	Ⓜ, Ⓜ	18-8868 Ⓜ
350 MAG MPI MIE	350/V-8	2004-2007	M398372	A089999	18-8864	Ⓜ	18-8865 Ⓜ
350 MAG MPI MIE	350/V-8	1998-2001	L002008	M299999	18-8861	Ⓜ	—
350 MAG MPI MIE	350/V-8	2002-2004	M300000	M398371	18-8862	Ⓜ, Ⓜ	18-8868 Ⓜ
350 MAG MPI MIE	350/V-8	2004-2007	M398372	A089999	18-8864	Ⓜ	18-8865 Ⓜ
350 MAG MPI SKI	350/V-8	1995-1996	F350583	F799999	18-7283	—	—
350 MAG MPI SKI (GEN +)	350/V-8	1998-2001	L002600	M299999	18-8861	Ⓜ	—
350 MAG MPI SKI (GEN +)	350/V-8	2002-2007	M300000	A089999	18-8862	Ⓜ	18-8868 Ⓜ
350 MAG SKI	350/V-8	1991-1997	D505450	K999999	18-7283	—	—
350 GM			3780450	& Up	18-7275	—	—
(MAG-TOURNEY SKI)			D505450	& Up	18-7283	—	—
370 TRS-GM			6721528	& Up	18-7288-1	—	—
390-GM			2781129 - 2825059	2825059	18-7275	—	—
5.7L	350/V-8	1988-1997	B773305	K999999	18-7283	—	—
5.7L (GEN +)	350/V-8	1998-2010	L010037	& Up	18-8868	—	—
5.7L EFI	350/V-8	1995-1996	F225560	K001505	18-7283	—	—
5.7L EFI	350/V-8	1997-2001	K001506	M299999	18-8861	Ⓜ	—
5.7L MIE	350/V-8	1988-1997	B788152	K999999	18-7283	—	—
5.7L MIE (GEN +)	350/V-8	1998-2010	L002003	& Up	18-8868	—	—
5.7L MPI HORIZON MIE	350/V-8	2008-2010	A090000	& Up	18-8864	Ⓜ	18-8865 Ⓜ
5.7L MPI MIE	350/V-8	2008-2010	A090000	& Up	18-8864	Ⓜ	18-8865 Ⓜ
5.7L MPI SKI	350/V-8	2008-2010	A090000	& Up	18-8862	Ⓜ, Ⓜ	18-8868 Ⓜ
5.7L SKI	350/V-8	1985-1997	A338553	K999999	18-7283	—	—
5.7L SKI (GEN +)	350/V-8	1998-2010	L002005	& Up	18-8868	—	—
5.7LX	350/V-8	1996-1997	F601000	K999999	18-7283	—	—
5.7LX BRAVO EFI (GEN +)	350/V-8	1996	F800300	K001508	18-7283	—	—
5.7LX BRAVO EFI (GEN +)	350/V-8	1997	K001509	K999999	18-8863	Ⓜ	—
5.7LX EFI	350/V-8	1996	F752400	K001505	18-7283	—	—
5.7LX EFI	350/V-8	1997	K001506	K999999	18-8863	Ⓜ	—
5.7 GM (SKI)			B514627	& Up	18-7283	—	—
5.7L BRAVO (GM)350			B525982	& Up	18-7283	—	—
BLACK SCORPION SKI	350/V-8	1997	K040001	K999999	18-8863	Ⓜ, Ⓜ	—
BLACK SCORPION SKI	350/V-8	1998-2001	L000000	L679175	18-8861	Ⓜ, Ⓜ	—
BLACK SCORPION SKI	350/V-8	2001-2007	L679176	W698432	18-8861	Ⓜ, Ⓜ	18-8868 Ⓜ
SCORPION 350	350/V-8	2008-2010	W698433	& Up	18-8861	Ⓜ, Ⓜ	18-8868 Ⓜ
SCORPION 350 EC	350/V-8	2009-2010	W698433	& Up	18-8864	Ⓜ	18-8864 Ⓜ
233 (FORD)	351/V-8	1975-1977	4173000	4902304	18-7267	—	—
255 (FORD)	351/V-8	1973-1974	3258728	4175499	18-7267	—	—
377 MAG	377/V-8	2008-2010	A300000	& Up	18-8864	Ⓜ	18-8865 Ⓜ
377 SCORPION MCM	377/V-8	1999-2005	L416146	M907201	18-8861	Ⓜ	—
377 SCORPION SKI	377/V-8	1997-1998	K00656	L600314	18-8861	Ⓜ	—
MX 6.2L MPI	377/V-8	2000-2001	L680003	M299999	18-8861	Ⓜ	—
MX 6.2L MPI	377/V-8	2002-2004	M300000	W059999	18-8862	Ⓜ, Ⓜ	18-8868 Ⓜ
MX 6.2L MPI	377/V-8	2004-2007	W060000	A299999	18-8864	Ⓜ	18-8865 Ⓜ
MX 6.2L MPI HORIZON	377/V-8	2002-2004	M300000	W059999	18-8862	Ⓜ, Ⓜ	18-8868 Ⓜ
MX 6.2L MPI HORIZON	377/V-8	2004-2007	W060000	A299999	18-8864	Ⓜ	18-8865 Ⓜ
MX 6.2L MPI HORIZON MIE	377/V-8	2002-2004	M300000	M398394	18-8862	Ⓜ, Ⓜ	18-8868 Ⓜ
MX 6.2L MPI HORIZON MIE	377/V-8	2004-2010	M398395	& Up	18-8864	Ⓜ	18-8865 Ⓜ
MX 6.2L MPI MIE	377/V-8	2002-2004	M300000	M398394	18-8862	Ⓜ, Ⓜ	18-8868 Ⓜ
MX 6.2L MPI MIE	377/V-8	2004-2010	M398395	& Up	18-8864	Ⓜ	18-8865 Ⓜ
MX 6.2L MPI SKI	377/V-8	2002-2010	M317000	& Up	18-8862	Ⓜ, Ⓜ	18-8868 Ⓜ
MX 6.2L BLACK SCORPION SKI	377/V-8	2001	L670015	L679175	18-8861	Ⓜ	—
MX 6.2L BLACK SCORPION SKI	377/V-8	2001-2007	L679176	W698432	18-8861	Ⓜ, Ⓜ	18-8868 Ⓜ
SCORPION 377	377/V-8	2008-2010	W698433	& Up	18-8861	Ⓜ, Ⓜ	18-8868 Ⓜ
SCORPION 377 HO EC	377/V-8	2009-2010	A091488	A092170	18-8864	Ⓜ	18-8865 Ⓜ
325	427/V-8	1969-1972	2278747	3780449	18-7275	—	—
330	454/V-8	1977-1981	4623115	6083144	18-7275	—	—
330 WITH B/W	454/V-8	1982-1987	6083145	B816540	18-7288-1	—	—
340 MIE	454/V-8	1981-1987	5889914	B788365	18-7288-1	—	—
350 MIE	454/V-8	1974-1976	3780450	4623109	18-7275	—	—
370 TRS	454/V-8	1978-1987	4179554	B714586	18-7288-1	—	—
400 TRS	454/V-8	1980-1986	4179554	B457644	18-7288-1	—	—
420	454/V-8	1987-1989	A398941	B622418	18-7288-1	—	—
425-GM			A398941	& Up	18-7288-1	—	—
425	454/V-8	1990-1992	B622419	D725499	18-7288-1	—	—
425 (GEN V)	454/V-8	1992-1993	D763855	D937011	18-8860	—	—
440 TRS	454/V-8	1983-1986	4179554	B485220	18-7288-1	—	—

- Ⓜ low pressure lift pump
- Ⓜ high pressure fuel cool pump
- Ⓜ fuel pump mounted with filter bowl facing up
- Ⓜ fuel pump mounted with filter bowl facing down
- Ⓜ AC fuel pump
- Ⓜ Carter fuel pump
- Ⓜ mechanical fuel pump
- Ⓜ use if fuel pump has sight glass
- Ⓜ use if fuel pump has sight tube
- Ⓜ fuel pump/cooler kit

FUEL PUMP APPLICATION

Model	CID / # CYL	Year Range	Beginning Serial Number	Ending Serial Number	Fuel Pump #1	Fuel Pump #2	Pump Filter
450	454/V-8	1995-1996	F347100	F347277	18-8860	—	—
454 MAG ALPHA	454/V-8	1986-1988	A631894	B785148	18-7288-1	—	—
454 MAG BRAVO GM			B840126	& Up	18-7288-1	—	—
454 MAG BRAVO	454/V-8	1988-1992	A631894	B785148	18-7288-1	—	—
454 MAG BRAVO	454/V-8	1992-1997	D805069	K999999	18-8860	—	—
454 MAG EFI	454/V-8	1994-1996	F115700	F802349	18-8860	—	—
454 MAG EFI SKI	454/V-8	1995-1996	F215800	F820099	18-8860	—	—
454 MAG MPI	454/V-8	1996	F802350	K147349	18-8860	—	—
454 MAG MPI	454/V-8	1997	K147350	K999999	18-8861	Ⓜ	—
454 MAG MPI	454/V-8	1998-2001	L010029	M024999	18-8861	Ⓜ	—
454 MAG MPI HORIZON MIE	454/V-8	1998-2001	L002200	L674000	18-8861	Ⓜ	—
454 MAG MPI SKI	454/V-8	1996-1997	F820100	K999999	18-8860	—	—
470			5097479	& Below	18-7278	—	—
470			5097480	& Up	18-7278	—	—
470			5520115	6218036	18-7278	—	—
470			6218037	& Up	18-7278	—	—
485			5685394	& Up	18-7278	—	—
488			6170297	& Up	18-7278	—	—
525SC	454/V-8	1992-1999	D725809	L415623	18-8860	—	—
7.4L BRAVO	454/V-8	1988-1991	B771113	D603117	18-7288-1	—	—
7.4L BRAVO	454/V-8	1992-1997	D603118	K999999	18-8860	—	—
7.4L EFI MIE	454/V-8	1996-1997	F874815	K999999	18-8863	Ⓜ	—
7.4L MIE	454/V-8	1988-1992	B788366	D715493	18-7288-1	—	—
7.4L MIE	454/V-8	1992-1997	D715494	K999999	18-8860	—	—
7.4L MPI	454/V-8	1998-2001	L010003	M024330	18-8861	Ⓜ	—
7.4L MPI MIE	454/V-8	1995-1997	F563052	K147349	18-8860	—	—
7.4L MPI MIE	454/V-8	1997	K147350	K999999	18-8863	Ⓜ	—
7.4L MPI MIE	454/V-8	1997-2001	L002006	L674613	18-8861	Ⓜ	—
7.4LX BRAVO EFI	454/V-8	1996-1997	F820000	K999999	18-8863	Ⓜ	—
7.4LX BRAVO MPI	454/V-8	1996-1997	F602010	K999999	18-8860	—	—
7.4L W/HURTH (IB)			C391564	& Up	18-7288-1	—	—
390	482/V-8	1969-1970	2781129	2825059	18-7275	—	—
496 MAG & HO	496/V-8	2001-2004	M025000	W059999	18-8862	Ⓜ, Ⓜ	18-8868 Ⓜ
496 MAG & HO	496/V-8	2004-2010	W060000	& Up	18-8864	Ⓜ	18-8865 Ⓜ
8.1S MPI MIE & HO	496/V-8	2001-2004	M026000	W089999	18-8862	Ⓜ, Ⓜ	18-8868 Ⓜ
8.1S MPI MIE & HO	496/V-8	2004-2010	W090000	& Up	18-8864	Ⓜ	18-8865 Ⓜ
465	502/V-8	1992-1994	D456155	F213244	18-7275	—	—
500	502/V-8	1994-1998	F213293	L001772	18-7275	—	—
502 MAG BRAVO	502/V-8	1992-1993	D824589	F114528	18-8860	—	—
502 MAG EFI	502/V-8	1993-1995	D840650	F802599	18-8860	—	—
502 MAG MPI	502/V-8	1996	F802600	K147349	18-8860	—	—
502 MAG MPI	502/V-8	1997	K147350	K999999	18-8863	Ⓜ	—
502 MAG MPI	502/V-8	1998-2001	L017000	M024999	18-8861	Ⓜ	—
600SC	502/V-8	1992-2000	D725676	L601186	18-8860	—	—
8.2L MAG & HO	502/V-8	2010	A340340	& Up	18-8864	Ⓜ	18-8865 Ⓜ
8.2L MAG & HO MIE	502/V-8	2010	A350802	& Up	18-8864	Ⓜ	18-8865 Ⓜ
8.2L MIE	502/V-8	1993-1996	D857200	F819619	18-8860	—	—
8.2L MPI MIE	502/V-8	1996-1997	F819620	K147349	18-8860	—	—
8.2L MPI MIE	502/V-8	1997	K147350	K999999	18-8863	Ⓜ	—
8.2L MPI MIE	502/V-8	1998-2001	L002450	L674200	18-8861	Ⓜ	—

- Ⓜ low pressure lift pump
- Ⓜ high pressure fuel cool pump
- Ⓜ fuel pump mounted with filter bowl facing up
- Ⓜ fuel pump mounted with filter bowl facing down
- Ⓜ AC fuel pump
- Ⓜ Carter fuel pump
- Ⓜ mechanical fuel pump
- Ⓜ use if fuel pump has sight glass
- Ⓜ use if fuel pump has sight tube
- Ⓜ fuel pump/cooler kit

FUEL WATER SEPARATORS

Sierra fuel water separators remove over 99.8% of emulsified water from your gasoline. Sierra's 10 micron filters are over 90% efficient at removing particles as small as 10 micron. All filters flow @ 90 GPH to feed even the hungriest motor. Sierra 10 micron filters are recommended to prevent damage to sensitive inboard and outboard fuel injection systems.

- UNIVERSAL DESIGN -
**DIRECT REPLACEMENT FOR MERCURY AND YAMAHA
 FUEL WATER SEPARATOR BRACKETS**



Bracket Type	Part #	Replaces	Bracket Type	Part #	Replaces
1/4" Stainless Steel	18-7777		1/4" Aluminum	18-7853-1	Mercury 89876A3
3/8" Stainless Steel	18-7776		3/8" Aluminum	18-7775	

FUEL WATER SEPARATOR KITS



21 MICRON FILTER KITS - FOR CARBURETED ENGINES

Kit Type	Part #	Micron Rating	Contents	Replaces
1/4" Aluminum (Short Filter)	18-7848-1	21	1 - 18-7844 filter & 1 18-7853-1 bracket 2 - 18-4256 1/4" pipe plugs	Mercury - 35-802893A4, Q4, 35-60494A4
1/4" Aluminum Bonus Pack Contains spare filter	18-7848-2	21	2 - 18-7844 filter & 1 18-7853-1 bracket 2 - 18-4256 1/4" pipe plugs	
1/4" Aluminum (Tall Filter)	18-7852-1	21	1 - 18-7845 filter & 1 18-7853-1 bracket 2 - 18-4256 1/4" pipe plugs	
1/4" Aluminum Bonus Pack Contains spare filter	18-7852-2	21	2 - 18-7845 filter & 1 18-7853-1 bracket 2 - 18-4256 1/4" pipe plugs	
3/8" Aluminum (Tall Filter)	18-7775-1	21	1 - 18-7845 filter & 1 18-7775 bracket 2 - 18-4264 3/8" pipe plugs	
1/4" Stainless Steel (Tall Filter)	18-7777-1	21	1 - 18-7845 filter & 1 18-7777 bracket 2 - 18-4256 1/4" pipe plugs	
3/8" Stainless Steel (Tall Filter)	18-7776-1	21	1 - 18-7845 filter & 1 18-7776 bracket 2 - 18-4264 3/8" pipe plugs	



10 MICRON FILTER KITS FOR FUEL INJECTED ENGINES

Kit Type	Part #	Micron Rating	Contents
1/4" Aluminum (Short Filter)	18-7983-1	10	1 - 18-7944 filter & 1 18-7853-1 bracket 2 - 18-4256 1/4" pipe plugs
1/4" Aluminum Bonus Pack Contains spare filter	18-7983-2	10	2 - 18-7944 filter & 1 18-7853-1 bracket 2 - 18-4256 1/4" pipe plugs
1/4" Aluminum (Tall Filter)	18-7982-1	10	1 - 18-7945 filter & 1 18-7853-1 bracket 2 - 18-4256 1/4" pipe plugs
1/4" Aluminum Bonus Pack Contains spare filter	18-7982-2	10	2 - 18-7945 filter & 1 18-7853-1 bracket 2 - 18-4256 1/4" pipe plugs
1/4" Aluminum (High Capacity Filter)	18-7966-1	10	1 - 18-7866 filter & 1 18-7853-1 bracket 2 - 18-4256 1/4" pipe plugs
3/8" Aluminum (Tall Filter)	18-7986-1	10	1 - 18-7945 filter & 1 18-7775 bracket 2 - 18-4264 3/8" pipe plugs
1/4" Stainless Steel (Tall Filter)	18-7984-1	10	1 - 18-7945 filter & 1 18-7777 bracket 2 - 18-4256 1/4" pipe plugs
3/8" Stainless Steel (Tall Filter)	18-7985-1	10	1 - 18-7945 filter & 1 18-7776 bracket 2 - 18-4264 3/8" pipe plugs



10 MICRON FILTER KITS WITH DRAIN BOWLS

Sierra AquaVue™ and metal bowl separator filters allow water to be drained from the filter to extend service life. Use the AquaVue™ bowl for outboard, above deck installations. USCG regulations require the use of the flame resistant metal bowl below deck.

Kit Type	Part #	Micron Rating	Contents
1/4" Aluminum w/ metal drain bowl	18-7951	10	1 - 18-7919 filter & 1 18-7853-1 bracket 1 - 18-7924 metal bowl 2 - 18-4256 1/4" pipe plugs
1/4" Stainless Steel w/ metal drain bowl	18-7938	10	1 - 18-7919 filter & 1 18-7777 bracket 1 - 18-7924 metal bowl 2 - 18-4256 1/4" pipe plugs

COMPACT BRACKET AND SEPARATOR KIT - FOR SMALL OUTBOARDS AND FRESH WATER APPLICATIONS

18-7774
COMPACT ALUMINUM BRACKET



18-7965-1
10 MICRON COMPACT SEPARATOR KIT
Contains:
1 - 18-7774 bracket
1 - 18-7865 filter



REPLACEMENT FILTERS



UNIVERSAL DESIGN - DIRECT REPLACEMENT FOR MERCURY

10 MICRON REPLACEMENT FILTERS			21 MICRON REPLACEMENT FILTERS		
Part #	Description	Replaces	Part #	Description	Replaces
18-7944	Short - 3.875"	Mercury - 35-807172, 35-802893Q	18-7844	Short - 3.875"	Mercury - 35-807172, 35-802893Q
18-7945	Long - 4.35"	Mercury - 35-802893Q	18-7845	Long - 4.35"	Mercury - 35-802893Q
18-7866	High Capacity - 6"				
18-7865	Compact 10 Micron				



10 Micron replacement filters and kits with drain bowls

REPLACEMENT FILTERS			REPLACEMENT BOWLS	
Part #	Description	Replaces	Part #	Description
18-7919	Spin on replacement	35-809097 Racor S3213	18-7924	Metal Collection Bowl
18-7920	Spin on replacement	Mercury 35-809099 Racor S3214	FILTER & BOWL KITS	
18-7947	Spin on replacement	Racor S3240	Part #	Description
18-7948	Spin on replacement Fits - 320RRAC01	35-886638 Racor S3227	18-7929	Filter & Metal Bowl Mercury Style Contains: 18-7919 filter, 18-7924 bowl
18-7949	Spin on replacement Fits - 660RRAC02	Racor S3232	18-7943	Filter & Metal Bowl Contains: 18-7920 filter, 18-7924 bowl
			18-7969	Filter & Metal bowl Contains: 18-7948 filter, 18-7924 bowl



18-7919
FUEL/WATER SEPARATING FILTER
 Replaces: Mercuriser 35-809097 and Racor™ S3213
 For styles with spin on drain bowls.



18-7784
FUEL FILTER
 Replaces:
 Mercuriser 35-11004A1, 35-803897Q1
 For: 2.5L/3.0L(6229718 & later), All MC224 CID (6218037 & later), All GM 262 CID (A331455 & later) with Carter Fuel Pumps



18-7977
"GEN III COOL FUEL SYSTEM" FUEL FILTER
 Replaces: 35-866171A01
 For: 350 Mag MPI Alpha/Bravo, 350 Mag MPI Horizon Alpha/Bravo, 350 Mag MPI Horizon MIE, 350 Mag MPI MIE, 496 MAG, 496 MAG H.O., 5.0 MPI Alpha/Bravo, 8.1L Inboard, 8.1L Inboard H.O., MX 6.2L MPI Alpha/Bravo, MX 6.2L MPI Horizon Alpha/Bravo, MX 6.2L MPI Horizon MIE, MX 6.2L MPI MIE



18-7964
TRANSMISSION FILTER KIT
 Replaces: 35-815419, 8791014241
 For: Mercuriser V-8 Inboard with Hurth Transmission



18-7855
FUEL FILTER
 Replaces: 1397-2150



18-7717
FILTER ELEMENT
 Replaces: 35-93568
 For: Rochester 2 bbl & 4 bbl Carburetors



18-7859
FUEL FILTER
 Replaces: 35-53336, 3302-9033, 35-53336Q
 For: Most GM Inline 4 & 6 cycle, Ford & Gm V-8's up to 400 HP and all Mercuriser 224 CID



18-7721
FUEL FILTER
 Replaces: 35-864572
 All MPI & EFI engines with boost pump, 8.1L & 496cid, for 3/8" ID fuel lines



18-7860
FUEL FILTER
 Replaces: 35-49088A2, 35-49088Q2
 (Used in 18-7278 Fuel Pump)
 For: Inline 4 & 6 cycle engines



18-7869
FUEL FILTER
 Replaces:
 1397-8767, 1397-8545
 For:

Model/HP	Serial #	Model/HP	Serial #
GM 2.5L/3.0L	6229718 & later	330 HP	6083145 & later
GM 5.0L/5.7L	6218462 & later	GM 255	590768 & later
All 205	A331455 & later	5.7L SKI 340,230	ALL
228 HP	6021784 & later	& 260 Inboards	



18-7873
FUEL FILTER
 Replaces: 35-808275
 For: Models D7.3/270 Bravo & MIE Diesel Engines 1994-96



18-79901
VST FILTER
 Replaces: 66L-13915-00-00
 Fits: 454 EFI(GenV) GM 1994-96
 454 EFI (SKI)(Gen V) GM 1995
 454 Mag Bravo MPI (Gen VI) GM 1996-97
 454 Mag MPI (SKI)(Gen VI) GM 1996-97
 502 EFI (Gen V) GM 1993-95
 502 Mag MPI (Gen VI) GM 1996
 7.4L MIE MPI (LH) Gen V GM 1995-96
 7.4L MIE MPI (LH) Gen VI GM 1996-97
 7.4LX Bravo MPI (Gen V) GM 1996
 7.4LX Bravo MPI (Gen VI) GM 1996-97
 8.2L MIE MPI (LH) Gen VI GM 1996-97



18-2641
VAPOR SEPARATOR TANK O-RING
 Replaces: 808500



**18-6457
COMPOSITE PULLEY**
Replaces: 807757T
3" OD Serpentine for 13/16"
width belt,
For Late model GM V6 & V8 engines



**18-3506
CIRCULATING PUMP**
Replaces: 46-879194401
For: V6 MCM SN: 1A063240 (2007)
- CURRENT



**18-3593
WATER PUMP**
Replaces: 884727
Late Model 4 cyl GM engines requiring
hose fitting



**18-3574
CIRCULATING WATER PUMP**
Big block GM engines with composite
timing covers
"Late Model" includes 482 and 502 CID
Replaces: 850454, 8504541



**18-3575
CIRCULATING WATER PUMP
(Bi-Directional)**
Replaces: 65142A1
For: GM Inline (4 & 6 Cyl.)



**18-3577
CIRCULATING
WATER PUMP
(Bi-Directional)**
Replaces: 67859, 17670,
811573,8504541
For: Big block GM engines with stamped
steel timing covers



**18-3573
CIRCULATING
WATER PUMP**
All 8.1L big-block GM engines
Replaces: 883925
For engines with composite timing cover



**18-3583
CIRCULATING WATER
PUMP
(Bi-Directional)**
Replaces: 60658, 8503991,
17437
For: GM V-6 & V-8 engines with stamped
steel timing covers.



**18-3584
CIRCULATING WATER PUMP**
Replaces: Mercruiser 71683A1, 883885
Mercruiser 215 to 255 & 888
For: Ford small block V-8 engines.



**18-3599
CIRCULATING WATER PUMP**
Replaces: Mercruiser 811841,
850399, 8503991
For late model GM V-6 & V-8 engines using a composite
timing cover



**18-3007
18-3007-10^①
IMPELLER**
Replaces: 47-89983, 4789983T
For 60 HP



**18-3016-1
IMPELLER KIT**
with gasket
Replaces: 47-862232A2
For: Late-model Bravo & High Performance. Includes
350 Mag., 4.3L., 496 Mag., 5.0L., 8.1S and MX 6.2L



**18-3017
18-3017-10^①
IMPELLER**
Replaces: 47-89984, 47-89984T4,
47-30221, 47-65960
For all #1, R, MR, Alpha Units thru S/N D494568.
Also for raw water pump on: 190 IB S/N 1564539-1720903
225 IB S/N 1539620-2278646



**18-3056
18-3056-10^①
IMPELLER**
Replaces: 47-43026-2
For Alpha I-Generation 2
S/N D494569 & Above
Mercuriser Vazer



**18-3087
IMPELLER**
Replaces: 47-59362, 47-59362T























**18-3109
WATER TUBE GUIDE**
Replaces: 23-29804, 23-29804T
(used with 18-3116 Housing)

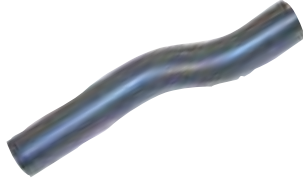

**18-3110
WATER PUMP
HOUSING BUSHING**
Replaces: 26-38970
(Part of 18-3116 Housing)

① Discount shop pack of 10 - Priced per package

 <p>18-3114 INSERT CUP Replaces: 48752, 48752T (Part of 18-3116 Housing)</p>	 <p>18-3117 IMPELLER PLATE Replaces: 32435 For #1 Units thru S/N D494568</p>	 <p>18-3122 IMPELLER PLATE Replaces: 817276, 8172761 For Alpha I - Generation 2 S/N D494569 & Above</p>		
 <p>18-3350 WEAR PLATE Replaces: 94576</p>	 <p>18-3351 WEAR PLATE Replaces: 94916</p>	 <p>18-3293 IMPELLER KEY Replaces: 28-43037</p>		
 <p>18-3151 COUPLING Replaces: 816597</p>	 <p>18-3417 WATER PUMP BASE Replaces: 46-57234A1</p>	 <p>18-3420 WATER PUMP BASE Replaces: 46-44292A3</p>		
 <p>18-3421 WATER PUMP BASE Replaces: 46-48748A1</p>	 <p>18-3116 WATER PUMP HOUSING Replaces: 46-96148A1</p>	<p>PKG. OF 2</p>  <p>18-2732 18-2732-9① WATER SHUTTER Replaces: 807166A3</p>		
 <p>18-2733 WATER SHUTTER Replaces: 99370A2</p>	 <p>18-2727 EXHAUST WATER SHUTTER Replaces: 60930</p>	 <p>18-3220 WATER TUBE Replaces: 32-54236 For #1 -R/MR/Alpha</p>	 <p>18-3221 WATER TUBE Replaces: 32-860220 For Gen II</p>	
 <p>18-3222 WATER TUBE GUIDE Replaces: 23-816583 For Gen II</p>	<p>PKG. OF 5</p>  <p>18-3226 18-3226-9① IMPELLER PUMP SCREW Replaces: 10-30720 For R units</p>	<p>PKG. OF 5</p>  <p>18-3227 18-3227-9① WATER PUMP DOWEL PIN Replaces: 17-35973 For R/MR, Alpha I</p>	<p>PKG. OF 5</p>  <p>18-3229 18-3229-9① WATER POCKET SCREW Replaces: 10-28668 For MR/Alpha</p>	 <p>18-3197 SCREW Replaces: 10-76156</p>

① Priced per Package

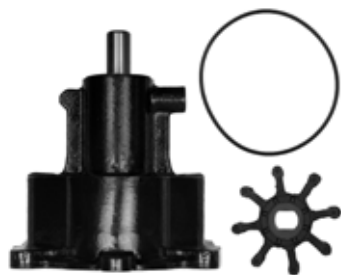

18-3160
SEA WATER PUMP, BRASS
Replaces: 46-862914A13



18-3600
SEA WATER PUMP
Replaces: 46-72774A32
Fits: V8 Engines w/ith V-Belt and 2 piece pump



18-3155
WATER PUMP REPAIR KIT
Replaces: 47-72774A89
Fits: Bravo Seawater Pump with 2 piece housing



18-3216
IMPELLER KIT
Replaces: 47-59362A4
Fits: 1996-97 7.4L MIE MPI(LH) Gen VI GM 454 V8, 1996-97, 7.4L TBI MIE(LH) Gen VI GM 454 V8, 1996-97 8.2L MIE MPI(LH) Gen VI GM 502 V8.



18-3318
WATER PUMP KIT
Replaces: 47-59362Q08
Fits: Plastic 1 and 2 piece sea water pump body



18-3237
IMPELLER REPAIR KIT
For: Bravo I, II, III (1988 & up) B664190 & up Fits Bravo drives with 1 piece housing

—CONTAINS —

Part #	Desc.	O.E. #	Qty.
18-3087	Impeller	47-59362	1
18-3350	Wear Plate	94576	1
18-7163	O-Ring	25-33465	



18-3214
IMPELLER REPAIR KIT
Replaces: 47-43026T6, T8, T11
For Alpha I - Generation II
S/N D494569 & Above
Mercruiser Vazer

① **18-3214D**

—CONTAINS —

Part #	Desc.	O.E. #	Qty.
18-2564	Impeller Gasket	22-43033-1, 27-43033-1	1
18-2565	Impeller Gasket	27-43047-1	1
18-2566	Impeller Gasket	27-817277	1
18-2944	Seal Ring	12-19183	1
18-3056	Impeller	47-43026-1, 47-43026-2	1
18-3122	Impeller Plate	817276	4
18-7420	O-Ring	25-21836	1



18-3217
IMPELLER KIT
For #1 Units thru S/N D494568
(Similar to #46-96148A5 without base or housing)

① **18-3217D**

—CONTAINS —

Part #	Desc.	O.E. #	Qty.
18-3109	Water Tube	23-29804	1
18-3017	Impeller	47-89984	1
18-2919	Water Pump Base to Gear Housing Gasket	27-42631-1	1
18-3110	Grommet	26-38970	1
18-2945	Gear Housing Drain Screw Gasket	12-19183	2
18-2826	Water Pump Base to Gear Housing Gasket	27-85610-1	1
18-2914	Lower Water Pump to Wear Plate Gasket	27-85608-1	1
18-2915	Upper Water Pump to Wear Plate Gasket	27-85609-1	1
18-2944	Seal Ring	26-45577	1
18-3117	Plate	32435	1
18-7158	O-Ring	25-30613	1
18-7162	O-Ring	25-33145	1
18-7173	O-Ring	25-30224	1
18-7176	O-Ring	25-90011	1
18-2801	Water Pump Gasket	27-32438	1
18-7196	O-Ring	25-38099	1
18-7426	O-Ring	35-30271	1



18-3150
WATER PUMP KIT
Replaces: 46-807151A14
For: Bravo



① **18-3309D**
18-3309
WATER PUMP KIT
For: Bravo

—CONTAINS —

Part #	Desc.	O.E. #	Qty.
18-3350	Wear Plate	94576	1
18-3351	Wear Plate	94916	1
18-3087	Impeller	47-59362	1
18-0386	Body Gasket	27-94914	2
18-0916	Water Pump Gasket	27-805215-1	1



18-3147
WATER PUMP KIT
Replaces: 817275T4
For: Gen II-Lower
s/n D469859 and Up

① Items ending in "D" are Display Packaged - Regular number is Non-Display

—CONTAINS —

Part #	Desc.	O.E. #	Qty.
18-3109	Water Tube	23-29804	1
18-3017	Impeller	47-89984	1
18-3116	Housing	46-96148A1	1
18-2919	Water Pump Base to Gear Housing Gasket	27-42631-1	1
18-3110	Grommet	26-38970	1
18-2945	Gear Housing Drain Screw Gasket	26-20260, 12-19183	2
18-2826	Water Pump Base to Gear Housing Gasket	27-85610-1	1
18-2914	Lower Water Pump to Wear Plate Gasket	27-85608-1	1
18-2915	Upper Water Pump to Wear Plate Gasket	27-85609-1	1
18-2944	Seal Ring	26-45577	1
18-3117	Plate	32435	1
18-7158	O-Ring	25-30613	1
18-7162	O-Ring	25-33145	1
18-7173	O-Ring	25-30224	1
18-7176	O-Ring	25-90011	1
18-2801	Water Pump Gasket	27-32438	1
18-7196	O-Ring	25-38099	1
18-7426	O-Ring	35-30271	1

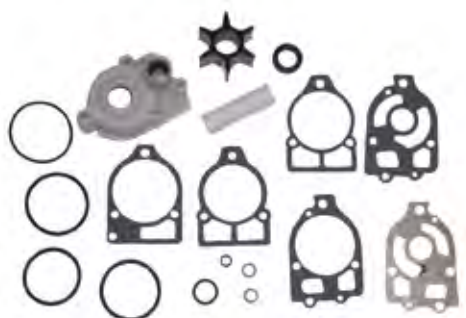

**18-3517
WATER PUMP KIT
Without Base**
Replaces: 46-96148A5, 46-60367A1, 46-96148A8

—CONTAINS —

Part #	Desc.	O.E. #	Qty.
18-3109	Water Tube	23-29804	1
18-3017	Impeller	47-89984	1
18-3116	Housing	46-96148A1	1
18-3420	Water Pump Base	46-44292A3	1
18-2919	Water Pump Base to Gear Housing Gasket	27-42631-1	1
18-3110	Grommet	26-38970	1
18-2945	Gear Housing Drain Screw Gasket	12-19183	2
18-2826	Water Pump Base to Gear Housing Gasket	27-85610-1	1
18-2914	Lower Water Pump to Wear Plate Gasket	27-85608-1	1
18-2915	Upper Water Pump to Wear Plate Gasket	27-85609-1	1
18-2944	Seal Ring	26-45577	1
18-3117	Plate	32435	1
18-7158	O-Ring	25-30613	1
18-7162	O-Ring	25-33145	1
18-7173	O-Ring	25-30224	1
18-7176	O-Ring	25-90011	1
18-2801	Water Pump Gasket	27-32438	1
18-7196	O-Ring	25-38099	1
18-7426	O-Ring	35-30271	1



**18-3320
WATER PUMP KIT**
For: MR/Alpha I Units
S/N 6854393-OD469858

—CONTAINS —

Part #	Desc.	O.E. #	Qty.
18-3109	Water Tube	23-29804	1
18-3017	Impeller	47-89984	1
18-3116	Housing	46-96148A1	1
18-3421	Water Pump Base	46-48748A1	1
18-2919	Water Pump Base to Gear Housing Gasket	27-42631-1	1
18-3110	Grommet	26-38970	1
18-2945	Gear Housing Drain Screw Gasket	12-19183	2
18-2826	Water Pump Base to Gear Housing Gasket	27-85610-1	1
18-2914	Lower Water Pump to Wear Plate Gasket	27-85608-1	1
18-2915	Upper Water Pump to Wear Plate Gasket	27-85609-1	1
18-2944	Seal Ring	26-45577	1
18-3117	Plate	32435	1
18-7158	O-Ring	25-30613	1
18-7162	O-Ring	25-33145	1
18-7173	O-Ring	25-30224	1
18-7176	O-Ring	25-90011	1
18-2801	Water Pump Gasket	27-32438	1
18-7196	O-Ring	25-38099	1
18-7426	O-Ring	35-30271	1



**18-3321
WATER PUMP KIT**
For: #1 Units with flush
S/N 2495186-2763441

—CONTAINS —

Part #	Desc.	O.E. #	Qty.
18-3109	Water Tube	23-29804	1
18-3017	Impeller	47-89984	1
18-3116	Housing	46-96148A1	1
18-2919	Water Pump Base to Gear Housing Gasket	27-42631-1	1
18-3417	Water Pump Base	46-57234A1	1
18-3110	Grommet	26-38970	1
18-2945	Gear Housing Drain Screw Gasket	12-19183	2
18-2826	Water Pump Base to Gear Housing Gasket	27-85610-1	1
18-2914	Lower Water Pump to Wear Plate Gasket	27-85608-1	1
18-2915	Upper Water Pump to Wear Plate Gasket	27-85609-1	1
18-2944	Seal Ring	26-45577	1
18-3117	Plate	32435	1
18-7158	O-Ring	25-30613	1
18-7162	O-Ring	25-33145	1
18-7173	O-Ring	25-30224	1
18-7176	O-Ring	25-90011	1
18-2801	Water Pump Gasket	27-32438	1
18-7196	O-Ring	25-38099	1
18-7426	O-Ring	35-30271	1
18-2919	Water Pump Gasket	27-46231-1	1



**18-3317
WATER PUMP KIT**
For: #1/R Units without flush
S/N 2763442-6854392

COMPLETE WATER PUMP KIT, IMPELLER REPAIR KIT, IMPELLER APPLICATION

Model	Serial Number	Complete Water Pump Kit	Upper Pump Housing	Upper Pump Kit	Water Pump Base	Impeller Repair Kit	Impeller
#1 Units with plastic flush screw in gear housing	2495186 - 2763441	18-3321	18-3116	18-3517	18-3421	18-3217	18-3017
#1 Units w/o flush screw in gear housing	2763442 - 6854392	18-3317 ①	18-3116	18-3517	18-3417 ①	18-3217	18-3017
MR/ALPHA I	6854393 - OD594568	18-3320	18-3116	18-3517	18-3420	18-3217	18-3017
ALPHA I - Generation II & Vazer	OD494569 & ABOVE	18-3147	--	18-3570	--	18-3214	18-3056
BRAVO/Inboards w/ Plastic pump body	3040411 & ABOVE	--	--	18-3150	--	18-3318	18-3087
BRAVO/Inboards w/ Brass pump body	OM100001 & ABOVE	--	--	18-3160	--	18-3016-1	--

① Models which have been retro-fitted with an Alpha style lower unit (no pre-load pin in top of driveshaft) must use Alpha style parts (18-3320 and 18-3420)

GENERATION II WATER PUMP ASSEMBLY

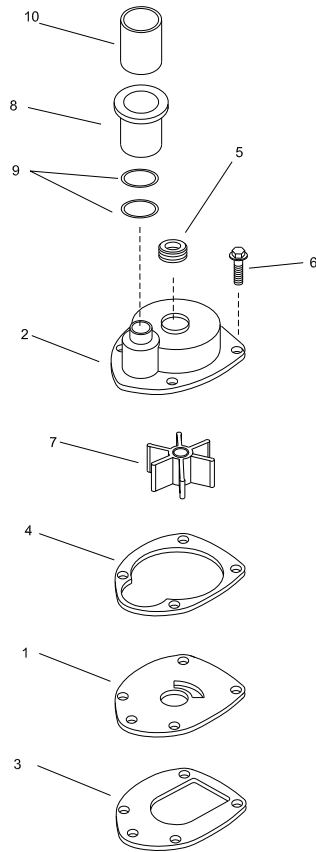

Sequence	Description	Part #	O.E. #	Qty.
1	Face Plate	18-3122	817276	1
2	Housing Assembly	N.S.S.	817275A1	1
3	Gasket, Base	18-2564	27-43033-1	1
4	Gasket, Housing	18-2566	27-817277	1
5	Seal, Face	18-2599	26-816575A2	1
6	Screw, Housing	N/A	10-816928	4
7	Impeller	18-3056	47-43026-2	1
8	Coupling Assembly	18-3151	47-43026T11	1
9	O-Ring	18-7420	25-21836	2
10	Sleeve	18-3222	23-816583	1

MR ALPHA WATER PUMP ASSEMBLY

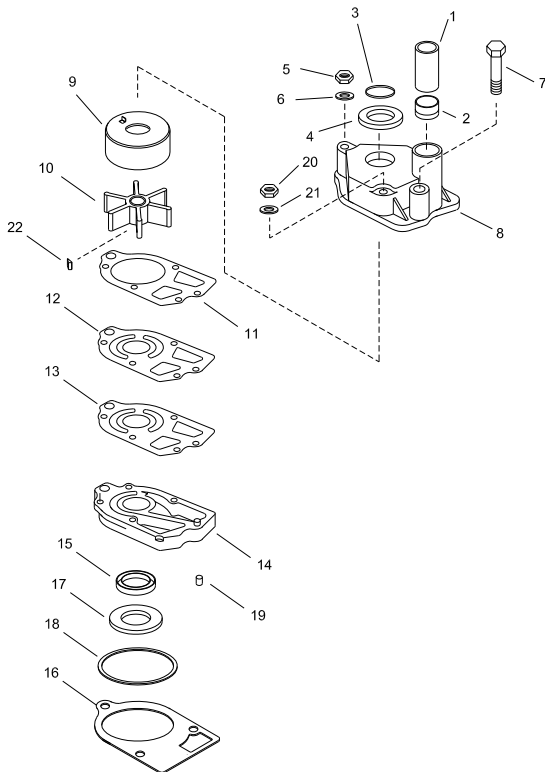

Sequence	Description	Part #	O.E. #	Qty.
1	Guide Sleeve	18-3109	23-29804	1
2	Seal, Sleeve Guide	18-3110	26-38970	1
3	Ring, Upper	18-7158	25-30613	1
4	Ring, Dust	18-7426	25-30271	1
5	Nut, Housing	N/A	11-13436	1
6	Washer, Housing	18-4270	12-36001	3
7	Screw, Housing	N/A	10-96411	1
8	Housing, Water Pump	18-3116	46-96148A1	1
9	Cup, Impeller	18-3114	48752T	1
10	Impeller	18-3017	48752	1
11	Gasket, Impeller	18-2915	47-89984	1
12	Plate, Impeller	18-3117	27-85609-1	1
13	Gasket, Stainless Steel Plate	18-2914	27-85608-1	1
14	Water Pump Base Assembly	18-3420	46-44292A3	1
15	Oil Seal, Water Pump Base	18-2013	26-16977	1
16	Gasket, Water Pump Base	18-2919	27-42631-1	1
17	Oil Seal, Water Pump Base	18-2014	26-89238	1
18	O-Ring, Water Pump Base	18-7176	25-90011	1
19	Pin, Alignment	N/A	17-42836	1
20	Nut, Housing	N/A	11-13438	1
21	Washer, Housing	18-4275	12-29245	2
22	Key, Impeller	N/A	28-56654	1

R WATER PUMP ASSEMBLY

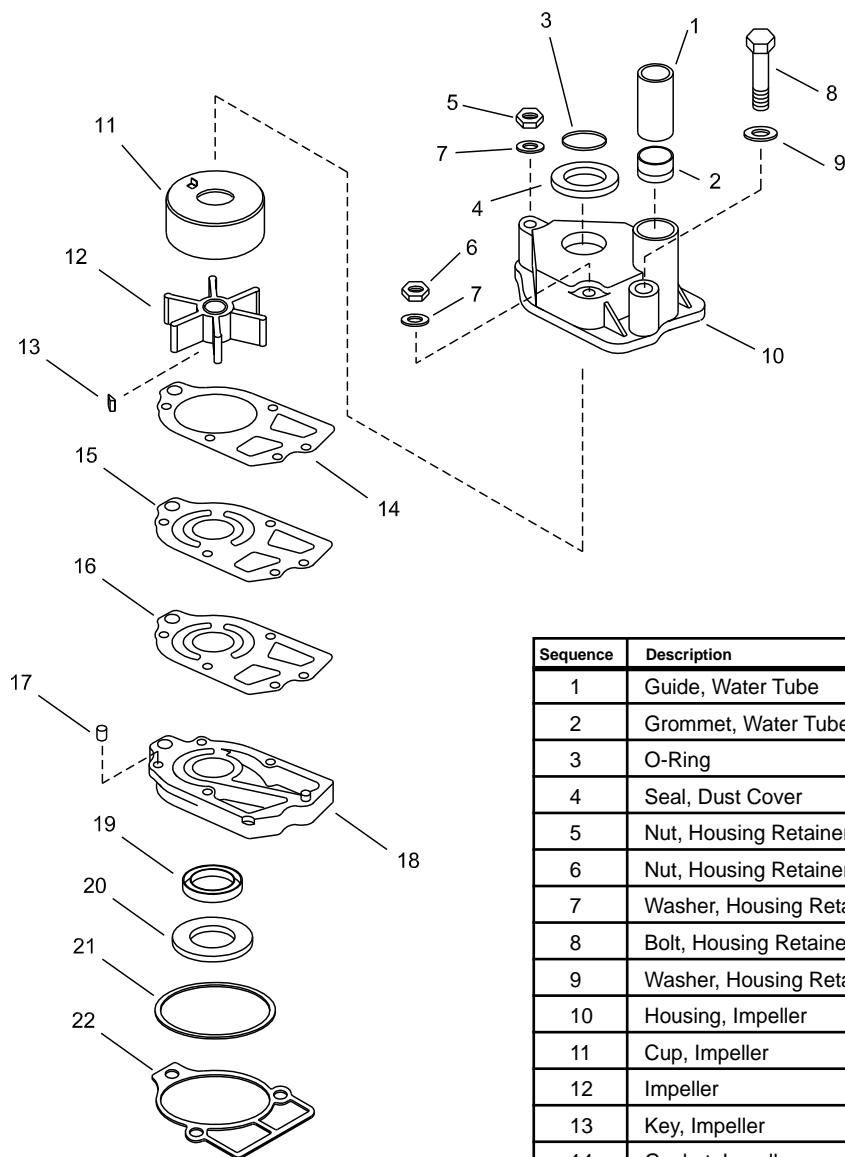

Sequence	Description	Part #	O.E. #	Qty.
1	Guide, Water Tube	18-3109	23-29804	1
2	Grommet, Water Tube Guide	18-3110	26-38970	1
3	O-Ring	18-7158	25-30613	1
4	Seal, Dust Cover	18-7426	25-30271	1
5	Nut, Housing Retainer	18-3723	11-45592	1
6	Nut, Housing Retainer	18-372211-20361, 11-35888		2
7	Washer, Housing Retainer	18-4275	12-29245	3
8	Bolt, Housing Retainer	18-3226	10-30720	1
9	Washer, Housing Retainer	18-4270	12-36001	1
10	Housing, Impeller	18-3116	46-96148A1	1
11	Cup, Impeller	18-3114	48752	1
12	Impeller	18-3017	47-89984	1
13	Key, Impeller	N/A	28-56654	1
14	Gasket, Impeller	18-2915	27-85609-1	1
15	Wear Plate, Impeller	18-3117	32435	1
16	Gasket Wear Plate	18-2914	27-85608-1	1
17	Pin, Alignment	18-3227	17-35973	1
18	Base Assembly	18-3417	46-57234A1	1
19	Oil Seal, Base Assembly	18-2013	26-16977	1
20	Oil Seal, Base Assembly	18-2014	26-89238	1
21	O-Ring, Base Assembly	18-7162	25-33145	1
22	Gasket, Base Assembly	18-2826	27-85610-1	1



**18-3549
THERMOSTAT**
Replaces: 14586
120°



**18-3550
THERMOSTAT**
Replaces: 59078
140°



**18-3551
THERMOSTAT**
Replaces: 59137,
807252T1
142°



**18-3552
THERMOSTAT**
Replaces: 76270, 76270T
160°



**18-3555
THERMOSTAT**
Replaces: 99155A1
160°



**18-3557
THERMOSTAT**
Replaces: 47594
143°



**18-3649
THERMOSTAT**
Replaces: 807252-2
160°



**18-3568
THERMOSTAT KIT**
Replaces: 99155T1

Model	Year	Serial #
5.7MIE	1998-2001	OL002003 & Up
MX6.2LMPI	2000-2001	OL680003 & Up
454 Horizon MIE	1998-2001	OL002200 & Up
502 Mag. MPI	1998-2001	OL017000 & Up



**18-3644
THERMOSTAT KIT**
—CONTAINS—

Part #	Description	O.E.#
18-3649	Thermostat 160°	807252T2
18-2553	Thermostat Cover Gasket	27-47510
18-2917	Thermostat Cover Gasket	27-53045-1



**18-3646
THERMOSTAT KIT**
Replaces: 807252Q3
—CONTAINS—

Part #	Description	O.E.#
18-3551	Thermostat	59137
18-2917	Thermostat Housing Gasket	27-53045-1, 27-33918
18-2844	Thermostat Cover Gasket	27-48818-1
18-2553	Thermostat Cover Gasket	27-47510
18-2834	Thermostat Cover Gasket	27-60208



**18-3647
THERMOSTAT KIT**
Replaces: 807252Q5
—CONTAINS—

Part #	Description	O.E.#
18-3649	Thermostat	807252-2
18-2844	Thermostat Cover Gasket	27-48818-1
18-2552	Thermostat Cover Gasket	27-33179-2
18-2553	Thermostat Cover Gasket	27-47510
18-7173	O-Ring	25-30224
18-2917	Thermostat Housing Gasket	27-53045-1, 27-33918



**18-3648
THERMOSTAT KIT**
160°



**18-3650
THERMOSTAT KIT**
—CONTAINS—

Part #	Description	O.E.#
18-2831	Thermostat Gasket	27-47590-1
18-3550	Thermostat	59078



**18-3651
THERMOSTAT KIT**
—CONTAINS—

Part #	Description	O.E.#
18-2554	Thermostat Cover Gasket	27-90556
18-2553	Thermostat Cover Gasket	27-47510
18-2834	Thermostat Cover Gasket	27-60208
18-2844	Thermostat Cover Gasket	27-48818-1
18-3551	Thermostat	59137



**18-3652
THERMOSTAT KIT**
—CONTAINS—

Part #	Description	O.E.#
18-2555	Thermostat Cover Gasket	27-89656-1
18-2843	Thermostat Cover Gasket	27-74830
18-3552	Thermostat	76270



**18-3667
THERMOSTAT KIT**
—CONTAINS—

Part #	Description	O.E.#
18-2555	Thermostat Cover Gasket	27-89656-1
18-3555	Thermostat	99155A1



**18-3668
THERMOSTAT KIT**
Replaces: 807252T4, 807252Q4
—CONTAINS—

Part #	Description	O.E.#
18-2552	Thermostat Cover Gasket	27-33179-2
18-2553	Thermostat Cover Gasket	27-47510
18-2554	Thermostat Cover Gasket	27-41812
18-3551	Thermostat	59137
18-7173	O-Ring	25-30224
18-2917	Thermostat Housing Gasket	27-53045-1, 27-33918



**18-1977-1
THERMOSTAT HOUSING**
Replaces: 47441A1
Fits 225, GM 260, 228, 898/198,
185R, 898R, 228R, 2GR

THERMOSTAT APPLICATION BEGINS ON NEXT PAGE

① Items ending in "D" are Display Packaged - Regular number is Non-Display



**18-1989
THERMOSTAT HOUSING**
Replaces: 87290A4, 861006A1
Stainless Steel
Use 18-1989K Thermostat Service Kit for replacement parts



**18-1993
THERMOSTAT HOUSING**
Replaces: 78984A01, 861493A3



**18-1994
THERMOSTAT HOUSING**
Replaces: 87290A4
For: Stainless Steel Version use 18-1989



**18-3530-1
THERMOSTAT HOUSING**
Replaces: 860256A4
For: GM V6 and V8 (305 & 350 ci)



**18-3531
THERMOSTAT HOUSING**
Replaces: 861188A1
Fits: MCM/MIE GM V-6 & V-8 305,350,454 & 502 cid engines with closed cooling systems



**18-3532
THERMOSTAT HOUSING AND COVER**
Replaces: 55131A5
Fits: MCM/MIE GM V6 & V8, 305, 350, 454, and 502cid, engines with closed cooling



**18-1910
THERMOSTAT HOUSING KIT**
Replaces: 861493A07
Fits: 3.0L GM 1999-Up, S/N 0L340999-Lower



**18-1989K
THERMOSTAT SERVICE KIT**
Service Kit for 18-1989 Thermostat Housing

THERMOSTAT APPLICATION

Engine / Model	CID / # CYL	Year Range	Beginning Serial #	Ending Serial #	Housing	Thermostat Cover	Thermostat & Gasket Kit	Thermostat	Gaskets Required	Gaskets Required - Design II	Gaskets Required - Design III
ROVER			3140000	UP	—			18-3551	—		
60	68/L4	1965-1968	1887079	2049044				18-3551			
80	80/L4	1966-1969	2049045	2851423				18-3551			
90	96/L4	1970-1972	2851424	3226957				18-3557	18-2831		
100 VASER	98/L4	2007-2010	w995000	& UP					18-1508		
110	153/L4	1963-1966	1537370	2044033		④		18-3551			
110	153/L4	1963-1966	1821720	2044033		⑥		18-3551			
120	153/L4	1964-1972	1666601	3377340		④		18-3551			
120	153/L4	1964-1966	1725593	2046624		⑥		18-3551			
120	153/L4	1967	2046625	2324346		⑥		18-3551			
120	153/L4	1968-1972	2324347	3377340	18-3650	⑥, ③	18-3650	18-3550	18-2831		
120	153/L4	1972-1986	3377341	B531853	18-3650	③	18-3650	18-3550	18-2831		
2.5L	153/L4	1987-1989	B531854	C853255	18-3650	③	18-3650	18-3550	18-2831		
140	181/L4	1968-1986	2508261	B450800	18-3650	③	18-3650	18-3550	18-2831		
140 (6 CYL)			1538930	1725960	—			18-3551			
3.0L	181/L4	1987-1989	B450801	C856558	18-3650	③	18-3650	18-3550	18-2831		
3.0L, FWC	181/L4	1990-2010	C856559	UP		⑥		18-3647	18-3649		
3.0L	181/L4	1990-1994	C856559	F603999	18-3650	⑦, ③		18-3650	18-3550	18-2831	
3.0L	181/L4	2000-2010	L341000	& UP		⑦		18-3647	18-3649	18-2552	
3.0L	181/L4	1998-2000	L010042	L340999	18-3650	⑦, ③		18-3650	18-3550	18-2831	
3.0L MPI	181/L4	2008-2010	A072812	& UP		⑥		18-3647	18-3649	18-2552	
3.0L MPI FWC	181/L4	2008-2010	A072812	& UP		⑥		18-3647	18-3649		
3.0LX, FWC	181/L4	1990-1997	C856559	K999999		⑥		18-3647	18-3649		
3.0LX	181/L4	1990-1997	C856559	K999999	18-1910	⑦, ③	18-3650	18-3550	18-2831		
150			1666495	2048046	—			18-3551			
160			2048022	2770031	—			18-3551			
160			2048022	2233574	—			18-3557			
160			2326069	2770031	—			18-3557	18-2831		
165			2770032	5813433	—			18-3650	18-3550	18-2831	
165	224/L4	1987	B434941	B774251	—			18-3667	18-3555	18-2555	
165			6916779	UP	—			18-3667	18-3555	18-2555	

- ① Design I
- ② Design II
- ③ Design III
- ④ Aluminum Exhaust Manifold
- ⑤ Cast Iron Exhaust Manifold
- ⑥ Closed Cooling
- ⑦ Standard Cooling
- ⑧ With check ball
- ⑨ Without check ball
- ⑩ SN 4167000 & Up
- ⑪ Original thermostat housing listed as NLA. Order update kit 87290A23
- ⑫ Original thermostat housing listed as NLA. Order update kit 90736A24
- ⑬ Complete thermostat housing kit kit
- ⑭ Single and 3-point drain system
- ⑮ 7-point drain system
- ⑯ Mechanical Throttle Body
- ⑰ Digital Throttle Body
- ⑱ Emission Control Engine
- ⑲ Manual drain system
- ⑳ Air Actuated drain system
- Ⓐ Old Design
- ♣ New Design
- ♣ 160 degree
- ♣ For Stainless Steel version use 18-1989

**18-70944
MOLDED HOSE**

Replaces: 32-861590A05

Fits: 4.3L Alpha/Bravo Carb(2002 & Up), 350 Black Scorpion Ski (Gen+) (1997-01), 6.2L Black Scorpion Ski (Gen+) (2001-02), Black Scorpion 350 Mag MPI(2002), Black Scorpion MX 6.2L MPI (2002)



**18-70948
MOLDED HOSE**

Replaces: 32-808033

Fits: 262 Mag EFI Bravo w/Fuel Cool System (1996-97), 4.3L EFI (TBI) (1998-01), 5.0L (Gen+) Bravo (1998-07), 5.0L EFI (Gen+) (1998-01), 350 Mag Alpha (Gen+) (1997), 350 Mag Alpha EFI (Gen+) (1997), 350 Mag Bravo MPI (Gen+) (1997), 350 Mag MPI (Gen+) (1998-01), 5.7L (1997), 5.7L (Gen+) (1998-07), 5.7L EFI (1997), 5.7L EFI (Gen+) 1998-2001, 5.7LX (1997), 5.7LX Bravo EFI (Gen+) (1997), 5.7LX EFI (1997)

For: Cooler to thermostat housing



**18-70949
MOLDED HOSE**

Replaces: 32-807407

Fits: 454 Mag MPI (Gen VI) (1996-01), 7.4LX MPI Bravo (Gen VI) (1996-97), 502 Mag MPI (Gen VI) (1996-01) For: Cooler to thermostat housing



**18-70954
MOLDED HOSE**

Replaces: 32-8600891

Fits: 5.0L (Gen+) Bravo (1998-07), 5.0L EFI (Gen+) Alpha & Bravo (1998-01), 350 Mag Alpha (1997), 350 Mag EFI (Gen+) Alpha (1997), 350 Mag EFI (Gen+) Alpha (1997), 350 Mag MPI (Gen+) Bravo (1997-01), 350 Mag MPI (Gen+) Alpha (1998-01), 5.7L Alpha & Bravo (1997), 5.7L (Gen+) Alpha & Bravo (1998-07), 5.7L EFI Bravo (1997-01), 5.7LX Alpha & Bravo (1997), 5.7LX EFI (Gen+) Alpha & Bravo (1997), 6.2L MPI (2000-01) For: oil cooler to oil cooler



**18-70956
MOLDED HOSE**

Replaces: 32-16012

Fits: MC175/205 (1987), 4.3L (1988-92), 4.3L (Gen II) (1992-95), 4.3LX (Gen II) (1992-95) For: Oil cooler to thermostat housing with all four hose connectors cast into the thermostat housing (No "T" connector) Two hoses to manifold and two hoses to elbow.



**18-70955
MOLDED HOSE**

Replaces: 32-16011

Fits: MC200/230 (1987), 5.0L Alpha (1988-95), 5.0LX Alpha (1988-95), MC260 (1987), 350 Mag Alpha (1987-95), 5.7L Alpha & Bravo (1988-95), 454 Mag Bravo (1988-92), 7.4L (GenV) Bravo (1992-96)

For: Oil cooler to thermostat housing with all four hose connectors cast into the thermostat housing (No "T" connector) Two hoses to manifold and two hoses to elbow.



**18-70952
MOLDED HOSE**

Replaces: 32-887952

Fits: 5.0 L Bravo (1988-95), 5.0LX Bravo (1988-95), 350 Mag MPI Bravo (1995), 350 Mag MPI (Gen+) Bravo (1996), 5.7L Bravo (1988-96), 5.7L EFI 1995, 5.7L EFI Bravo (1996), 5.7LX EFI (Gen+) Bravo (1996) For: Seawater pump to oil cooler



**18-70953
MOLDED HOSE**

Replaces: 32-8080441

Fits: 5.0L EFI (Gen+) Bravo (1998-01), 350 Mag MPI (Gen+) (1998-01), 5.7L Bravo (1997), 5.7L (Gen+) Bravo (1998-07), 5.7L EFI Bravo 1997, 5.7L EFI (Gen+) Bravo (1998-01), 5.7LX Bravo (1997), 5.7LX EFI (Gen+) Bravo (1997), 6.2L MPI (2000-01) For: Seawater pump to oil cooler



**18-70951
MOLDED HOSE**

Replaces: 32-860205

Fits: 262 Mag. EFI Bravo (1996-97), 4.3L (Gen+) Bravo (1998-07), 4.3L TBI (Gen+) Bravo (1998-01), 4.3LH (Gen+) Bravo (1998-02), 4.3LX(H) (Gen+) Bravo (1996-97) For: Seawater pump to oil cooler



**18-70945
MOLDED HOSE**

Replaces: 32-862139

Fits: 4.3L (Gen+) (1998-07), 4.3L EFI (Gen+) (1998-01), 4.3LH (Gen+) (1998-02) For: Thermostat housing to port manifold with 2 piece exhaust manifold





**18-70947
MOLDED HOSE**

Replaces: 32-862124
Fits: 4.3L (Gen+) (1998-07) (S/N 0L619000 & UP), 4.3L EFI (Gen+) (2000-01), 4.3LH (Gen+) (2000-02) For: Thermostat housing to starboard manifold with 2 piece exhaust manifold



**18-70946
MOLDED HOSE**

Replaces: 32-8066362
Fits: 262 Mag EFI (Gen+) (1996-97), 4.3L (Gen+) (1998-07) (S/N 0L01004-0L618999), 4.3L EFI (Gen+) (1998-00), 4.3LH (Gen+) 1998-00), 4.3LX (Gen+) (1996-97), 4.3LXH (Gen+) (1996-97)
For: Thermostat housing to starboard manifold with 2 piece exhaust manifold



**18-70950
MOLDED HOSE**

Replaces: 32-807661
Fits: 3.0L (1999-07), 262 Mag EFI Alpha (1996-97), 4.3L (Gen+) Alpha (1998-07), 4.3L EFI (TBI Gen+) Alpha (1998-01), 4.3LH (Gen+) Alpha (1998-02), 4.3LX(H) (Gen+) Alpha (1996-97), 5.0L (Gen+) Alpha (1998-07), 5.0L EFI (Gen+) Alpha (1998-01), 350 Mag. Alpha (1997), 350 Mag. EFI (Gen+) Alpha (1997), 350 Mag. MPI (Gen+) Alpha (1998-01), 5.7L Alpha (1997), 5.7L (Gen+) Alpha (1998-07), 5.7L EFI Alpha (1997), 5.7L EFI (Gen+) Alpha (1998-01), 5.7LX Alpha (1997) For: Transom to oil cooler



**18-70957
MOLDED HOSE**

Replaces: 32-41642A3
Fits: MC185 (1983-86), MC175 (1987), MC205 (1985-87), 4.3L (1988-92), 4.3L (Gen II) & 4.3LX (Gen II) (1992-95) For: Transom to oil cooler



**18-70958
MOLDED HOSE**

Replaces: 32-96246A4
Fits: MC898 (1983-84), MC200 (1985-87), MC228 (1982-84), MC230 (1985-87), 5.0L & 5.0LX Alpha (1988-95), MC260 (1983-87), 300 Tempest MR (1985-86), MC320 EFI (1987-89), 350 MAG Alpha (1986-96), 5.7L Alpha (1988-96), 5.7LX & 5.7LX EFI Alpha (1996), 454 MAG Alpha (1986-88)
For: Transom to oil cooler



**18-70933
MOLDED HOSE**

Replaces: 32-861634
Fits: 3.0L I/L 4 (1999 & Up)



**18-70934
MOLDED HOSE**

Replaces: 32-897181
Fits: 330 (1977-87), 330 MIE (1977-80), 340 MIE W/ BW (1981-87), 370 TRS (1978-87), 400 TRS (1980-86), 420 (1987-89), 425 (1990-92), 425 (Gen V) (1992-93), 440 TRS (1983-86), 450 (Gen V) (1995-96), 454 EFI (Gen V) (1994-96), 454 Mag Alpha (1986-88), 454 Mag Bravo (1988-92), 454 Mag Bravo(Gen V) (1992-97), 454 Mag MPI Bravo(Gen VI) (1996-98), 454 Mag MPI SKI (Gen VI)(1996-97), 460 TRS (1983-86), 465 (1990-92), 465 (Gen V) (1992-94), 500 Gen+ (1999), 500 (Gen V) (1994-96), 500 (Gen VI)(1997-98), 502 EFI (Gen V)(1993-95), 502 Mag Bravo (1990-92), 502 Mag MPI Bravo (Gen VI), 502 Mag Bravo(Gen V)(1992-93), 502 Mag MPI(Gen VI)(1996), 7.4L MIE W/BW (1988-92), 7.4L Bravo (1988-91), 7.4L Bravo(Gen V)(1992-96), 7.4L Bravo (Gen VI)(1996-97), 7.4L MIE (LH)(Gen V)(1992-96), 7.4L MIE (LH)(Gen VI)(1996-97), 7.4L MIE W/Hurth (1989-92), 7.4L MIE MPI (LH)(Gen VI)(1996-97), 7.4L TBI MIE (LH)(Gen VI)(1996-97), 7.4LX Bravo MPI(Gen V)(1996-97), 7.4LX Bravo TBI(Gen VI)(1996-97), 8.2L MIE (Gen V)(1993-96), 8.2L MIE MPI (Gen VI), 8.2



**18-70935
MOLDED HOSE**

Replaces: 32-806856
Fits: 200 2bbl (1987), 230 4bbl (1987), 260 (1987), 350 Mag SKI (1991-96), 350 Mag Alpha (1987-95), 350 Mag Alpha 4bbl (1996), 350 Mag Alpha EFI (Gen+)(1996), 350 Mag Bravo MPI (1995), 350 Mag Bravo MPI (Gen+)(1996), 350 Mag EFI SKI TBI (1994-96), 350 Mag MPI SKI (1995-96), 4.3L (Gen II)(2bbl)(1993-96), 4.3LX (Gen II)(4bbl)(1993-96), 5.0L 2bbl (1988-95), 5.0LX 4bbl (1988-95), 5.7L (1988-95), 5.7L 2bbl (1996), 5.7L Alpha EFI TBI (1995), 5.7L Bravo EFI TBI(1995), 5.7L Competition SKI (1996), 5.7L EFI (2bbl TBI) (1996), 5.7L MIE (1996), 5.7LX 4bbl (1996), 5.7LX Bravo EFI (Gen+)(1996), 5.7LX EFI 4bbl TBI (1996), Black Scorpion(Gen+)(1996) For: Oil cooler to thermostat housing.



**18-70938
MOLDED HOSE**

Replaces: 32-8066351
Fits: 262 Mag with VST (1996-97), 4.3L-LX (1993-96) Design III, 5.0L-LX (1988-95) Design III, 350Mag-EFI-MPI (1987-96), 5.7L-LX 88-96 Design III.
For: Thermostat housing to port exhaust manifold



**18-70939
MOLDED HOSE**

Replaces: 32-8066361
Fits: 4.3L-LX (1993-96) Standard Cooling Design III, 5.0L-LX/5.7L-LX (1988-95) Standard Cooling Design III, 350 Mag (1987-95) Standard Cooling Design III.
For: Thermostat housing to starboard exhaust manifold



18-70940
MOLDED HOSE

Replaces: 32-860144
Fits: 262 Mag with Fuel Cool, 4.3L-LX (1996 & Up) with 1 pc. manifold, 5.0L-EFI (1998 & Up), 350 Mag-MPI 97-01, 5.7L-EFI (1996-97), 6.2L MPI(20 01& Up).
For: Thermostat housing to port exhaust manifold



18-70941
MOLDED HOSE

Replaces: 32-807697
Fits: 262 Mag with 1 piece exhaust, 4.3L (1998 & Up) with 1 piece exhaust, 4.3LX-EFI (1996-01) with 1 piece exhaust, 5.0L (Gen+) (1998& Up), 5.0L EFI (1998-01), 350Mag EFI-MPI 97-01, 5.7L-LX (1997-98).
For: Thermostat housing to starboard exhaust manifold



18-70942
MOLDED HOSE

Replaces: 32-897301
Fits: 7.4L, 454 Mag, 502 Mag. For: Thermostat housing to starboard exhaust manifold



18-70943
MOLDED HOSE

Replaces: 32-897491
Fits: 7.4L, 454 Mag, 502 Mag. For: Thermostat housing to port exhaust manifold



18-3601
GIMBAL HOUSING WATER FEED HOSE

Replaces: 32-32461
Dia. $\frac{5}{8}$ "
Length $13 \frac{7}{8}$ "



18-3602
WATER INTAKE HOSE

Replaces: 32-4172533
 $13 \frac{7}{8}$ " Length - $\frac{3}{4}$ " I.D.
For: MR, Alpha I, Gen II



18-3603
WATER INTAKE HOSE

Replaces: 32-43437



18-70925
MOLDED HOSE

Replaces: 32-160211
For: 4.3L, 5.0L, & 5.7L
For: Thermostat Cover to Port Manifold



18-70926
MOLDED HOSE

Replaces: 32-73796
For: 5.0L & 5.7L
For: Thermostat Cover to Exhaust Elbow



18-70927
MOLDED HOSE

Replaces: 32-73795
For: 5.0L & 5.7L Port
For: Thermostat Housing to Port Manifold



18-70928
MOLDED HOSE
 Replaces: 32-71613
 For: 5.0L & 5.7L
 For: Thermostat Housing to Oil Cooler



18-70929
MOLDED HOSE
 Replaces: 32-73794
 For: 5.0L & 5.7L Starboard
 For: Thermostat Housing to Starboard Manifold



18-70930
MOLDED HOSE
 Replaces: 32-52481
 For: GM Inline 4 & 6 cyl.
 For: Water Distribution Block to End Cap



18-70931
MOLDED HOSE
 Replaces: 32-96879
 For: 2.5L & 3.0L
 For: Distribution Block to Water Pump

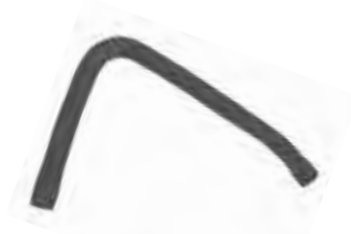

18-70932
MOLDED HOSE
 Replaces: 32-871171
 For: 4.3L, 5.0L, & 5.7L Starboard
 For: Thermostat Cover to Starboard Manifold

SINGLE DIAMETER HOSE



4 3/4"

18-70021
MOLDED HOSE
 3/4" ID



5"

18-70704
MOLDED HOSE
 1 1/4" ID
 For: 3.7L



5"

18-70924
MOLDED HOSE
 1 3/4" ID



12 1/2"

18-71218
MOLDED HOSE
 1" ID
 For: 230 & 260 MIE



12 3/4"

18-71337
MOLDED HOSE
 1 3/4" ID
 For: 4.3L, 5.0L, 5.7L
 Circulating Pump Hose

STRAIGHT HOSE



18-75100
MOLDED HOSE
 Straight 48"
 1" ID



18-75125
MOLDED HOSE
 Straight 48"
 1 1/4" ID

HOSE INTERCHANGE

Part #	Mercruiser Part #	Part #	Mercruiser Part #	Part #	Mercruiser Part #	Part #	Mercruiser Part #
18-70925	32-16021 1	18-70928	32-71613	18-70935	32-806856	18-70704	32-89653
18-3601	32-32461	18-70929	32-73794	18-70941	32-807697	18-70934	32-89718 1
18-71337	32-33189	18-70927	32-73795	18-70940	32-860144	18-70942	32-89730 1
18-3602	32-41725-33	18-70926	32-73796	18-70933	32-861634	18-70943	32-89749 1
18-3603	32-43437	18-70938	32-806635 1	18-71337	32-87108	18-70931	32-96879
18-71218	32-48132	18-70939	32-806636 1	18-70932	32-87117 1		
18-70930	32-52481						

V-BELTS



- 1 High strength synthetic cords resist shockload failure. Their low stretch properties assure uniform performance over the life of the belt.
- 2 The compression section is a special rubber compound that assures smooth and even transfer of load forces to the cords.
- 3 Cogs are molded to precise engineering tolerances to improve flexibility and maintain cord support. Cog geometry provides a large area for air circulation to keep the belt cool and prevent damaging heat build up in the cushion section.
- 4 Rubber edges maintain positive, no-slip contact with pulley grooves for reliable energy transfer.

BELT SIZE LISTING BY NUMBER

Part #	OE #	Effective Length (Inches)	Top Width (Inches)	Part #	OE #	Effective Length (Inches)	Top Width (Inches)
18-15290	57-13457,T	29	29/64	18-15435	57-64416	43 1/2	29/64
18-15300	57-49756	30	29/64	18-15440	57-49213A1,57-45856	44	29/64
18-15325	57-77274A1	32 1/2	29/64	18-15450	-	45	29/64
18-15345	57-74271T	34 1/2	29/64	18-15455	-	45 1/2	29/64
18-15370	57-65607T	37	29/64	18-15460	57-48120A1	46	29/64
18-15380	-	38	29/64	18-15470	57-78200A1	47	29/64
18-15390	57-52692	39	29/64	18-15480	57-48122	48	29/64
18-15400	57-32850,57-69143T	40	29/64	18-15490	57-816295T	52 1/2	29/64
18-15405	57-76269	40 1/2	29/64	18-15495	57-91035A1	49 1/2	29/64
18-15410	57-49043A1,			18-15500	57-96834T,Q	50	29/64
	57-64032A1,57-98043	41	29/64	18-15520	57-33170,Q,57-37619T	52	29/64
18-15415	57-36356	41 1/2	29/64	18-15550	57-13458T	55	29/64
18-15430	57-49211	43	29/64				

SERPENTINE BELTS



BELT INTERCHANGE

Part #	OE #	Width	Length	Part #	OE #	Width	Length
18-15100	57-863876 3	13/16	106.25	18-15114	57-861049	13/16	104.25
18-15101	57-863876 4	13/16	76.5	18-15115	57-861757	13/16	97.5
18-15102	57-863876 6	13/16	105	18-15116	57-861758	13/16	86.75
18-15103	57-863876 7, 57-865615007	13/16	96.75	18-15119	57-863876 1	13/16	111.25
18-15104	57-863876 8	13/16	99.5	18-15121	57-865615005	13/16	87.5
18-15105	57-863876 9, 57-865615009	13/16	69.75	18-15122	57-865615010	13/16	86
18-15112	57-8077554	13/16	88	18-15123	57-864639	13/16	85
				18-15125	57-817113	1-3/8	53.5

BELT APPLICATION

Engine	Years	Serial #	Part #	Mercruiser #	Footnote	Engine	Years	Serial #	Part #	Mercruiser #	Footnote
4.3L Alpha	1996-99	OF803000-OL618999	18-15116	57-861758	2, 6	5.7L Bravo	2002-04	OM600000 & up	18-15102	57-863876 6	3, 5, 7
4.3L Alpha	2000-04	OL619000 & up	18-15101	57-863876 4	3, 6, 7	5.7L Bravo	2000-04	OL619000 & up	18-15104	57-863876 8	4, 7
4.3L Alpha	2000-04	OL619000 & up	18-15104	57-863876 8	4, 5, 7	5.7L Ski	1997-02	OK040004-OM316999	18-15112	57-8077554	
4.3L Alpha	2000-04	OL619000 & up	18-15105	57-865615009	4, 6, 7	5.7L Ski	2002-05	OM317000 & up	18-15121	57-865615005	
4.3L Bravo	1996-99	OF803000-OL618999	18-15114	57-861049	2, 5	5.7L MIE	2001-05	OL677227 & up	18-15121	57-865615005	
4.3L Bravo	1996-99	OF803000-OL618999	18-15115	57-861757	2, 6	377 Scorpion MCM	1999-04	OL416146 & up	18-15115	57-861757	
4.3L Bravo	2000-04	OL619000 & up	18-15104	57-863876 8	4, 7	377 Scorpion Ski	1997-98	OK000656 & up	18-15112	57-8077554	
5.0L Bravo	2002-04	OM600000 & up	18-15102	57-863876 6	3, 5, 7	454 Mag MPI	1998-01	OL010029-OM024999	18-15114	57-861049	1
5.0L Alpha	1998-99	OL012052-OL618999	18-15114	57-861049	5	454 Mag MPI	1998-01	OL010029-OM024999	18-15102	57-863876 6	2
5.0L Alpha	1998-99	OL012052-OL618999	18-15116	57-861758	2, 6	454 Mag MPI	1998-01	OL010029-OM024999	18-15103	57-865615007	4
5.0L Alpha	2000-04	OL619000 & up	18-15101	57-863876 4	3, 6, 7	454 Mag MPI Horizon MIE	1998-01	OL002200-OL674000	18-15103	57-865615007	
5.0L Alpha	2002-04	OM600000 & up	18-15102	57-863876 6	3, 5, 7	496 Mag & HO	2000-04	OM025000 & up	18-15119	57-863876 1	
5.0L Alpha	2001-04	OL619000 & up	18-15104	57-863876 8	4, 5, 7	500 EFI	1999-04	OL001477 & up	18-15112	57-8077554	
5.0L Alpha	2000-04	OL619000 & up	18-15105	57-865615009	4, 6, 7	502 Mag MPI	1998-01	OL017000-OM024999	18-15114	57-861049	1
5.0L Bravo	1998-99	OL012052-OL618999	18-15114	57-861049	2, 5	502 Mag MPI	1998-01	OL017000-OM024999	18-15103	57-865615007	4
5.0L Bravo	1998-99	OL012052-OL618999	18-15115	57-861757	2, 6	502 Mag. MPI	1998-01	OL017000-OM024999	18-15102	57-863876 6	2
5.0L Bravo	2000-04	OL619000 & up	18-15104	57-863876 8	4, 7	525 SC	1991-96	OD456000-745215	18-15125	57-817113	
350 Mag, Alpha	1997-04	OK001501-OL618999	18-15114	57-861049	2, 5	575 Sci	2000-05	OL306696 & up	18-15125	57-817113	8
350 Mag, Alpha	1997-04	OK001501-OL618999	18-15116	57-861758	2, 6	575 Sci	2000-05	OL306696 & up	18-15112	57-8077554	9
350 Mag, Alpha	2000-04	OL619000 & up	18-15103	57-865615007	3, 6, 7	600 SC	1991-96	OD456489-OF877462	18-15125	57-817113	
350 Mag, Alpha	2002-04	OM600000 & up	18-15102	57-863876 6	3, 5, 7	600 SC	1998	OK000227 & up	18-15125	57-817113	
350 Mag, Alpha	2000-04	OL619000 & up	18-15104	57-863876 8	4, 5, 7	7.4L MPI	1998-01	OL010003-OM024330	18-15114	57-861049	1
350 Mag, Alpha	2000-04	OL619000 & up	18-15105	57-865615009	4, 6, 7	7.4L MPI	1998-01	OL010003-OM024330	18-15102	57-863876 6	2
350 Mag, Bravo	1997-04	OK001501-OL618999	18-15114	57-861049	2, 5	7.4L MPI	1998-01	OL010003-OM024330	18-15103	57-865615007	4
350 Mag, Bravo	1997-04	OK001501-OL618999	18-15115	57-861757	2, 6	7.4L MPI MIE	1998-01	OL002006-OM025999	18-15103	57-865615007	
350 Mag, Bravo	2002-04	OM600000 & up	18-15102	57-863876 6	3, 5, 7	Black Scorpion Ski	1997-01	OK040001-OM391599	18-15112	57-8077554	
350 Mag, Bravo	2000-04	OL619000 & up	18-15104	57-863876 8	4, 7	Black Scorpion Ski	2003-05	OM391600 & up	18-15121	57-865615005	
350 Mag MPI MIE	2001-05	OL678399-up	18-15121	57-865615005	6	MX 6.2L Bk Scorpion Ski	2001	OL670015-OM391599	18-15112	57-8077554	
350 Mag MPI MIE	2002-05	OM317000 & up	18-15122	57-865615010	5	MX 6.2L MPI	2002-04	OM600000 & up	18-15102	57-863876 6	3, 5
350 Mag MPI Ski	2001-05	OM300000 & up	18-15121	57-865615005		MX 6.2L MPI	2000-04	OL680003 & up	18-15104	57-863876 8	4, 7
350 Mag MPI Horizon MIE	2001-02	OL678399-OM316999	18-15121	57-865615005		MX 6.2L MPI Horizon	2002-04	OM600000 & up	18-15102	57-863876 6	3
350 Mag MPI Horizon MIE	2001-05	OM317000 & up	18-15122	57-865615010		MX 6.2L MPI Horizon	2001-04	OM300000 & up	18-15104	57-863876 8	4
5.7L Alpha	1997-99	OK001501-OL618999	18-15114	57-861049	2, 5	MX 6.2L MPI Horizon MIE	2001	OM300000-OM310099	18-15112	57-8077554	
5.7L Alpha	1997-99	OK001506-OL618999	18-15116	57-861758	2, 6	MX 6.2L MPI Horizon MIE	2001-05	OM310100 & up	18-15121	57-865615005	6
5.7L Alpha	2000-04	OL619000 & up	18-15101	57-863876 4	3, 6, 7	MX 6.2L MPI Horizon MIE	2002-05	OM317000 & up	18-15122	57-865615010	5
5.7L Alpha	2002-04	OM600000 & up	18-15102	57-863876 6	3, 5, 7	MX 6.2L MPI MIE	1999-01	OL670000-OM310099	18-15112	57-8077554	
5.7L Alpha	2000-04	OL619000 & up	18-15104	57-863876 8	4, 5, 7	MX 6.2L MPI MIE	2001-05	OM310100 & up	18-15121	57-865615005	6
5.7L Alpha	2000-05	OL619000 & up	18-15105	57-865615009	4, 6, 7	MX 6.2L MPI MIE	2002-05	OM317000 & up	18-15122	57-865615010	5
5.7L Bravo	1997-99	OK001506-OL618999	18-15114	57-861049	2, 5	MX 6.2L MPI Ski	2002-05	OM317000 & up	18-15121	57-865615005	
5.7L Bravo	1997-99	OK001506-OL618999	18-15115	57-861757	2, 6	8.2L MPI MIE	1998-01	OL002450-OL674200	18-15103	57-865615007	

Footnote

- 1: Use with plastic 4-3/4" dia. p/s pump pulley
- 2: Use with metal 5-3/4" dia. p/s pump pulley
- 3: For engines with power steering

- 4: For engines without power steering
- 5: For engines with closed cooling
- 6: For engines with standard cooling

- 7: Engines with high mounted alternators
- 8: Blower
- 9: Alternator

Fits GM Big Block V8 454 cu. in. Models 330, 340 & 7.4L

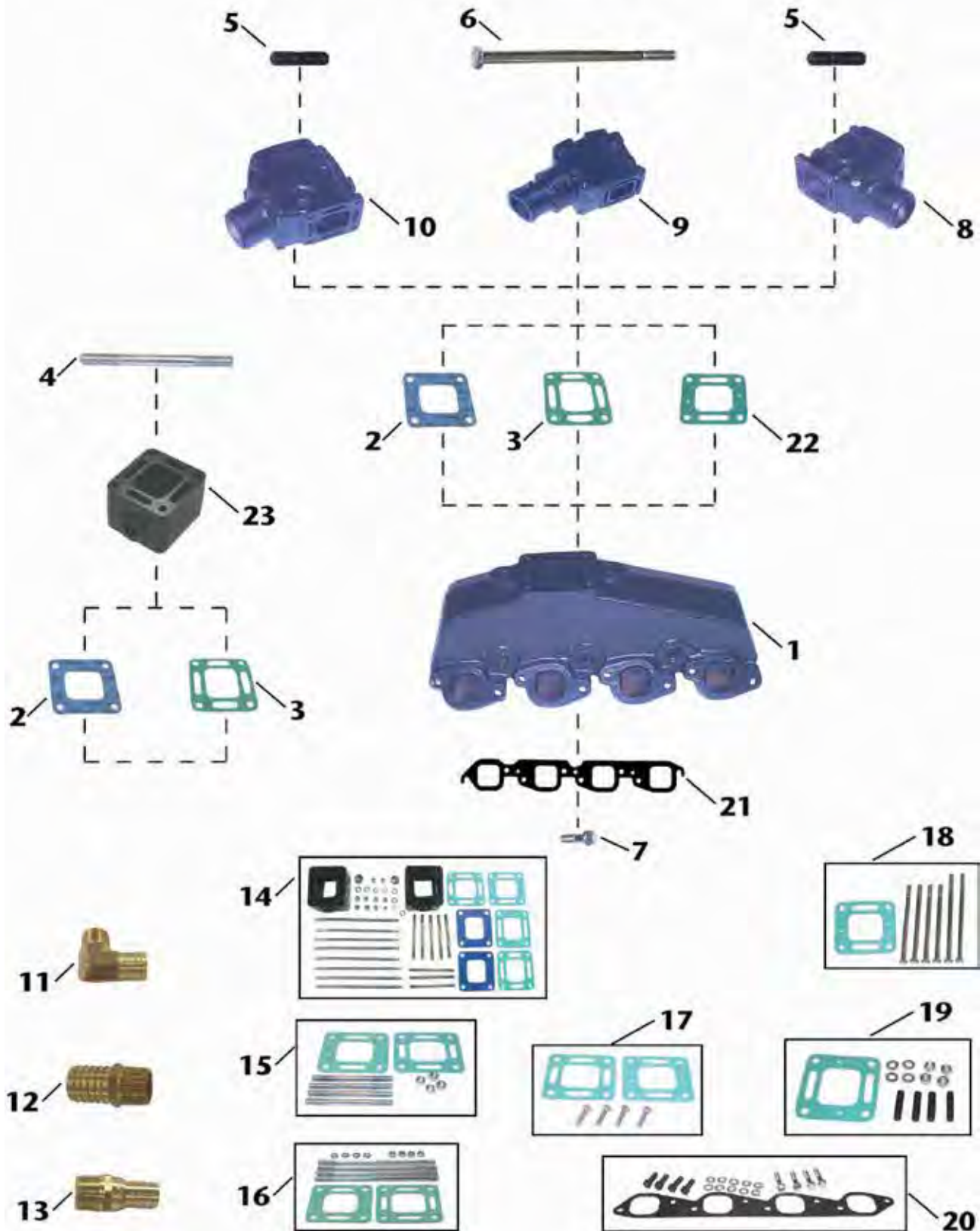

Item No	Description	OE No.	Application
1	18-1957-1 MANIFOLD	807078A6	GM Big Block (V8) 454 cu.in. Models 330, 340 & 7.4L. Use with 18-0418 manifold gasket; Mounting Kit: 18-8532
2	18-0672 (BLOCKED) ELBOW GASKET	27-860231	Fits Manifold: 18-1957-1; Elbows: 18-1970-1, & 18-1976-1, 18-1974: Spacer 18-1908.
3	18-2849 ELBOW GASKET (OPEN)	27-818832	Fits Manifold: 18-1957-1; Elbows: 18-1970-1, & 18-1976-1, 18-1974: Spacer 18-1908.
4	NSS MOUNTING STUD	N/A	Included in 18-8554 mounting kit.
5	NSS MOUNTING STUD	N/A	Included in 18-8529 mounting kit.
6	NSS MOUNTING BOLT	N/A	Included in 18-8505 mounting kit.
7	NSS MOUNTING BOLT	N/A	Included in 18-8532 mounting kit.
8	18-1974-1 MANIFOLD ELBOW	98502A2	Fits Manifold: 18-1957-1. Use Elbow gaskets: 18-2849, 18-0897, or 18-0672; Use mounting kit: 18-8529 (Do not use with spacer)
9	18-1976-1 MANIFOLD ELBOW	44354A3	Fits Manifold: 18-1957-1. Use Elbow gaskets: 18-2849, 18-0897, or 18-0672; Use mounting kit: 18-8505, or if spacer is included use 18-8555
10	18-1970-1 MANIFOLD ELBOW	98504A3	Fits Manifold: 18-1957-1. Use Elbow gaskets: 18-2849, 18-0897, or 18-0672; Use mounting kit: 18-8529, or if spacer is included use 18-8554.
11	18-8216 HOSE FITTING	N/A	3/4" - 14NPT X 1" Hose (Corrosion Resistant Brass Fitting)
12	18-4461 HOSE FITTING	N/A	3/4" - 14NPT X 1" Hose (Corrosion Resistant Brass Fitting)
13	18-8215 HOSE FITTING	N/A	3/4" - 14NPT X 3/4" Hose (Corrosion Resistant Brass Fitting)
14	18-1908K MANIFOLD SPACER KIT	807476A6, 93320A5	3" Riser Kit for Manifold: 18-1957-1. Includes (2) spacers, restrictor, open, & blocked gasket. All necessary mounting hardware is also included.
15	18-8554 MOUNTING KIT	N/A	Use 18-8554 Mounting Kit when 18-1908 Spacer, 18-1970-1 Elbow and 18-1974 Elbow are used together. Included in 18-1908K. Includes (1) 18-2849 & 18-0897 elbow gaskets.
16	18-8555 MOUNTING KIT	N/A	Use with Manifold Spacer: 18-1908 with Riser 18-1976-1. Included in 18-1908K. Includes (1) 18-2849 & 18-0897 elbow gaskets.
17	18-8556 MOUNTING KIT	N/A	Use with Manifold Spacer: 18-1985. Includes (1) 18-2849 & 18-0897 elbow gaskets
18	18-8505 MOUNTING KIT	N/A	Use with Riser: 18-1976-1. Includes 18-0897 elbow gasket.
19	18-8529 MOUNTING KIT	N/A	Use with Risers: 18-1970-1 & 18-1974-1. Includes 18-0897 elbow gasket.
20	18-8532 MOUNTING KIT	N/A	Use with Manifold: 18-1957-1. Includes 18-0418 manifold gasket.
21	18-0418 MANIFOLD GASKET	96653 / 27-46820	Use with Manifold: 18-1957-1. Included in 18-8532 mounting kit.
22	18-0897 ELBOW GASKET (RESTRICTOR)	27-41813	Fits Manifold: 18-1957-1; Manifold Spacers: 18-1985, & 18-1908; Elbows: 18-1970-1, & 18-1976-1, 18-1974
23	18-1908 MANIFOLD SPACER	93322A12	3" Spacer for Manifold: 18-1952-1. Use with mounting kit 18-8556. (Note: To mount elbows to spacer a separate mounting kit is needed)

Fits GM In-Line 6 Cylinder 250 & 292 cu. in. Models 165 & 200

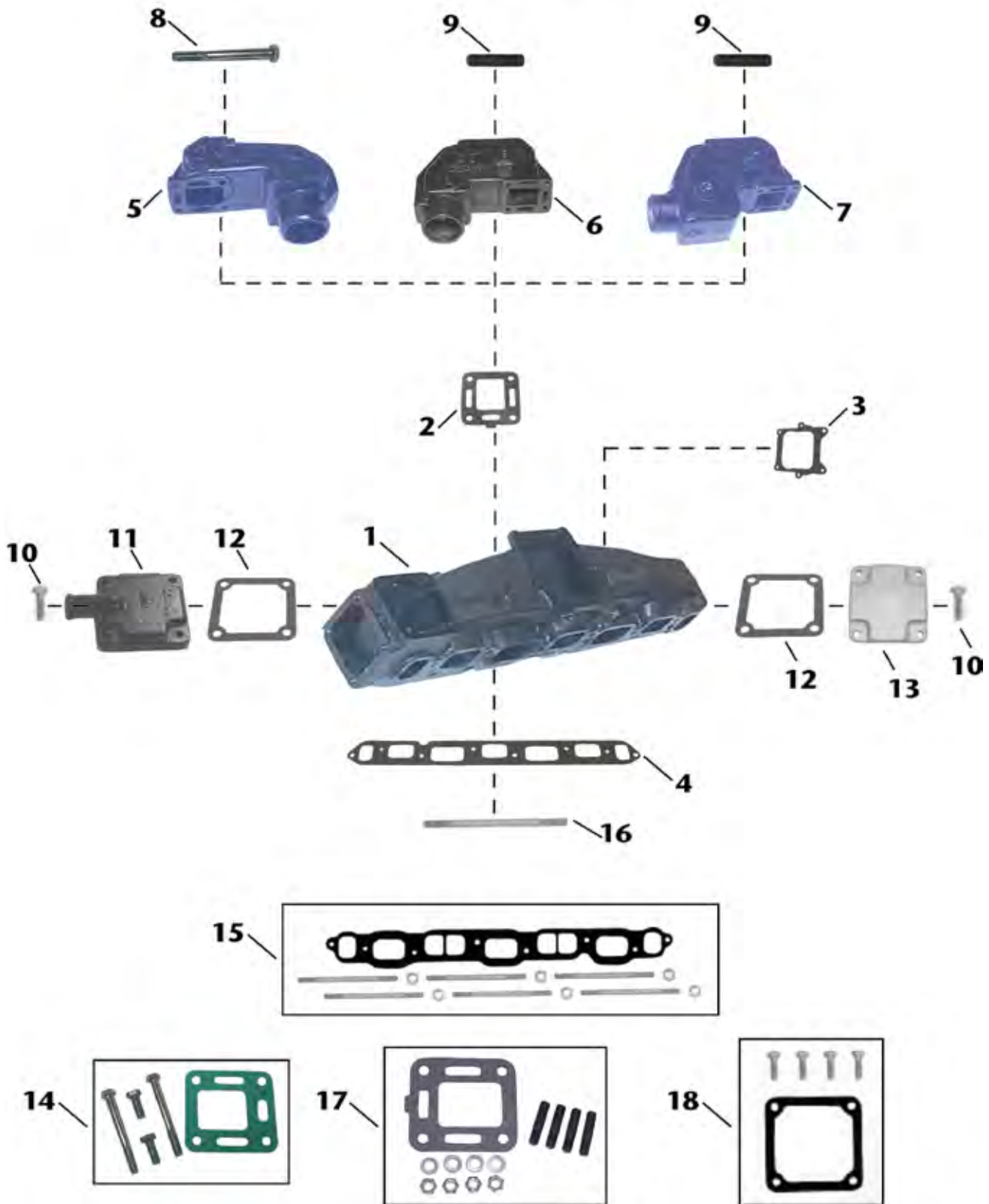

Item No	Description	OE No.	Application
1	18-1960-1 MANIFOLD	58759A10	GM In-Line Six Cylinder 250 & 292 cu.in. Models 165 & 200. Use with 18-2830 manifold gasket; 18-8531 Mounting Kit
2	18-2833 ELBOW GASKET	27-99777-2	Use with Elbows: 18-1971, 18-1978 & 18-1972. Included in 18-4362 mounting kit.
3	18-0353 CARBURETOR GASKET	27-58764	Fits Manifold: 18-1960-1
4	18-2830 MANIFOLD GASKET	27-46401	Fits Manifold: 18-1960-1. Included in 18-8531 mounting kit.
5	18-1972 MANIFOLD ELBOW	76325A2	Use with Manifold: 18-1960-1; Elbow Gasket 18-2833
6	18-1971 MANIFOLD ELBOW	76351A2	Use with Manifold: 18-1960-1; Elbow Gasket 18-2833; Mounting Kit 18-4362.
7	18-1978 MANIFOLD ELBOW	76771A3	Use with Manifold: 18-1960-1; Elbow Gasket 18-2833; Mounting Kit 18-4362.
8	NSS MOUNTING BOLT	N/A	Included in 18-8552 mounting hardware.
9	18-3233 MOUNTING STUD	16-49545	3/8-24, 3/8-16 X 1 3/4. Included in 18-4362 mounting kit.
10	NSS MOUNTING BOLT	N/A	Included in 18-8512 mounting kit.
11	18-4009 FRONT PLATE	60252A2	Fits Manifold: 18-1960-1
12	18-2832 FRONT/END PLATE GASKET	27-48043-1	Fits Port & Starboard Caps of Manifold: 18-1960-1. Included in 18-8512 mounting kit.
13	NSS END PLATE	N/A	Fits Manifold: 18-1960-1
14	18-8552 HARDWARE KIT	N/A	Includes only hardware for 18-1972 elbow.
15	18-8531 MOUNTING KIT	N/A	Use with Manifold: 18-1960-1. Includes 18-2830 manifold gasket.
16	NSS MOUNTING STUD	N/A	Included in 18-8531 mounting kit.
17	18-4362 MOUNTING KIT	N/A	Use with Elbows: 18-1971 & 18-1978. Includes 18-2833 elbow gasket.
18	18-8512 MOUNTING KIT	N/A	Use with Front Plate: 18-4009. Includes 18-2832 gasket.



Fits GM V6 229 & 262 cu. in. Models 185 & 205

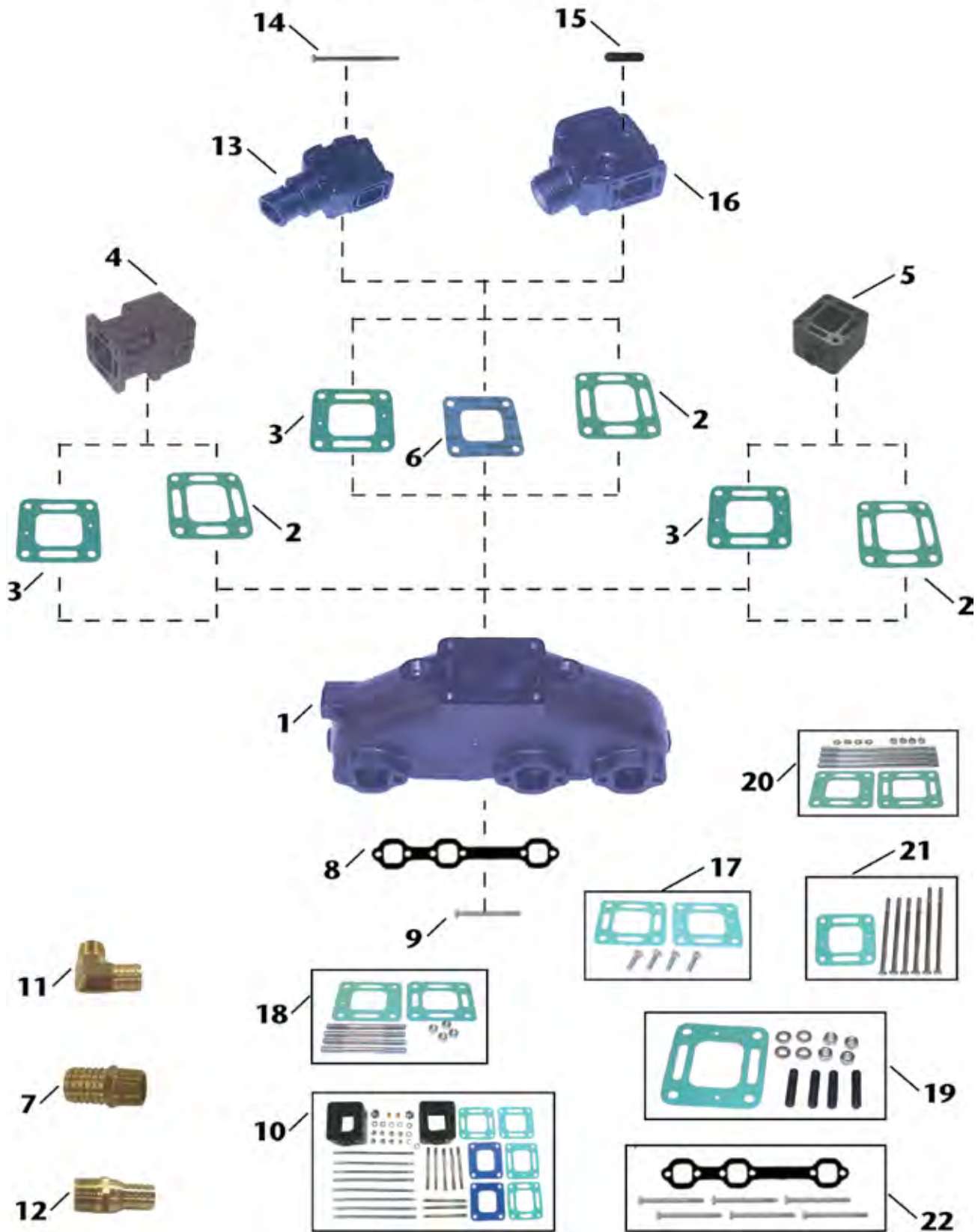

	Item No	Description	OE No.	Application
1	18-1952-1	MANIFOLD	99746A8	GM (V6) 229 & 262 cu.in. Models 185 & 205 (Port & Starboard). Use with Manifold Gasket: 18-2909; Mounting Kit: 18-8533
2	18-2849	ELBOW GASKET (OPEN)	27-818832	Fits Manifold: 18-1952-1; Manifold Spacers: 18-1985, & 18-1908; Elbows: 18-1970-1, & 18-1976-1
3	18-0897	ELBOW GASKET (RESTRICTOR)	27-41813	Fits Manifold: 18-1952-1; Manifold Spacers: 18-1985, & 18-1908; Elbows: 18-1970-1, & 18-1976-1
4	18-1985	MANIFOLD SPACER	93322A12	6" Spacer for Manifold: 18-1952-1. Use with mounting kit 18-8556. (Note: To mount elbows to spacer a separate mounting kit is required)
5	18-1908	MANIFOLD SPACER	933220	3" Spacer for Manifold: 18-1952-1. Use with mounting kit 18-8555 with 18-1976-1, or mounting kit 18-8554 with 18-1970-1.
6	18-0672	ELBOW GASKET (BLOCKED)	27-860231	Fits Manifold: 18-1952-1; Elbows: 18-1970-1, & 18-1976-1
7	18-4461	HOSE FITTING	N/A	3/4" - 14NPT X 1" Hose (Corrosion Resistant Brass Fitting)
8	18-2909	MANIFOLD GASKET	N/A	Gasket for Manifold: 18-1952-1. Included in 18-8533 mounting kit.
9	NSS	MOUNTING BOLT	N/A	Included in 18-8533 mounting kit.
10	18-1908K	MANIFOLD SPACER KIT	807476A6, 93320A5	3" Riser Kit for Manifold: 18-1952-1. Includes (2) spacers, restrictor, open, & blocked gasket. All necessary mounting hardware is also included.
11	18-8216	HOSE FITTING	N/A	3/4" - 14NPT X 1" Hose (Corrosion Resistant Brass Fitting)
12	18-8215	HOSE FITTING	N/A	3/4" - 14NPT X 3/4" Hose (Corrosion Resistant Brass Fitting)
13	18-1976-1	MANIFOLD ELBOW	44354A3, 807914A1	Fits Manifold: 18-1952-1. Use Elbow gaskets: 18-2849. 18-0897, or 18-0672; Use mounting kit: 18-8554
14	NSS	MOUNTING BOLT	N/A	Included in 18-8505 mounting kit.
15	NSS	MOUNTING STUD	N/A	Included in 18-8529 mounting kit.
16	18-1970-1	MANIFOLD ELBOW	98504A3	Fits Manifold: 18-1952-1. Use Elbow gaskets: 18-2849. 18-0897, or 18-0672; Use mounting kit: 18-8529, or if spacer is included use 18-8555.
17	18-8556	MOUNTING KIT	N/A	Use with Manifold Spacer: 18-1985. Includes (1) 18-2849 & 18-0897
18	18-8554	MOUNTING KIT	N/A	Use with Manifold Spacer: 18-1908 with Riser 18-1970-1. Included in 18-1908K. Includes (1) 18-2849 & 18-0897 elbow gaskets.
19	18-8529	MOUNTING KIT	N/A	Use with Riser: 18-1970-1. Includes 18-0897 elbow gaskets.
20	18-8555	MOUNTING KIT	N/A	Use with Manifold Spacer: 18-1908 with Riser 18-1976-1. Included in 18-1908K. Includes (1) 18-2849 & 18-0897 elbow gasket.
21	18-8505	MOUNTING KIT	N/A	Use with Riser: 18-1976-1. Includes 18-0897 elbow gasket.
22	18-8533	MOUNTING KIT	N/A	Use with Manifold: 18-1952-1. Includes 18-2909 manifold gasket.

Fits GM Small Block V8 305-350 cu. in. Models 198, 228 & 898

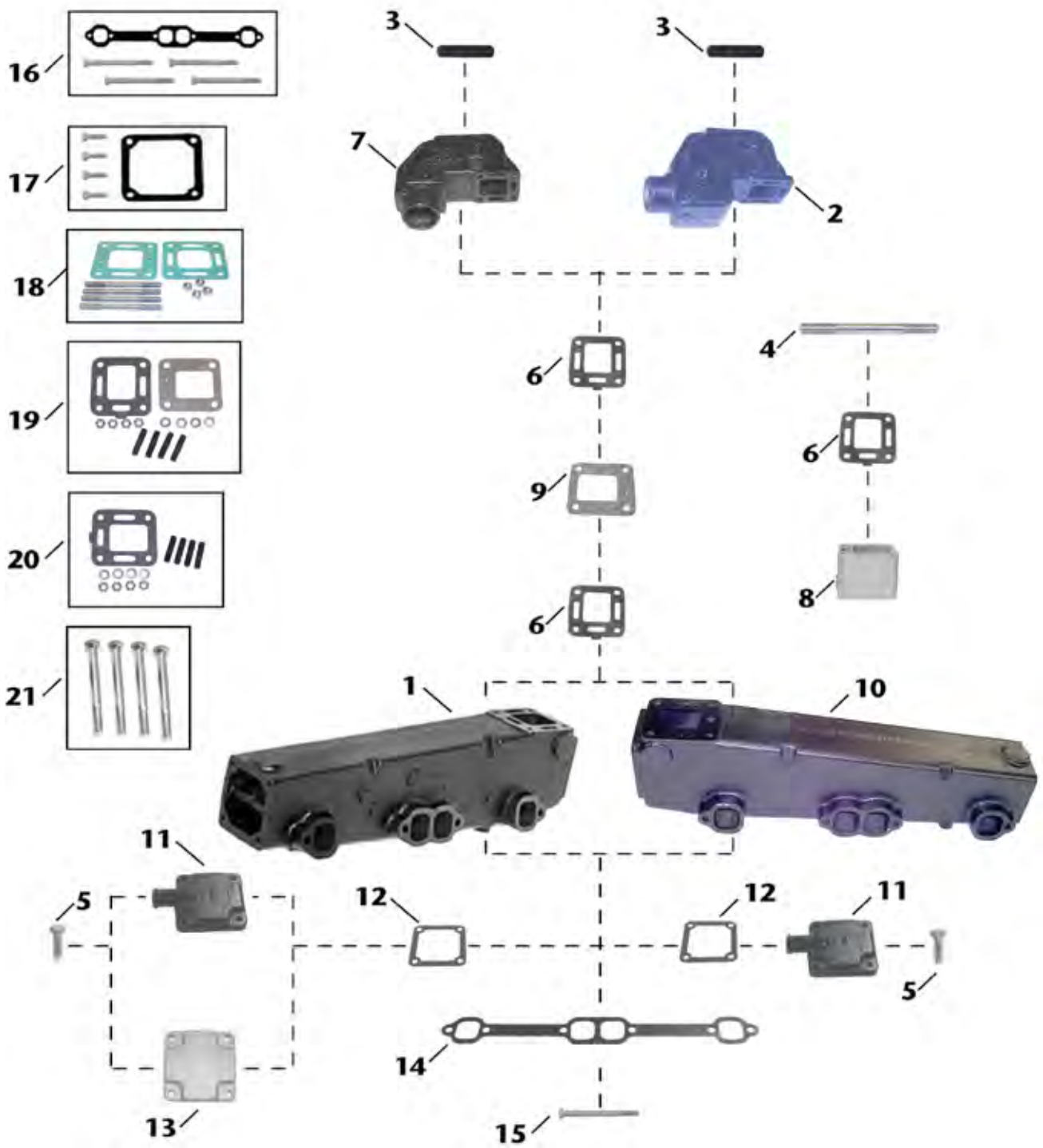

	Item No	Description	OE No.	Application
	1	18-1951-1 MANIFOLD (STARBOARD)	774235A2	GM Small Block (V8) 305-350 cu.in. Models 198, 228, & 898. (Starboard)
	2	18-1978 MANIFOLD ELBOW	76771A3	Use with Manifolds: 18-1950-1, 18-1951-1; Elbow Gasket 18-2833; Mounting Kit 18-4362.
	3	18-3233 MOUNTING STUD	16-49545	3/8-24, 3/8-16 X 1 3/4. Included in 18-4362 mounting kit.
	4	NSS MOUNTING STUD	N/A	Included in 18-8554 mounting kit.
	5	NSS MOUNTING BOLT	N/A	Included in 18-8512 mounting kit.
	6	18-2833 ELBOW GASKET	27-99777-2	Use with Elbows: 18-1971 & 18-1978. Included in 18-4362 mounting kit.
	7	18-1971 MANIFOLD ELBOW	76351A2	Use with Manifolds: 18-1950-1, 18-1951-1; Elbow Gasket 18-2833; Mounting Kit 18-4362.
	8	18-1906 MANIFOLD SPACER	61851	3" Spacer for Manifold: 18-1950-1, 18-1951-1. Use with mounting kit 18-8554 with 18-1971 or 18-1978 Elbows.
	9	18-4008 BLOCK OFF PLATE	60207	Use with Manifolds 18-1950-1, 18-1951-1. Requires (2) 18-2833 elbow gaskets
	10	18-1950-1 MANIFOLD (PORT)	77234A2	GM Small Block (V8) 305-350 cu.in. Models 198, 228, & 898. (Port)
	11	18-4009 END PLATE	60252A2	Use with (Port & Starboard) Manifolds: 18-1950-1 & 18-1951-1; Mounting Kit: 18-8512
	12	18-2832 FRONT/END PLATE GASKET	27-48043-1	Fits Port & Starboard Caps of Manifolds: 18-1950-1, 18-1951-1. Use with Front Plate: 18-4009. Included in 18-8512 mounting kit.
	13	NSS END PLATE	54870	Fits Manifold: 18-1950-1, 18-1951-1; Mounting Kit: 18-8512.
	14	18-2949 MANIFOLD GASKET	96306	Use with Manifold: 18-1951-1
	15	NSS MOUNTING BOLT	N/A	Included in 18-8520 mounting kit.
	16	18-8520 MOUNTING KIT	N/A	Use with Manifolds: 18-1950-1, 18-1951-1. Includes 18-2949 manifold gasket.
	17	18-8512 MOUNTING KIT	N/A	Use with Front/End Plates: 18-4009. Includes 18-2832 front end plate gasket
	18	18-8554 MOUNTING KIT	N/A	Use with Manifold Spacer: 18-1908 with Riser 18-1971 or 18-1978 Elbows. Included in 18-1908K. Includes (1) 18-2849 & 18-0897 elbow gaskets.
	19	18-8514 MOUNTING KIT	N/A	Use with Elbows: 18-1971 & 18-1978. Includes 18-2833 gasket & 18-4008 block off plate.
	20	18-4362 MOUNTING KIT	N/A	Use with Elbows: 18-1971 & 18-1978. Includes 18-2833 elbow gasket.
	21	18-8548 HARDWARE KIT	N/A	Includes only hardware for 18-1950-1 & 18-1951-1 manifolds. Included in 18-8520 mounting kit.

Fits Ford Small Block V8 302-351 cu. in. Models 215, 225, 233, 255 & 888

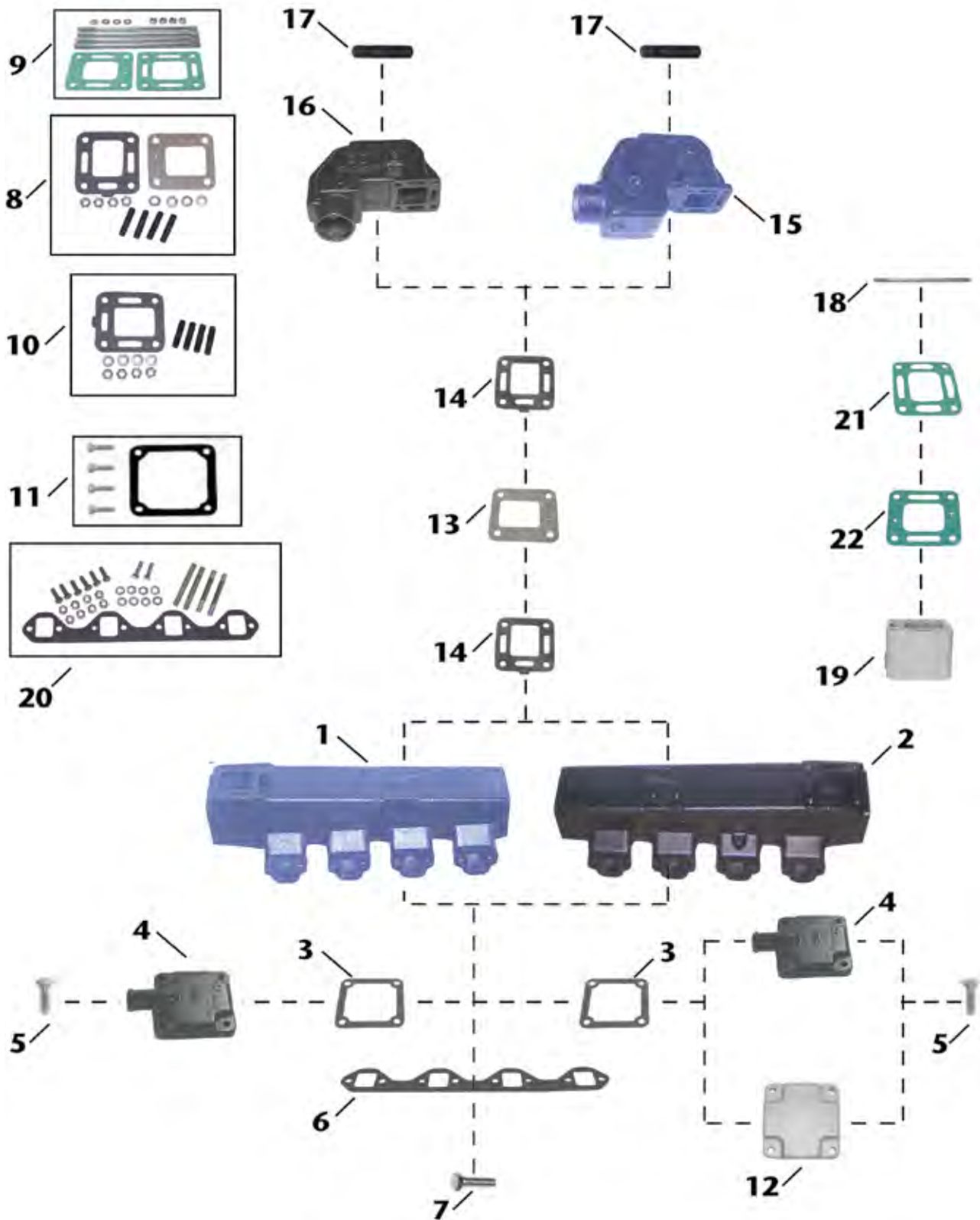

Item No	Description	OE No.	Application	
1	18-1958-1	MANIFOLD (PORT)	65604A4	Ford Small Block (V8) 302-351 cu.in. Models 215, 225, 233, 255, & 888 (Port). Use with Manifold Gasket: 18-0183; Mounting Kit: 18-8509.
2	18-1962-1	MANIFOLD (STARBOARD)	65603A4	Ford Small Block (V8) 302-351 cu.in. Models 215, 225, 233, 255, & 888 (Starboard). Use with Manifold Gasket: 18-0183; Mounting Kit: 18-8509.
3	18-2832	FRONT/END PLATE GASKET	27-48043-1	Fits Port & Starboard Caps of Manifolds: 18-1958-1, 18-1962-1. Use with Front Plate: 18-4009. Included in 18-8512 mounting kit.
4	18-4009	FRONT PLATE	60252A2	Use with (Port & Starboard) Manifolds: 18-1958-1, 18-1962-1; Mounting Kit: 18-8512
5	NSS	MOUNTING BOLT	N/A	Included in 18-8512 mounting kit.
6	18-0183	MANIFOLD GASKET	27-73866	Use with Manifold: 18-1958-1, 18-1962-1. Included in 18-8509 mounting kit.
7	NSS	MOUNTING BOLT	N/A	Included in 18-8509 mounting kit.
8	18-8514	MOUNTING KIT	N/A	Use with Elbows: 18-1971 & 18-1978. Includes 18-2833 gasket & 18-4008 block off plate.
9	18-8554	MOUNTING KIT	N/A	Use with Manifold Spacer: 18-1906 with Riser 18-1971 or 18-1978. Includes (1) 18-2849 & 18-0897 elbow gaskets.
10	18-4362	MOUNTING KIT	N/A	Use with Elbows: 18-1971 & 18-1978. Includes 18-2833 elbow gasket.
11	18-8512	MOUNTING KIT	N/A	Use with Front/End Plates: 18-4009. Includes 18-2832 gasket.
12	NSS	END PLATE	54870	Fits Manifolds: 18-1958-1, 18-1962-1; Mounting Kit: 18-8512.
13	18-4008	BLOCK OFF PLATE	60207	Use with Manifolds 18-1958-1, 18-1962-1. Requires (2) 18-2833 elbow gaskets
14	18-2833	ELBOW GASKET	27-99777-2	Use with Elbows: 18-1971 & 18-1978. Included in 18-4362 mounting kit.
15	18-1978	MANIFOLD ELBOW	76771A3	Use with Manifolds: 18-1958-1, 18-1962-1; Elbow Gasket 18-2833; Mounting Kit 18-4362.
16	18-1971	MANIFOLD ELBOW	76351A2	Use with Manifolds: 18-1958-1, 18-1962-1; Elbow Gasket 18-2833; Mounting Kit 18-4362.
17	18-3233	MOUNTING STUD	16-49545	3/8-24, 3/8-16 X 1 3/4. Included in 18-4362 mounting kit.
18	NSS	MOUNTING STUD	N/A	Included in 18-8554 mounting kit.
19	18-1906	MANIFOLD SPACER	61851	3" Spacer for Manifolds: 18-1950-1, 18-1951-1. Use with mounting kit 18-8554 with 18-1971 or 18-1978 Elbows.
20	18-8509	MOUNTING KIT	N/A	Use with Manifolds: 18-1958-1, 18-1962-1. Includes 18-0183 manifold gasket.
21	18-2849	ELBOW GASKET (OPEN)	27-818832	Fits Manifolds: 18-1958-1, 18-1962-1; Manifold Spacers: 18-1985. Included in 18-8554 mounting kit
22	18-0897	ELBOW GASKET (RESTRICTOR)	27-41813	Fits Manifolds: 18-1958-1, 18-1962-1; Manifold Spacers: 18-1985. Included in 18-8554 mounting kit

Fits GM 4 Cylinder 181 cu. in. Models 120, 140, 2.5L & 3.0L

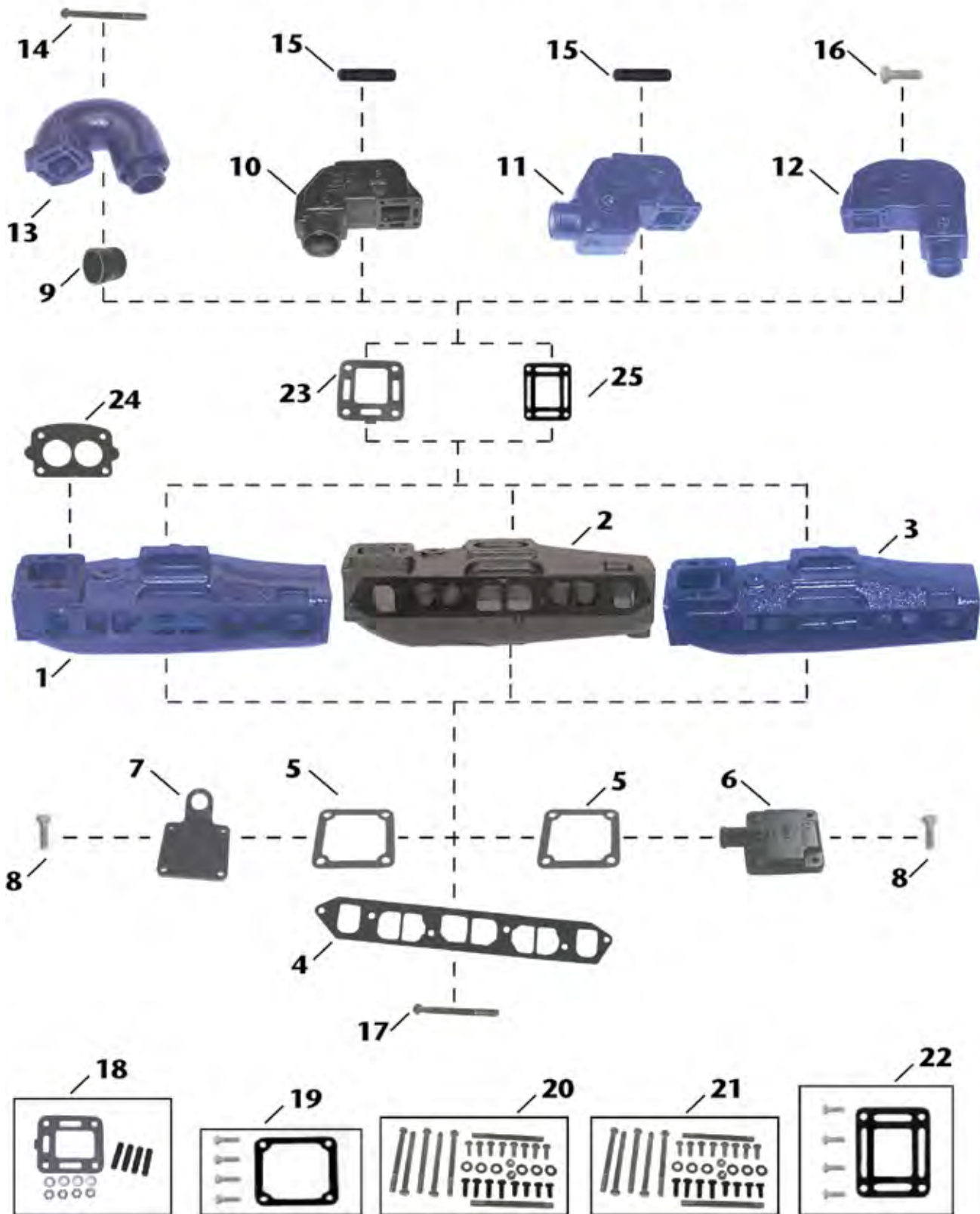

	Item No	Description	OE No.	Application
1	18-1954-1	MANIFOLD	9582A5	Fits 2.5 & 3.0L 181 CID, Model 140 with Rochester carburetor w/ electrical choke (1983-89). Use with Manifold Gasket: 18-1204.
2	18-1955-1	MANIFOLD	96705A1	Fits 3.0L 181 CID, Model 140 with Rochester carburetor w/ mechanical choke (1968-82). Use with Manifold Gasket: 18-1204. Mounting Hardware: 18-8549.
3	18-1956-1	MANIFOLD	99798A18	Fits 3.0L 181 CID, Model 140 & 3.0 with Mercarb carburetor w/ electrical choke (1983-95). Use with Manifold Gasket: 18-1204.
4	18-1204	MANIFOLD GASKET	27-96429	Fits Manifolds: 18-1954-1, 18-1955-1, 18-1956-1
5	18-2832	FRONT/ END CAP GASKET	27-48043-1	Fits Port & Starboard Caps of Manifolds: 18-1954-1, 18-1955-1, 18-1956-1.
6	18-4009	FRONT PLATE	60252A2	Fits Manifolds: 18-1954-1, 18-1955-1, 18-1956-1
7	18-5021	END PLATE	805629	Fits Manifolds: 18-1954-1, 18-1955-1, 18-1956-1
8	NSS	MOUNTING BOLT	N/A	Included in 18-8512 mounting kit.
9	18-2748	EXHAUST BOOT	32-44348T	4" Inside Diameter. Use with 18-1975-1 elbow.
10	18-1971	MANIFOLD ELBOW	76351A2	Use with Manifolds: 18-1954-1, 18-1955-1, 18-1956-1; Elbow Gasket 18-2833; Mounting Kit 18-4362
11	18-1978	MANIFOLD ELBOW	76771A3	Use with Manifolds: 18-1954-1, 18-1955-1, 18-1956-1; Elbow Gasket 18-2833; Mounting Kit 18-4362
12	18-1973	MANIFOLD ELBOW	55538A2	Use with Manifolds: 18-1954-1, 18-1955-1, 18-1956-1; Elbow Gasket 18-2833; Mounting Kit 18-8508
13	18-1975-1	MANIFOLD RISER	12076A2	Use with Manifolds: 18-1954-1, 18-1955-1, 18-1956-1; Elbow Gasket 18-2819; Mounting Hardware 18-8551; Exhaust Boot 18-2748.
14	NSS	MOUNTING BOLT	N/A	Included in 18-8551 mounting hardware.
15	18-3233	MOUNTING STUD	N/A	3/8-24, 3/8-16 X 1 3/4. Included in 18-4362 mounting kit.
16	NSS	MOUNTING BOLT	N/A	Included in 18-8508 mounting kit.
17	NSS	MOUNTING BOLT	N/A	Included in 18-8549 mounting kit.
18	18-4362	MOUNTING KIT	N/A	Use with Elbows: 18-1971 & 18-1978. Includes 18-2833 elbow gasket.
19	18-8512	MOUNTING KIT	N/A	Use with Front Plate: 18-4009 & End Plate (NSS). Includes 18-2832 front/end cap gasket.
20	18-8549	HARDWARE KIT	N/A	Includes only hardware for 18-1955-1 manifold.
21	18-8551	HARDWARE KIT	N/A	Includes only hardware for 18-1975-1 elbow.
22	18-8508	MOUNTING KIT	N/A	Use with Elbow 18-1973. Includes 18-2819 elbow gasket.
23	18-2833	ELBOW GASKET	27-99777-2	Use with Elbows: 18-1971 & 18-1978. Included in 18-4362 mounting kit.
24	18-0356	CARBURETOR GASKET	27-64692	Fits Manifolds: 18-1954-1, 18-1955-1, 18-1956-1
25	18-2819	ELBOW GASKET	27-39915	Use with Elbow: 18-1973. Included in 18-8508 mounting kit.

Fits GM Small Block V8 305 & 350 cu. in. Models 200, 228, 230, 260 & 898

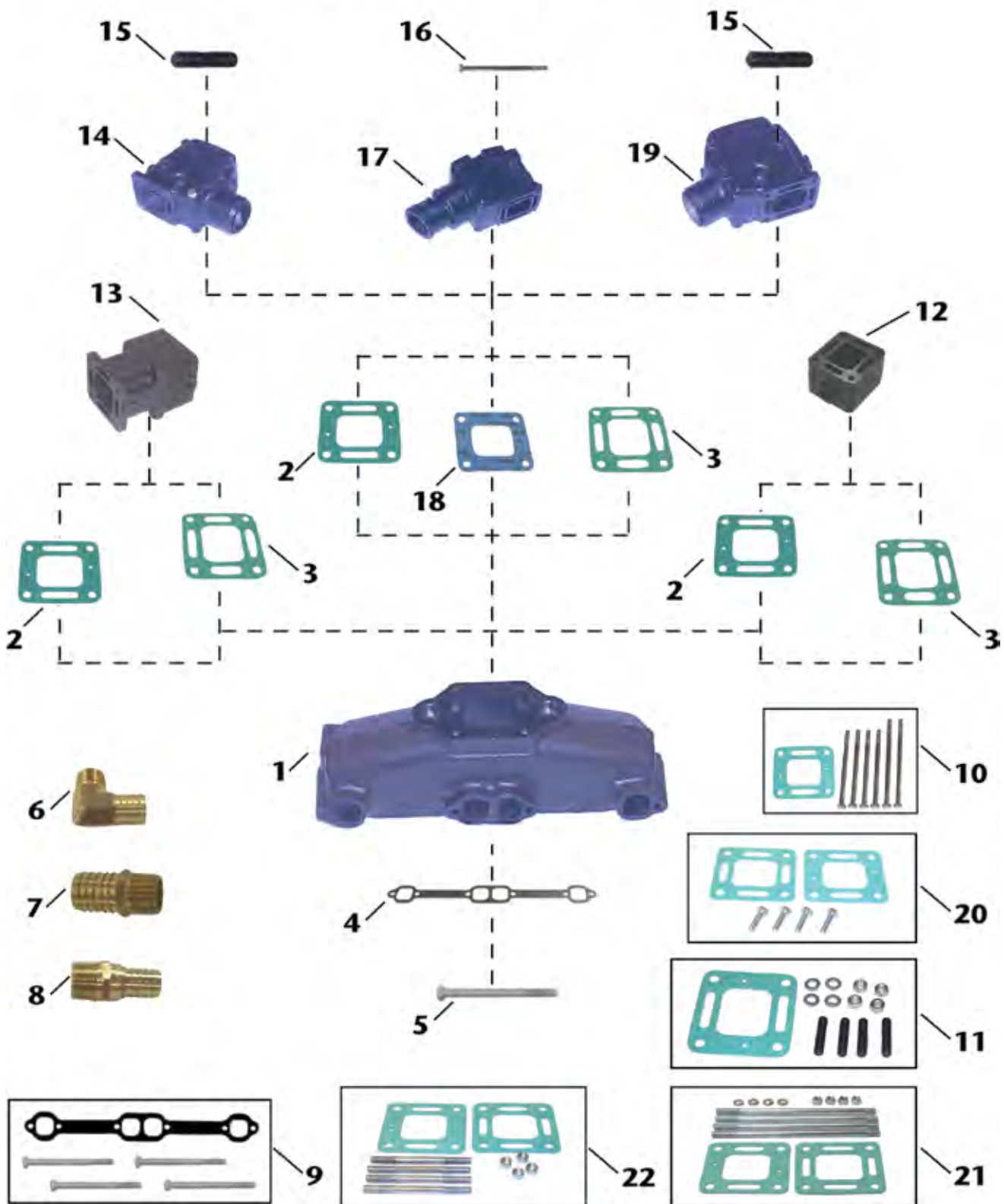

	Item No	Description	OE No.	Application
1	18-1953-2	MANIFOLD	87114A19	GM Small Block (V8) 305-350 cu.in. Models 200, 228, 230, 260, & 898
2	18-0897	ELBOW GASKET (RESTRICTOR)	27-41813	Fits Manifold: 18-1953-2; Manifold Spacers: 18-1985, & 18-1908; Elbows: 18-1970-1, 18-1976-1, 18-1974-1
3	18-2849	ELBOW GASKET (OPEN)	27-818832	Fits Manifold: 18-1953-2; Manifold Spacers: 18-1985, & 18-1908; Elbows: 18-1970-1, 18-1976-1, 18-1974-1
4	18-2949	MANIFOLD GASKET	96306	Use with Manifold: 18-1953-2. Included in 18-8520 mounting kit.
5	NSS	MOUNTING BOLT	N/A	Included in 18-8520 mounting kit.
6	18-8216	HOSE FITTING	N/A	3/4" - 14NPT X 1" Hose (Corrosion Resistant Brass Fitting)
7	18-4461	HOSE FITTING	N/A	3/4" - 14NPT X 1" Hose (Corrosion Resistant Brass Fitting)
8	18-8215	HOSE FITTING	N/A	3/4" - 14NPT X 3/4" Hose (Corrosion Resistant Brass Fitting)
9	18-8520	MOUNTING KIT	N/A	Use with Manifold: 18-1953-2. Includes 18-2949 manifold gasket.
10	18-8505	MOUNTING KIT	N/A	Use with Riser: 18-1976-1. Includes 18-0897 elbow gasket.
11	18-8529	MOUNTING KIT	N/A	Use with Risers: 18-1970-1, 18-1974-1. Includes 18-0897 elbow gaskets.
12	18-1908	MANIFOLD SPACER	933220A12	3" Spacer for Manifold: 18-1953-2. Use with mounting kit 18-8554 with 18-1970-1, or mounting kit 18-8555 with 18-1976-1.
13	18-1985	MANIFOLD SPACER	93322	6" Spacer for Manifold: 18-1953-2. Use with mounting kit 18-8556. (Note to mount elbows to spacer a separate mounting kit is required)
14	18-1974-1	MANIFOLD ELBOW	98502A2	Fits Manifold: 18-1953-2. Use Elbow gasket: 18-2849, 18-0897, or 18-0672; Use mounting kit: 18-8529. (Do not use with spacer)
15	NSS	MOUNTING STUD	N/A	Included in 18-8529 mounting kit.
16	NSS	MOUNTING BOLT	N/A	Included in 18-8505 mounting kit.
17	18-1976-1	MANIFOLD ELBOW	44354A3, 807914A1	Fits Manifold: 18-1953-2. Use Elbow gasket: 18-2849, 18-0897, or 18-0672; Use mounting kit: 18-8505, or if spacer is included use 18-8555.
18	18-0672	ELBOW GASKET (CLOSED)	27-860231	Fits Manifold: 18-1953-2; Manifold Spacers: 18-1985, & 18-1908; Elbows: 18-1970-1, 18-1976-1, 18-1974-1
19	18-1970-1	MANIFOLD ELBOW	98504A3	Fits Manifold: 18-1953-2. Use Elbow gasket: 18-2849, 18-0897, or 18-0672; Use mounting kit: 18-8529, or if spacer is included use 18-8554.
20	18-8556	MOUNTING KIT	N/A	Use with Manifold Spacer: 18-1985. Includes 18-0897 & 18-2849. (Note: To mount elbows to spacer a separate mounting kit is required.)
21	18-8555	MOUNTING KIT	N/A	Use with Riser Kit 18-1908K: Spacer 18-1908: Riser 18-1976-1: Manifold: 18-1952-1
22	18-8554	MOUNTING KIT	N/A	Use with Riser Kit 18-1908K: Spacer 18-1908: Riser 18-1970-1: Manifold: 18-1952-1

SIERRA MANIFOLDS ARE PAINTED, PACKAGED AND LEAK TESTED

**18-1998-1
MANIFOLD**

Port & Starboard
Replaces: Barr FM-1-83
Universal Center Riser Manifold

FITS: Ford 302 and 351 CID engines
Comes with 18-4363 Mounting Package

Use with:
Exhaust Manifold Gasket Set: 18-0603
***For Exploded View - See Pages 560-561**



**18-1997-1
MANIFOLD**

Port & Starboard
Replaces: Barr CHV-1-83 Universal Center Riser Manifold
FITS: GM 283, 305, 307 and 350 CID engines

Use with:
Exhaust Manifold Gasket Set: 18-0604
***For Exploded View - See Pages 558-559**



**18-1898
MANIFOLD**

Port & Starboard
Replaces: Barr CHVA-1-84, Marine Power
0991-110

Fits 454 cu. in. GM big block V8 engines

Use with:
Exhaust Manifold Gasket: 18-0418
Riser: 18-1939, 18-1999
***For Exploded View - See Pages 556-557**



**18-1951-1*
MANIFOLD**

Supplied with Mounting Package
Replaces: 77235A2, 77235A8
STARBOARD SIDE

Fits most Mercruiser (GM) small blocks with end riser

Use with:
Exhaust Manifold Gasket: 18-2949
Mounting Kit: 18-8548

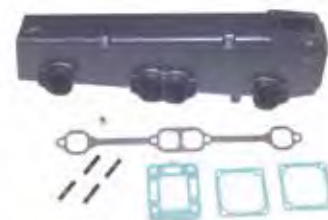

**18-1950-1*
MANIFOLD**

Supplied with Mounting Package
Replaces: 77234A2
PORT SIDE
Fits most Mercruiser (GM) small blocks with end riser

Use with:
Exhaust Manifold Gasket: 18-2949
Mounting Kit: 18-8548



**18-1952-1*
MANIFOLD**

Port & Starboard
Replaces: 99746A8, A17
Fits most 4.3L (262 CID) V-6 application

Supplied with Mounting Package
Use with:
Mounting Kit: 18-8533



**18-1953-2
MANIFOLD**

Port & Starboard
Supplied with Mounting Package
Replaces: 87114A19,86024A10

Will fit either side - Fits most Mercruiser(GM) small blocks with center riser.

Supplied with gaskets
Use with:
Mounting Kit: 18-8520



**18-1954-1*
MANIFOLD**

Supplied with Mounting Package
Replaces: 95862A5
Fits most late Model 2.5L 153 CID & 3.0L 181 CID with Rochester Carb
5 BOLT PATTERN (1983-89)

Use with:
Exhaust Manifold Gasket: 18-1204
End Plate: 18-4009





18-1958-1-1*
MANIFOLD
 Replaces: 65604A4, A12 PORT SIDE ONLY
 Fits most Mercruiser (Ford) V-8 small blocks
 Supplied with Mounting Package
 Use with:
 Mounting Kit: 18-8509

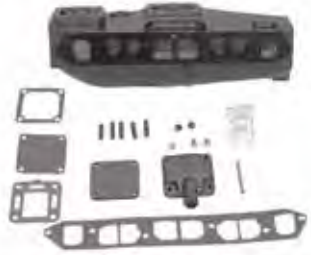

18-1955-1*
MANIFOLD
New Style
 Supplied with Mounting Package
 Replaces: 96705A1
 Fits most early Model 3.0L 181 CID with Rochester Carb. 5 bolt pattern and 2.5L, 153CID (1968-82)
 Use with:
 Exhaust Manifold Gasket: 18-1203
 End Plate: 18-4009



18-1956-1*
MANIFOLD
 Supplied with Mounting Package
 Replaces: 99798A18, 806867A8
 Fits most late Model 2.5L 153 CID and 3.0L 181 CID with MerCarb 5 bolt pattern with electric choke (1983-95)
 Use with:
 Exhaust Manifold Gasket: 18-1204
 End Plate: 18-4009



18-1957-1*
MANIFOLD
 Port & Starboard
 Replaces: 89011A8, 807078A6
 WILL FIT EITHER SIDE
 Fits most Mercruiser (GM) V-8 big blocks with center riser
 Use with:
 Exhaust Manifold Gasket: 18-0418
 Mounting Kit: 18-8532



18-1987-1
MANIFOLD
CONVERSION KIT
 Not for use on engines with high mounted power steering pumps

KIT INCLUDES:
 2 Center rise manifolds
 2 Exhaust elbows
 1 Thermostat housing
 1 Thermostat cover
 1 Thermostat
 All hoses, hardware, gaskets plus complete instructions to do the job right!

This Manifold Kit is designed to convert all Mercruiser Stern Drive Engines with GM 305 & 350 CID Blocks that have Log Style Exhaust Manifolds and Raw Water Cooling to the Newer More Efficient Center Rise Manifolds



18-1960-1*
MANIFOLD
 Replaces: 58759A10, A14
 Fits most Mercruiser (GM) Inline 6 Cyl. Engines
 Supplied with Mounting Package
 Use with:
 Mounting Kit: 18-8531



18-1962-1-1*
MANIFOLD
 Starboard
 Replaces: 65603A4, 65603A12
 Fits most Mercruiser Engines (Ford) V-8 Small blocks
 Supplied with Mounting Package
 Use with:
 Mounting Kit: 18-8509



**18-1999
ELBOW**
Replaces: Barr 20-0082
Comes with 18-4364 open Mounting Package -
Use with:
Manifold: 18-1997-1 or 18-1998-1
or 18-1898
Riser Gasket: 18-2854 open or
18-0476 blocked
Mounting Kit: 18-4364 open or
18-8535 blocked



**18-1970-1*
ELBOW**
Replaces: 98504A3
Fits V-6 & V-8 applications, 15° (3" O.D. Riser) Comes
with 18-0897 & brass plugs
Use with:
Manifold: 18-1952-1, 18-1953-2, 18-1957-1
Elbow Gasket: 18-0897 restrictor, 18-2849
open, 18-0672 blocked
Mounting Kit: 18-8529



**18-1971*
ELBOW**
Replaces: 76351A2
Fits most early model Mercruiser 140 HP (4 cyl)
applications
Replaces: Barr MC20-60426P
Use with:
Manifold: 18-1960-1, 18-1958-1, 18-1950-1
Elbow Gasket: 18-2833
Mounting Kit: 18-4362



**18-1992-1
EXHAUST ADAPTER**
For 3" I.D. Exhaust Hose
(As used in 18-1987 Exhaust Manifold Conversion Kit)
80°



**18-1972*
ELBOW**
Replaces: 76325A2
Fits most late Model 120, 140 HP Mercruiser applications
Use with:
Manifold: 18-1955-1, 18-1954-1,
18-1956-1, 18-1901
Elbow Gasket: 18-2833
Mounting Kit: 18-8552



**18-1973*
ELBOW**
Replaces: 55538A2
Fits most early Model 120 HP Mercruiser applications



**18-1991
ELBOW ADAPTER**
For use with 3" I.D. Exhaust Hose
Use with:
Manifold Riser: 18-1999
30°



**18-1978
ELBOW**
Replaces: 76771A3, A2
V-8 Inboard Applications Only
Use with:
Manifold: 18-1950-1, 18-1951-1,
18-1958-1, 18-1962-1
Elbow Gasket: 18-2833
Mounting Kit: 18-4362



**18-1905
ELBOW**
Replaces: 90880
Mercruiser 4 Cylinder 224cu. in. 3.7L
(Models: 165, 170, 180, 190).
Use with:
Manifold: Mercruiser 99908
Exhaust Elbow Mounting Gasket: 18-0113
Mounting Kit: 18-8500



**18-1937
ELBOW**
Replaces: 98562A6
Mercruiser 4 Cylinder 224cu. in. 3.7L (Models: 165, 170, 180, 190).
Use with:
Exhaust Elbow Mounting Gasket: 18-0881
Mounting Kit: 18-8530



**18-1974-1*
ELBOW**
Replaces: 98502A2
Fits V-6 & V-8 applications 0° (3" O.D. Riser)
Comes with 18-0897 gasket & brass plugs

* SEE APPLICATION CHART ON PAGE 671-675 FOR SPECIFIC MODELS



**18-1975-1-1*
RISER**

Replaces: 12076A2
Fits late Model Mercruiser 4 cyl. Engines
Use with:
Manifold: 18-1955-1, 18-1954-1, 18-1956-1, 18-1901
Riser Gasket: 18-2833
Mounting Kit: 18-8551
Bellow: 18-2748



**18-1976-1*
ELBOW**

Replaces: 44354A3, 807914A1
Fits most Mercruiser V-6 & V-8 applications 7" (4" O.D. Riser) Comes with 18-0897, 18-4263 & 18-4258
Use with:
Manifold: 18-1952-1, 18-1953-2, 18-1957-1
Riser Gasket: 18-0897 restrictor, 18-2849 open, 18-0672 blocked
Mounting Kit: 18-8505



**18-1939
RISER**

Replaces: Barr 20-0100, Marine Power 0992-593 Barr, Indmar and Marine Power Ford Small Block V8 302-351cu. in. GM Small Block V8 305-350cu. in., GM Big Block V8 454cu in.
Use with:
Manifold: 18-1997-1, 18-1998-1, 18-1898
Riser Gasket: 18-2854 open or 18-0476 blocked
Mounting Kit: 18-4364 open or 18-8535 blocked



**18-1907
RISER**

Replaces: Barr 20-0102, Indmar 53-2009 and 53-2018 Barr, Indmar Ford Small Block V8 302-351cu. in.
Use with:
Manifold: 18-1997-1, 18-1998-1
Riser Gasket: 18-2854 open or 18-0476 blocked
Mounting Kit: 18-4364 open or 18-8535 blocked



**18-1908K
MANIFOLD RISER SPACER KIT**

Replaces: 807476A6, 93320A5
Alpha/Bravo/Gen+/GenIV GM Small Block V-8 305, 350, 4.3L, 454, 5.0, 5.7L, 502, 7.4L, 8.2L, (3" Riser Kit)
Complete with Mounting Hardware. Center Rise 3" PACKAGED AS SET
Use with:
Manifold: 18-1952-1
3"



**18-1906
MANIFOLD SPACER**

Replaces: 61851A1
3" Spacer for 18-1950, 18-1951, 18-1958-1 & 18-1962-1 manifolds



**18-1908
MANIFOLD RISER SPACER - 3"**

Mercruiser GM V6 229 and 262cu.in. (Models: 185 and 205), GM Small Block V8 305-350cu.in. (Models: 200, 228, 230, 260 and 898), GM Big Block V8 454cu.in. (Models: 330, 340 and 7.4L)
Used with:
Manifolds: 18-1952-1, 18-1953-2, 18-1957-1



**18-1985
MANIFOLD SPACER - 6"**

Replaces: 93322
For: 229 and 262 V6, 305-350 Small Block V8, 454 Big Block V8
Used with:
Manifold: 18-1952-1, 18-1957-1, 18-1953-2



**18-1949
MANIFOLD SPACER**

Barr, Indmar and Marine Power Ford Small Block V8 302-351cu.in., GM Small Block V8 305-350cu.in., GM Big Block V8 454cu.in.
Used with:
Manifold: 18-1998-1, 18-1997-1 and 18-1898



**18-1990
MANIFOLD BLOCK OFF PLATE**

Replaces: 73813A1



**18-5021
END PLATE**
Replaces: Mercruiser 805629
Use with:
Manifold: 18-1954-1,
18-1955-1, 18-1956-1



**18-1995
MANIFOLD END PLATE**
Replaces: 47638
GM 4 cyl. 153 cu. in. For model
110/120 where carb. linkage
mounts to the rear of the engine



**18-4008
BLOCK-OFF PLATE**
Replaces: 60207
Use with:
Riser: 18-1971, 18-1978



**18-4009
MANIFOLD END PLATE**
Replaces: 60252A2
Use with:
Manifold: 18-1960-1, 18-1958-1,
18-1950-1, 18-1951-1
End Plate Gasket: 18-2832
Mounting Kit: 18-8512



PIPE PLUGS

Part #	Replaces	Thread Size	Description
18-4257	—	1/4"	Blacksteel Plug
18-4263	22-32802, 22-328022	1/8" - 27 NPT	Pipe Plug
18-4264	22-32803	3/8" - 18 NPT	Pipe Plug
18-4265	22-428611	3/4" - 14 NPT	Pipe Plug
18-8111①	22-36392	1/4 - 18 NPT	Pipe Plug
18-4258	22-33198A1 22-41622	3/4 - 14 NPT	Pipe Plug

56507 Pipe Sealant with Teflon® is recommended for use on plug threads.



RISER BOLTS

Part #	Replaces	Thread Size	Description
18-8410	10-43749	3/8"-16 x 5 3/4"	Use Without Remote Oil Filter
18-8411	10-44387	3/8"-16 x 6 3/4"	Use With Remote Oil Filter



**18-4362
EXHAUST ELBOW MOUNTING KIT**
Replaces: Barr MC20-60426P
Use with:
Elbow: 18-1971



**18-4363
EXHAUST ELBOW MOUNTING KIT**
Replaces: Barr FM-1-83-P
Use with:
Manifold: 18-1998-1



**18-4364 (Open)
EXHAUST ELBOW MOUNTING KIT**
Replaces:
Barr 20-0082-P
Use with:
Riser: 18-1999, 18-1907, 18-1939



**18-8500
EXHAUST ELBOW MOUNTING KIT**
Mercruiser 4 Cylinder 224cu.in. 3.7L
(Models: 165, 170, 180, 190)
Used with:
Elbow/Reservoir: 18-1905



**18-8505
EXHAUST ELBOW MOUNTING KIT**
Mercruiser GM V6 229 and 262cu.in.
(Models 185 and 205), GM Small Block
V8 305-350cu.in. (Models: 200, 228, 230,
260, 898), GM Big Block V8 454cu.in.
(Models: 330, 340 and 7.4L)
Used with:
Riser: 18-1976-1



**18-8508
EXHAUST MANIFOLD MOUNTING KIT**
Mercruiser GM 4 Cylinder 153cu.in.
(Early models 110/120), GM Inline
Cylinder 250cu.in.(Model: 160)
Used with:
Riser: 18-1973

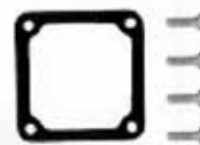

**18-8512
EXHAUST ELBOW
MOUNTING KIT**
Mercruiser GM 4 Cylinder 181cu.in. (Models:
120,140, 2.5L,3.0L), GM Inline 6 Cylinder
250-292cu.in. (Models: 165 and 200), Ford
Small Block V8 302-351cu.in. (Models:
215,225,233, 255,888), GM Small Block V8
305, 350cu.in.(Models: 198,228,898)
Used with:
Front Plate: 18-4009

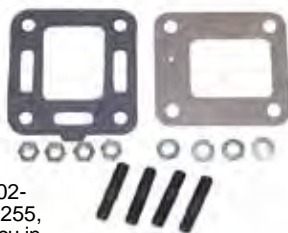

**18-8514
EXHAUST ELBOW
MOUNTING KIT**
Mercruiser Ford Small Block V8 302-
351cu.in. (Models: 215, 225, 233, 255,
888), GM Small Block V8 305-351cu.in.
(Models: 198,228,898)
Used with:
Riser: 18-1971 & 18-1978
(Not for Fresh Water/Closed Cooling
Systems)

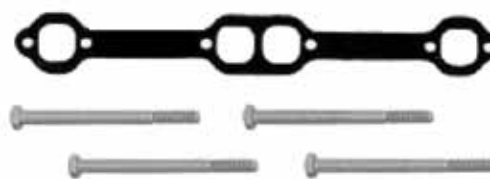

**18-8520
EXHAUST MANIFOLD MOUNTING KIT**
Mercruiser GM Small Block V8 305-350cu.
in. (Models: 198, 200, 228, 230, 260, 898)
Used with:
Manifold: 18-1950-1,18-1951-1, 18-1953-2

① This product is priced per piece. To order priced per package, please add -9 to the part number



**18-8529
EXHAUST ELBOW
MOUNTING KIT**
Mer cruiser GM V6 229 and 262cu.in.
(Models 185 and 205), GM Small
Block V8 305-350cu.in. (Models: 200,
228, 230, 260, 898), GM Big Block V8
454cu.in.(Models: 330, 340 and 7.4L)
Used with:
Riser: 18-1970-1



**18-8530
EXHAUST ELBOW MOUNTING KIT**
Mer cruiser 4 Cylinder 224cu.in. 3.7L
(Models: 165, 170, 180, 190)
Used with:
Elbow/Reservoir: 18-1937



**18-8531
EXHAUST MANIFOLD MOUNTING KIT**
Mer cruiser GM Inline 6 Cylinder 250cu.in.
(Models: 165 and 200)
Used with :
Manifold: 18-1960-1



**18-8532
EXHAUST MANIFOLD MOUNTING KIT**
Mer cruiser GM Big Block V8 454cu.in.
(Models: 330, 340 and 7.4L)
Used with:
Manifold: 18-1957-1



**18-8533
EXHAUST MANIFOLD MOUNTING KIT**
Mer cruiser GM V6 229 and 262cu.in.
(Models 185 and 205)
Used with:
Manifold: 18-1952-1



**18-8535 (Blocked)
EXHAUST ELBOW
MOUNTING KIT**
Barr, Indmar and Marine Power
Ford Small Block V8 302-351cu.in., GM
Small Block V8 305-350cu.in., GM Big Block
V8 454cu.in.
Used with:
Risers: 18-1939, 18-1999, and 18-1907



**18-8536
EXHAUST ELBOW MOUNTING KIT**
Barr, Indmar and Marine Power GM
Small Block V8 305-350cu.in.
Used with:
Manifold: 18-1997-1



**18-8538
EXHAUST MANIFOLD MOUNTING KIT**
Barr and Indmar Ford Small Block V8
302-351cu.in.
Used with:
Manifold: 18-1998-1



**18-8554
EXHAUST ELBOW MOUNTING KIT**
For: 229 and 262 ci V6, 305 and 350
SB V8, 454 Big Block V8.
Used with:
Riser Kit: 18-1908K and 18-1908 Spacer
Riser: 18-1970-1
Manifold: 18-1952-1



**18-8555
EXHAUST ELBOW MOUNTING KIT**
For: 229 and 262 ci V6, 305 and
350 SB V8, 454 Big Block V8.
Used with:
Riser Kit: 18-1908K and 18-1908 Spacer
Riser: 18-1976-1
Manifolds: 18-1952-1



**18-8556
EXHAUST ELBOW MOUNTING KIT**
For: 229 and 262 ci V6, 305 and 350
SB V8, 454 Big Block V8. Used to mount
Spacer 18-1985 to 18-1953-2,
18-1957-1 and 18-1952-1 Manifolds



HARDWARE KITS

Part #	Fits
18-8548	18-1950-1 & 18-1951-1 Manifold
18-8549	18-1955-1 Manifold
18-8551	18-1975-1 Exhaust Elbow









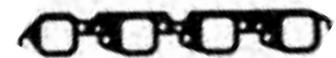









**18-0183
EXHAUST MANIFOLD GASKET**
Replaces: Mercruiser 27-73866
Volvo 3853742, 3852455, OMC 908717
Used with:
Manifold: 18-1962-1, 18-1938, 18-1998-1,
18-1996, 18-1979

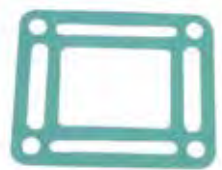

**18-0353
CARB MOUNTING GASKET**
Replaces: 27-58764
Used with:
Manifold: 18-1960-1

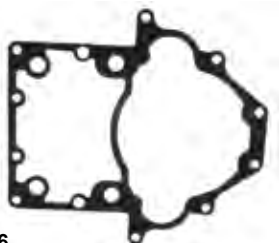

**18-0418
EXHAUST MANIFOLD GASKET**
Replaces: 27-46820
Use with :
Manifolds: 18-1957-1, 18-1982,
18-1929, 18-1933, 18-1898

 <p>18-0476 RISER BLOCK OFF GASKET Barr, Indmar & Marine Power Ford Small Block V8 302-351cu.in. Used with: Risers: 18-1939, 18-1999, 18-1907</p>	<p>PKG OF 2</p>  <p>18-0672 18-0672-9① EXHAUST ELBOW GASKET Replaces: 27-860231,8637251 Used with: Riser: 18-1970-1, 18-1976-1</p>	 <p>18-0872 EXHAUST MANIFOLD GASKET Replaces: Mercruiser 27-33395 GM 5.0L & 5.7L Use with: Manifold: 18-1950-1, 18-1951-1</p>	 <p>18-0881 EXHAUST ELBOW GASKET Replaces: 27-18272 Included in 18-8530 mounting kit Used with: Elbow: 18-1937</p>
<p>PKG. OF 2</p>  <p>18-0885 18-0885-9① EXHAUST ELBOW GASKET Replaces: 27-48042</p>	<p>PKG. OF 2</p>  <p>18-0897 (Restrictor) EXHAUST ELBOW GASKET Replaces: 27-41813 Used with: Riser: 18-1976-1, 18-1970-1</p>	<p>PKG. OF 2</p>  <p>18-1204 18-1204-9① EXHAUST MANIFOLD GASKET Replaces: 27-96429</p>	<p>PKG. OF 2</p>  <p>18-1210 18-1210-9① END CAP GASKET Replaces: 27-39923</p>
<p>PKG OF 2</p>  <p>18-2819 18-2819-9① EXHAUST ELBOW GASKET Replaces: 27-39915</p>	<p>PKG OF 2</p>  <p>18-2830 EXHAUST MANIFOLD GASKET 6 cyl. Replaces: 27-46401</p>	<p>PKG OF 2</p>  <p>18-2832 18-2832-9① MANIFOLD END CAP GASKET Replaces: 27-480431 Use with: Manifolds: 18-1951-1, 18-1950-1, 18-1954-1, 18-1958-1, 18-1955-1, 18-1956-1, 18-1960-1, 18-1962-1 End Plate: 18-4009</p>	
<p>PKG OF 2</p>  <p>18-2833 18-2833-9① EXHAUST ELBOW GASKET Replaces: 27-997772</p>	<p>PKG OF 2</p>  <p>18-2849 (Open) 18-2849-9① EXHAUST ELBOW GASKET Replaces: 27-87105-1, 27-818832, 27-863726 Use with: Elbow: 18-1976-1, 18-1970-1</p>	<p>PKG. OF 2</p>  <p>18-2854 (Open) 18-2854-9① EXHAUST ELBOW GASKET Replaces: Barr 01-0107 Use with : Riser: 18-1999, 18-1939, 18-1907</p>	
 <p>18-2896 EXHAUST MANIFOLD GASKET Replaces: 27-52546 GM 4 cyl. 153 cu. in. For model 110/120 where carb. linkage mounts to the rear of the engine</p>	<p>PKG. OF 2</p>  <p>18-2909 18-2909-9① EXHAUST MANIFOLD GASKET For: GM V-6 Used with: Manifold: 18-1952-1</p>	 <p>18-2912 EXHAUST MANIFOLD GASKET Replaces: 27-53354</p>	

① Priced per Package



18-2949
18-2949-9②
EXHAUST MANIFOLD GASKET
 Replaces: Barr CHV-47-000
 Use with:
 Manifold: 18-1997-1



18-0603
EXHAUST MANIFOLD GASKET SET
 For: Ford 302/351 CID Engines
 For use with **18-1998-1**



18-0604
EXHAUST MANIFOLD GASKET SET
 For: GM 305/350 CID Engines
 For use with **18-1997-1**



①**18-4218D** Display Package

18-4218
DRAIN TAP
 Replaces: 22-87238, 22-16951A1,
 22-16951T1, Q1 1/4" NPT
18-3223-9②
 Bulk pack of 12



①**18-4224D** Display Package

18-4224
DRAIN ELBOW ASSEMBLY
 Replaces: 22-806926A1



18-4226
DRAIN PLUG
 Replaces: 22-806608A1



18-4227
DRAIN ELBOW
 Replaces: 22-806926



18-4461
HOSE BARB
 Replaces: 22-807155
 3/4" - 14 NPT x 1" Hose
Corrosion Resistant Brass Fitting



18-8216
HOSE BARB
 Replaces: 22-36305
 Fits: Mercruiser- V6 (229 and 262ci), Small Block V8 (305-350ci), Big Block V8 (454ci)

① Items ending in "D" are Display Packaged - Regular number is Non-Display
 ② Priced per Package

MANIFOLD/MANIFOLD GASKET APPLICATION

Liter	Model	Note	CID	# Cyl	Stroke	Year Range	Serial Number Range	Exh Manifold Port	Exh Manifold Starboard	Exh Elbow	End Cap Front	End Cap Rear	Manifold Gasket	Exh Elbow Gasket
2.5L	120		153	4	4	1966-1982	2046625 - 6229717						27-52546	18-2819
2.5L	120		153	4	4		2324347 - 3377340					18-1995	18-2896	18-2819
2.5L	120		153	4	4		3377341 - 5192408					18-1995	18-2896	18-2819
2.5L	120		153	4	4		5192049 - 6229717					18-1995	18-2896	18-2819
2.5	120		153	4	4	1983-1986	6229718 - B5311853				18-4009		18-1204	18-2833
2.5L	2.5L		153	4	4	1987-1989	B531854 - C853255	18-1956-1			18-4009	18-4009	18-1204	18-2833
3.0L	140		181	4	4	1968-1982	2508261 - 6229717	18-1955-1		18-1971	18-4009	18-1990	18-2912	18-2833
3.0L	140		181	4	4		3332138 - 5157668	18-1955-1				18-4009	18-1203	18-2833
3.0L	140		181	4	4		5157669 - 6229717	18-1955-1				18-4009	18-1203	18-2833
3.0L	140		181	4	4	1983-1986	6229718 - B450800			18-1975-1	18-4009		18-1204	18-2833
3.0L	3.0L		181	4	4	1990-1994	C856559 & UP	18-1956-1		18-1975-1	18-4009		18-1204	18-2833
3.0L	3.0L		181	4	4	1987-1989	B450801 - C856558			18-1975-1	18-4009		18-1204	18-2833
3.0L	3.0L		181	4	4	1998-2003	L010042 - M679999	18-1956-1		18-1975-1	18-1990		18-1204	18-2833
3.0L	3.0L		181	4	4	2003-2010	M680000 & UP	18-1956-1		18-1975-1			18-0680	18-2833
3.0L	3.0LX		181	4	4	1990-1997	C856559 - K999999	18-1956-1		18-1975-1	18-1990		18-0680	18-2833
3.0L	3.0L MPI / 3.0L EC		181	4	4	2008-2010	A072812 & UP						18-0680	
	150			4	4		1666495 - 2048046						18-2830	
	160			4	4		2048022 - 2770031						18-2830	
3.7L	165		224	4	4	1987	B434941 - B774251		ⓐ	18-1937			18-0956	18-0881
3.7L	165		224	4	4	1987	B434941 - B774251		ⓑ				18-0956	
3.7L	165		224	4	4		2770032 & up	18-1960-1				18-4009	18-2830	18-2833
3.7L	170		224	4	4	1985-1986	6916779 - B434940		ⓐ	18-1937			18-0956	18-0881
3.7L	170		224	4	4	1985-1986	6916779 - B434940		ⓑ				18-0956	18-0113
3.7L	180		224	4	4	1987	B436391 - B775248		ⓐ	18-1937			18-0956	18-0881
3.7L	180		224	4	4	1987	B436391 - B775248		ⓑ				18-0956	18-0113
3.7L	190		224	4	4	1985-1986	6916779 - B436390		ⓐ	18-1937			18-0956	18-0881
3.7L	190		224	4	4	1985-1986	6916779 - B436390		ⓑ				18-0956	18-0113
3.7L	3.7L		224	4	4	1988-1989	B774252 & UP		ⓐ	18-1937			18-0956	18-0881
3.7L	3.7L		224	4	4	1988-1989	B774252 & UP		ⓑ				18-0956	
3.7L	3.7LX		224	4	4	1988-1989	B775249 & UP		ⓐ	18-1937			18-0956	18-0881
3.7L	3.7LX		224	4	4	1988-1989	B775249 & UP		ⓑ				18-0956	18-0113
	470		224	4	4	1976-1977	4208730 - 4625579						18-0956	18-2833
	470 MCM / 470 MIE		224	4	4	1977-1982	4625580 - 6218036						18-0956	18-2833
	470		224	4	4	1983-1984	6218037 - 6916778						18-0956	18-0113
	485		224	4	4	1980-1982	5685394 - 6218036						18-0956	
	488		224	4	4	1983-1984	6170297 - 6916778						18-0956	18-0113
	140		194	6	4	1963	1538930 - 1725960						18-2830	
	150		230	6	4	1964-1966	1666495 - 2048046						18-2830	
	160		250	6	4	1967-1969	2048022 - 2770031						18-2830	
	165		250	6	4	1970-1981	2770032 - 5813433	18-1960-1		18-1971	18-4009	18-1990	18-2830	18-2833
	200		292	6	4	1969	2453769 - 2712072	18-1960-1		18-1971		18-1990	18-2830	18-2833
	185	4bb1	229	6	4	1983-1984	6330183 - 6919655	18-1952-1		18-1970-1			18-2909	18-0897
	175		262	6	4	1987	B527955 - B773242	18-1952-1		18-1952-1			18-2909	18-0897

- ⓐ For engines with aluminum exhaust manifolds
- ⓑ For engines with cast iron exhaust manifolds
- ⓐ 3" (76mm) O.D. & 0 degree down angle
- ⓑ 3" (76mm) O.D. & 15 degree down angle
- ⓐ 4" (102mm) O.D.
- ⓐ 2 piece exhaust manifold
- ⓑ 1 piece exhaust manifold
- ⓐ Has a rectangular elbow mounting bolt pattern
- ⓑ Has a square elbow mounting bolt pattern
- ⓐ In-line applications
- ⓑ V-drive applications
- ⓐ Standard rise
- ⓑ 2" (51mm) rise
- ⓐ 3" (76mm) rise
- ⓑ 6" (152mm) rise
- ⓐ Port
- ⓑ Starboard
- ⓐ Engines with risers or closed cooling may require a different gasket than listed
- ⓐ Exhaust manifold with external water rail
- ⓑ Exhaust manifold w/o external water rail
- ⓐ 1 piece exhaust manifold is n/a. Engine must be converted to the 2 piece exhaust system
- ⓐ Engines with easy drain system
- ⓑ Engines with multi-point drain system
- ⓐ Intermediate collector housing

MANIFOLD/MANIFOLD GASKET APPLICATION (Cont.)

Table with columns: Liter, Model, Note, CID, # Cyl, Stroke, Year Range, Serial Number Range, Exh Manifold Port, Exh Manifold Starboard, Exh Elbow, End Cap Front, End Cap Rear, Manifold Gasket, Exh Elbow Gasket. Rows list various engine models and their corresponding gasket specifications.

- ⊕ For engines with aluminum exhaust manifolds
⊕ For engines with cast iron exhaust manifolds
⊕ 3" (76mm) O.D. & 0 degree down angle
⊕ 3" (76mm) O.D. & 15 degree down angle
⊕ 4" (102mm) O.D.
⊕ 2 piece exhaust manifold
⊕ 1 piece exhaust manifold
⊕ Has a rectangular elbow mounting bolt pattern
⊕ Has a square elbow mounting bolt pattern
⊕ In-line applications
⊕ V-drive applications
⊙ Standard rise
⊙ 2" (51mm) rise
⊙ 3" (76mm) rise
⊙ 6" (152mm) rise
⊕ Port
⊙ Starboard
⊙ Engines with risers or closed cooling may require a different gasket than listed
⊙ Exhaust manifold with external water rail
⊙ Exhaust manifold w/o external water rail
⬅ 1 piece exhaust manifold is in-line. Engine must be converted to the 2 piece exhaust system
♣ Engines with easy drain system
♣ Engines with multi-point drain system
♣ Intermediate collector housing

Features...

- Manufactured to meet or exceed OEM specifications.
- High Efficiency Filter
- Field-tested and approved.
- Anti-drainback valves where required.



OIL FILTERS

- ① Do not use on V-6 engines equipped with remote oil filter kit
- Display Packaged

SEE PAGES 152-154 FOR ADDITIONAL INFORMATION

Part #	O.E. #	Application
18-7824-1*	54111, 14957, 32716, 35-802885Q, 35-866340K01, 35-866340Q03	GM Engines ① (Short Filter)
18-7871	35-805809, T	D7.3L Diesel
18-7875*	60565, 35-802886Q	Ford Engines (Long Filter)
18-7876*	52731, 35-16595T, T1, Q, 32-802885Q, 14957	GM Engines (Long Filter)
18-7878-1*	803470, Q	60 & 80 HP Engines (Renault) (Short Filter)
18-7879*	41815, 35-802884Q, 35-883702Q, K	GM V-6 Engines

OIL PANS AND GASKET



18-1232
OIL PAN GASKET
Replaces: 27-811566



Part No.	OE	OE No.	Application
18-0612	MerCruiser	809910	1 piece rear main seal; GM Small Block V8 (Right Handed Dipstick)
18-0613	MerCruiser	93476	2 piece rear main seal; GM Small Block V8 (Right Handed Dipstick)
18-0614	MerCruiser	845668T	1 piece rear main seal; GM Big Block V8 (Right Handed Dipstick)
18-0615	MerCruiser	93477T	2 piece rear main seal; GM Big Block V8 (Right Handed Dipstick)
18-0616	MerCruiser	14244T	1 piece rear main seal; GM V6 (Right Handed Dipstick)

CYLINDER HEAD ASSEMBLIES

All cylinder heads are new castings and complete assemblies with new- stainless steel valves, hardened steel exhaust seats, valve springs, valve locks, and retainers.
All GM cylinder heads utilize high performance screw-in rocker arm studs in place of factory press in rocker arm studs.



18-4484
CYLINDER HEAD ASSEMBLY
Fits: 5.7L V-8 GM (1969-86) with 12 intake manifold mounting bolts, perimeter mount valve cover



18-4485
CYLINDER HEAD ASSEMBLY
Replaces: 938-883490 1
Fits: 5.7L V-8 GM (1987-95) with press in rocker arm studs with 12 intake manifold mounting bolts- (4 inside intake manifold bolts at 23 degrees), center mount valve covers



18-4486
CYLINDER HEAD ASSEMBLY
Replaces: 938-883297 1, 938-803860T
Fits: 5.7L V-8 GM Vortec (1996-Up) with press in rocker arm studs with 8 intake manifold mounting bolts, composite valve cover



18-4489
CYLINDER HEAD ASSEMBLY
Replaces: 936-5544, 936-810840
Fits: 2.5L/3.0L GM (1968-95) (non MerCruiser LX models) (1968-95)



18-4491
CYLINDER HEAD ASSEMBLY
Replaces: 938-827178 1
Replaces 4.3L Vortec V-6 (1996-Up) with screw in rocker arm studs (non-adjustable valve train), 8 intake manifold mounting bolts, center mount valve cover. NOTE: not for use with engines using factory roller rocker arms.



18-4495
CYLINDER HEAD ASSEMBLY
Replaces: 949-4057, 949-5798
Fits: (1980& Up) 5.0L Ford with D-shape 58 cc combustion chamber



18-4501
CYLINDER HEAD
Fits: 5.0L Vortec



18-4502
CYLINDER HEAD
High Performance
Aluminum cylinder head sold in pairs only. This utilizes a 185cc intake runner/62cc exhaust runner and 2.02/1.60 stainless valves placed in a 72cc combustion chamber.
Fits: 5.7, 6.2L GM small block V-8



**18-4492
ROCKER ARM ASSEMBLY**
Replaces: 35329
Fits: MCM/MIE Gm V6 & V8(283, 305 & 350 cid) engines



**18-7508
POWER STEERING PUMP**
Replaces: 16792A39



**18-8227
POWER STEERING PUMP PULLEY**
Replaces: 73873A1
For: Sterndrives with v-belt



**18-8297
POWER STEERING PUMP PULLEY**
Replaces: 861578
For: Sterndrives with serpentine belt



**18-1400
HYDRAULIC LIFTER**
Replaces: 17340
GM 4.3L/V-6 Late/5.0L/5.7L



**18-1401
HYDRAULIC LIFTER**
Replaces: 56153
Ford 302/351
Ford 5.0L & 5.8L



**18-1402
HYDRAULIC LIFTER**
Replaces: 72638
GM 2.5L/120
For: Mercruiser 140 (S/N 2508261-6229717),
140/3.0L (S/N 6229718-up), 3.0L/3.0LX (S/N C856559-up)

**ALL PISTONS
ARE SUPPLIED COMPLETE WITH PISTON RINGS AND WRIST PIN.**



RINGS

STD	REPLACES MERCUISER
18-3928	39-74381A1
18-3937	39-17464
18-3940	39-67127
18-3942	39-67132
18-3944	39-75609
.020	
18-3939	39-66217
.030	
18-3938	39-17465

PISTONS

STD	REPLACES MERCUISER
18-4180	736-2343
18-4161	733-3819 733-803850T
18-4109	778-9441A3 759-80661A7
18-4173	735-6370 735-9686 735-808674 735-850097
.020	
18-4160	733-3818
.030	
18-4134	778-9441A5 759-80661A8
18-4164	735-6371 735-9687 735-850098
18-4178	735-9715



PISTON/RING APPLICATION

Liter	Model	Note	CID	# Cyl	Stroke	Year	Serial Number	PISTONS				RINGS			Qty. Eng.	
								Std.	Note	0.02	0.03	Note	Std.	0.02		0.03
7.4L	7.4L BRAVO		454	8	4	1988-1991	B771113 - D603117	-	-	-	-	-	-	-	8	
7.4L	7.4L BRAVO I GEN V / 7.4L BRAVO II GEN V		454	8	4	1992-1995	D603118 - F800699	-	1	-	-	-	-	-	8	
7.4L	7.4L BRAVO I GEN V / 7.4L BRAVO II GEN V		454	8	4	1992-1996	D603118 - F800699	-	2	-	-	-	-	-	8	
7.4L	7.4L BRAVO III GEN V		454	8	4	1992-1995	D603118 - F800699	-	3	-	-	-	-	-	8	
7.4L	7.4L BRAVO III GEN V		454	8	4	1992-1996	D603118 - F800699	-	4	-	-	-	-	-	8	
7.4L	7.4L BRAVO GEN VI		454	8	4	1996-1997	F800700 - K999999	-	-	-	-	-	-	-	8	
7.4L	7.4L EFI GEN VI / 7.4L MIE GEN VI / 7.4L GEN VI MIE		454	8	4	1996-1997	F874815 - K999999	-	-	-	-	-	-	-	8	
7.4L	7.4L MIE W/HURTH		454	8	4	1988-1992	B788366 - D715493	-	-	-	-	-	-	-	8	
7.4L	7.4L W/HURTH		454	8	4		C391564 - & Up	-	-	18-4189	-	-	18-3940	18-3950	18-3941	8
7.4L	7.4L MIE GEN V		454	8	4	1992-1995	D715494 - F820141	-	5	-	-	-	-	-	8	
7.4L	7.4L MIE GEN V		454	8	4	1992-1996	D715494 - F820141	-	5	-	-	-	-	-	8	
7.4L	7.4L MIE GEN VI		454	8	4	1996-1997	F820142 - K999999	-	-	-	-	-	-	-	8	
7.4L	7.4L MPI GEN VI		454	8	4	1998-2001	L010003 - M024330	-	-	-	-	-	-	-	8	
7.4L	7.4L MPI GEN V / 7.4L MIE GEN V		454	8	4	1995-1996	F563052 - F820103	-	-	-	-	-	-	-	8	
7.4L	7.4L MPI GEN VI / 7.4L MIE GEN VI / 7.4LH GEN VI		454	8	4	1996-1997	F820104 - K999999	-	-	-	-	-	-	-	8	
7.4L	7.4L MPI L-29 GEN VI / 7.4L MIE L-29 GEN VI		454	8	4	1998-2001	L002006 - M025999	-	-	-	-	-	-	-	8	
7.4L	7.4LX BRAVO GEN VI / 7.4L BRAVO EFI		454	8	4	1996-1997	F802000 - K999999	-	-	-	-	-	-	-	8	
7.4L	7.4LX BRAVO GEN V / 7.4L MPI GEN V		454	8	4	1996	F802010 - F801999	-	-	-	-	-	-	-	8	
7.4L	7.4LX BRAVO GEN VI / 7.4L MPI GEN VI		454	8	4	1996-1997	F802000 - K999999	-	-	-	-	-	-	-	8	
7.9L	390		482	8	4	1969-1970	2781129 - 2825059	-	-	-	-	-	-	-	8	
7.9L	460 TRS		482	8	4	1983-1986	4179554 - 6181046	-	-	-	-	-	-	-	8	
8.1L	496		482	8	4	2001-2010	M025000 & UP	-	9	-	-	-	-	-	8	
8.1L	496		496	8	4	2001-2010	M025000 & UP	-	10	-	-	-	-	-	8	
8.2L	465		502	8	4	1990-1992	C849992 - D725646	-	-	-	-	-	-	-	8	
8.2L	465 GEN V		502	8	4	1992-1994	D725647 - F213244	-	-	-	-	-	-	-	8	
8.2L	500 GEN V		502	8	4	1994-1996	F213293 - F745159	-	-	-	-	-	-	-	8	
8.2L	500 GEN VI		502	8	4	1997-1999	K745195 - L601036	-	-	-	-	-	-	-	8	
8.2L	500 EFI		502	8	4	1999-2005	L001477 - M907127	-	-	-	-	-	-	-	8	
8.2L	502 MAG BRAVO		502	8	4	1990-1992	C878221 - D824588	-	-	-	-	-	-	-	8	
8.2L	502 MAG BRAVO GEN V		502	8	4	1992-1993	D824589 - F114528	-	-	-	-	-	-	-	8	
8.2L	502 MAG EFI		502	8	4	1993-1996	D640650 - F802599	-	-	-	-	-	-	-	8	
8.2L	502 MAG MPI GEN VI		502	8	4	1996-2001	F802600 - M024999	-	-	-	-	-	-	-	8	
8.2L	525 EFI		502	8	4	2003-2010	M900146 & UP	-	-	-	-	-	-	-	8	
8.2L	575 Sci		502	8	4	2001-2005	L306696 - M950526	-	-	-	-	-	-	-	8	
8.2L	600 SC		502	8	4	1991-1992	D456489 - D456768	-	-	-	-	-	-	-	8	
8.2L	600 SC GEN V		502	8	4	1992-1996	D725676 - F877642	-	-	-	-	-	-	-	8	
8.2L	600 SC GEN VI		502	8	4	1997-2000	K000227 - L601186	-	-	-	-	-	-	-	8	
8.2L	8.2L MAG EC		502	8	4	2010	A350340 & UP	-	-	-	-	-	-	-	8	
8.2L	8.2L MIE / 8.2L EC		502	8	4	2010	A350802 & UP	-	-	-	-	-	-	-	8	
8.2L	8.2L MIE W/HURTH		502	8	4	1990-1992	C878221 - D857199	-	-	-	-	-	-	-	8	
8.2L	8.2L MIE GEN V		502	8	4	1993-1995	D857200 - F819619	-	-	-	-	-	-	-	8	
8.2L	8.2L MPI GEN VI / 8.2L MIE GEN VI / 8.2LH GEN VI		502	8	4	1996-2001	F819620 - L674200	-	-	-	-	-	-	-	8	
8.9L	500 BULLDOG		540	8	4	1990-2001	C577254 - M050281	-	-	-	-	-	-	-	8	
8.9L	575		540	8	4	1986-1992	A677429 - D763716	-	7	-	-	-	18-3937	18-3939	18-3938	8

- | | |
|--|--|
| <ul style="list-style-type: none"> (1) Cast Aluminum (Use with GM Engine Code 1XW) (2) Cast aluminum (Use with GM Engine Code 4XW) (3) Forged Aluminum (Use with GM Engine Code 3UB) (4) Cast Aluminum (Use with GM Engine Code 4XX) (5) Cast Aluminum (Use with GM Engine Code 2XY) (6) Cast Aluminum (Use with GM Engine Code 4XY) | <ul style="list-style-type: none"> (7) Flat Head (8) Forged Aluminum, Recessed Head (9) Starboard (10) Port (11) .010 (25mm) Oversize |
|--|--|

N.L.A. No longer available from O.E. source

N.L.A. No longer available from O.E. source

 <p>ROD BEARINGS</p> <table border="1" style="width: 100%; border-collapse: collapse;"> <thead> <tr> <th>Part #</th> <th>Size</th> <th>Replaces Mercuriser:</th> </tr> </thead> <tbody> <tr><td>18-1148</td><td>Std.</td><td>68704A1</td></tr> <tr><td>18-1308</td><td>Std.</td><td>23-85701</td></tr> <tr><td>18-1309</td><td>.010</td><td>23-85704</td></tr> <tr><td>18-1327</td><td>Std.</td><td>23-11992</td></tr> <tr><td>18-1329</td><td>Std.</td><td>23-85677</td></tr> <tr><td>18-1333</td><td>.010</td><td>23-85691</td></tr> <tr><td>18-1334</td><td>Std.</td><td>23-85726</td></tr> <tr><td>18-1337</td><td>.010</td><td>23-811858</td></tr> <tr><td>18-1341</td><td>.020</td><td>23-85705</td></tr> </tbody> </table>	Part #	Size	Replaces Mercuriser:	18-1148	Std.	68704A1	18-1308	Std.	23-85701	18-1309	.010	23-85704	18-1327	Std.	23-11992	18-1329	Std.	23-85677	18-1333	.010	23-85691	18-1334	Std.	23-85726	18-1337	.010	23-811858	18-1341	.020	23-85705	 <p>MAIN BEARINGS</p> <table border="1" style="width: 100%; border-collapse: collapse;"> <thead> <tr> <th>Part #</th> <th>Per Eng.</th> <th>Size</th> <th>Replaces Mercuriser:</th> <th>Part #</th> <th>Per Eng.</th> <th>Size</th> <th>Replaces Mercuriser:</th> </tr> </thead> <tbody> <tr> <td>18-1300</td> <td>①</td> <td>Std.</td> <td>23-818465</td> <td>18-1316</td> <td>①</td> <td>.010</td> <td>23-818471</td> </tr> <tr> <td>18-1311</td> <td>①</td> <td>Std.</td> <td>23-801793</td> <td>18-1317</td> <td>①</td> <td>Std.</td> <td>23-818469</td> </tr> <tr> <td>18-1315</td> <td>①</td> <td>Std.</td> <td>23-818473</td> <td></td> <td></td> <td></td> <td></td> </tr> </tbody> </table>	Part #	Per Eng.	Size	Replaces Mercuriser:	Part #	Per Eng.	Size	Replaces Mercuriser:	18-1300	①	Std.	23-818465	18-1316	①	.010	23-818471	18-1311	①	Std.	23-801793	18-1317	①	Std.	23-818469	18-1315	①	Std.	23-818473					 <p>CAM BEARINGS</p> <table border="1" style="width: 100%; border-collapse: collapse;"> <thead> <tr> <th>Part #</th> <th>Per Eng.</th> <th>Replaces Mercuriser:</th> </tr> </thead> <tbody> <tr> <td>18-1339</td> <td>1 ①</td> <td>23-43293</td> </tr> </tbody> </table>	Part #	Per Eng.	Replaces Mercuriser:	18-1339	1 ①	23-43293
Part #	Size	Replaces Mercuriser:																																																																				
18-1148	Std.	68704A1																																																																				
18-1308	Std.	23-85701																																																																				
18-1309	.010	23-85704																																																																				
18-1327	Std.	23-11992																																																																				
18-1329	Std.	23-85677																																																																				
18-1333	.010	23-85691																																																																				
18-1334	Std.	23-85726																																																																				
18-1337	.010	23-811858																																																																				
18-1341	.020	23-85705																																																																				
Part #	Per Eng.	Size	Replaces Mercuriser:	Part #	Per Eng.	Size	Replaces Mercuriser:																																																															
18-1300	①	Std.	23-818465	18-1316	①	.010	23-818471																																																															
18-1311	①	Std.	23-801793	18-1317	①	Std.	23-818469																																																															
18-1315	①	Std.	23-818473																																																																			
Part #	Per Eng.	Replaces Mercuriser:																																																																				
18-1339	1 ①	23-43293																																																																				
Rod bearings sold individually, 1 per rod			① Complete engine set																																																																			

 <p>18-0518 VALVE STEM SEAL Replaces: 26-34217</p>	 <p>18-4023 VALVE STEM SEAL Replaces: 26-75413 For: 165, 170, 180, 190 4 cyl. (224 CID) SN 6916779 & later</p>	 <p>18-4022 VALVE STEM SEAL Replaces: 26-75988 For: 330 (SN 4623115 & later), 340 (1B) (SN 5889914 & later), 454 Mag (SN A631894 & later)</p>	<p>PKG. OF 8</p>  <p>18-4024 18-4024-9^② VALVE STEM SEAL Replaces: 26-97664</p>
 <p>One Piece Rear Main Seals</p> <p>18-1234 Replaces: 26-811554 For: 7.4L, GL, GI, GSI: 8.2L, GL</p> <p>18-0519 Replaces: 26-14240 4.3L/3.0L/5.0L 5.7L</p> <p>18-0864 Replaces: 26-90925</p>	 <p>Two Piece Rear Main Seals</p> <p>18-0528 Replaces: 26-56868</p> <p>18-1211 Replaces: 26-58203</p>	 <p>Timing Cover Seals</p> <p>18-1213 Replaces: 26-79223, 26-97335, 26-59341</p> <p>18-1233 Replaces: 26-8219471</p> <p>18-0578 Replaces: 26-67388</p>	

MERCURUISER SEAL APPLICATION

Model	Serial No.	Rear Main Crankshaft Seal	Timing Cover Seal
120/2.5L	1666601 & UP	—	18-1213
120/2.5L	2786857 & UP	18-1211	18-1213
140/3.0L & LX	2508261 & UP	—	18-1213
140/3.0L & LX	6229718 & UP	18-1211	18-1213
150/160/165/200 (I/L-6)	1666495 & UP	—	18-1213
150/160/165/200 (I/L-6)	2770032 & UP	18-1211	18-1213
175/185/205/262/4.3L (V-6)	6330183 & UP	18-1211	18-1213
200/228/225/230/250/255/260/270			
280/300/320/5.0L/5.7L/898(V-8)	2453769 & UP	18-1211 ^①	18-1213
215	2781153 & UP	18-0528	—
224I/L4	ALL	18-0864	18-0578
225 FORD	3885721 & UP	18-0528	—
5.0L/5.7L, 4.3L, 3.0L Std. Rotation	"All" one piece seal	18-0519	18-1213
340 (7.4L)	4623115 & UP	—	18-1233
370 TRS	5889914 & UP	—	18-1233
400 TRS	4179554 & UP	—	18-1233
420	A398941 & UP	—	18-1233
440 TRS	4179554 & UP	—	18-1233
454 MAGNUM	A631894 & UP	—	18-1233
460 TRS	4179554 & UP	—	18-1233
7.4L/8.2L/454/502 Std. Rotation	"All" one piece seal	18-1234	18-1233
7.4 BRAVO	B771113 & UP	—	18-1233
888 (188)	3108723 & UP	18-0528	—

① Lrg. Journal Crankshaft GM Engines

② Priced per Package



MANIFOLD & EXHAUST MANIFOLD GASKET SETS



18-0403
INTAKE GASKET KIT
 Replaces: 27-805722A1
 For: MCM 370, 400, 325, 454, 502 Mag, 7.4L Bravo II & MIE 8.2L1978-1997



18-0404
INTAKE GASKET KIT
 Replaces: 27-805403A1
 For: MCM/MIE 454 Mag MPI, 7.4L/LX MPI & 8.2L MPI 1993-UP



18-0603
EXHAUST MANIFOLD GASKET SET
 For: Ford 302/351 CID Engines
 For use with 18-1998-1

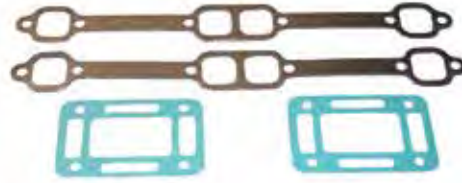

18-0604
EXHAUST MANIFOLD GASKET SET
 For: GM 305/350 CID Engines
 For use with 18-1997-1



18-4347-1
EXHAUST MANIFOLD GASKET SET
 For: GM 175, 185, 205 (229 & 262 CID)

— CONTAINS —

Part #	Description	O.E. #	Qty.
18-0897	Exhaust Elbow Mounting Gasket	27-41813-1	2
18-2909	Exhaust Manifold to Cyl. Head Gasket	27-99757	2



18-4348
EXHAUST MANIFOLD GASKET SET
 For: GM 454, 525 (7.4L & 8.2L)

— CONTAINS —

Part #	Description	O.E. #	Qty.
18-0418	Manifold to Cylinder Head Gasket	27-46820	2
18-0897	Exhaust Elbow Mounting Gasket	27-41813-1	2



18-4408
INTAKE MANIFOLD GASKET SET
 Replaces: 27-11977
 For: GM 262 CID Engines 175, 185 and 205 HP



18-4349
EXHAUST MANIFOLD GASKET SET
 For: GM 200, 228, 230, 260, 898 (5.0 & 5.7L)

— CONTAINS —

Part #	Description	O.E. #	Qty.
18-0872	Exhaust Manifold Gasket	27-33395	2
18-0897	Exhaust Elbow Mounting Gasket	27-41813-1	2



18-4367
EXHAUST MANIFOLD GASKET SET
 Replaces: 27-99777A1
 For: GM 153 & 181 (2.5 & 3.0L) CID Eng's; 120 & 140 HP S/N 6229718 & UP
 (With Siamese Port Cylinder Heads)

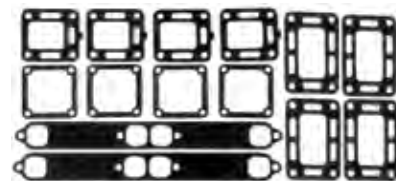

18-4394
EXHAUST MANIFOLD GASKET SET
 Replaces: 27-33395A2
 For: GM 350 (5.7L) CID Eng; 250 HP S/N 4768000-4908849 255 HP S/N 5195909 & UP

— CONTAINS —

Part #	Description	O.E. #	Qty.
18-2832	Manifold End Cap Gasket	27-48043	4
18-2833	Exhaust Elbow Gasket	27-99777-2	4
18-0872	Exhaust Manifold Gasket	27-33395	2
18-0885	Exhaust Elbow Gasket	27-48042	4

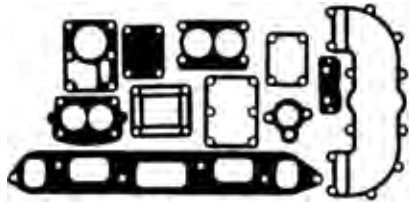

18-4395
EXHAUST MANIFOLD GASKET SET
 Replaces: 27-35898A-4
 For: GM 153 (2.5L) CID Eng;
 120 HP S/N 2046625-6229717

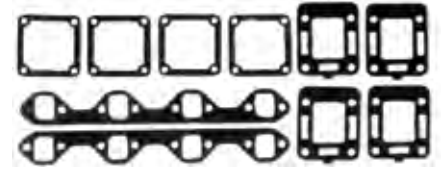

18-4399
EXHAUST MANIFOLD GASKET SET
 Replaces: 27-54566A1
 For: Ford 302/351 (5.0L & 5.8L) CID Eng; All 888 (188 HP)
 & 233 HP, 255 HP S/N 3258728-4175498
 — CONTAINS —

Part #	Description	O.E. #	Qty.
18-0183	Exhaust Mounting Gasket	27-46820	2
18-2832	Manifold End Cap Gasket	27-48043-1	4
18-2833	Exhaust Elbow to Gasket	27-99777-2	4



18-4397
EXHAUST MANIFOLD GASKET SET
 Replaces: 27-46820A1
 For: GM 454 (7.4L) CID Eng; All 325, 350, 400 HP Jet Drives 330 HP S/N 6083144 & BELOW
 — CONTAINS —

Part #	Description	O.E. #	Qty.
18-0418	Exhaust Mounting Gasket	27-46820	2
18-0885	Exhaust Elbow Mounting Gasket	27-48042	4
18-2832	Manifold End Cap Gasket	27-48043-1	4

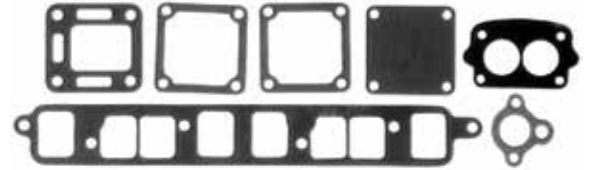

18-4398
EXHAUST MANIFOLD GASKET SET
 Replaces: 27-53354A1
 For: GM 181 (3.0L) CID Eng; 140 HP S/N 3332137-6229717
 (Without Siamese Port Cylinder)

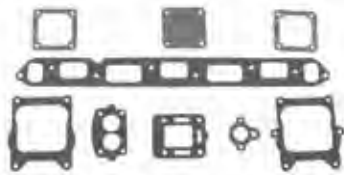

18-4396
EXHAUST MANIFOLD GASKET SET
 Replaces: 27-46401A1
 For: 250 (4.1L) CID Eng; 165 HP S/N 2770032 & UP
 — CONTAINS —

Part #	Description	O.E. #	Qty.
18-2830	Intake Exhaust Gasket	27-46401	1
18-2831	Thermostat Gasket	27-47590-1	1
18-2832	Manifold End Cap Gasket	27-48083-1	2
18-2833	Exhaust Elbow Gasket	27-99777-2	1
18-0353	Carb. Mounting Gasket	27-58764	1
18-0356	Carb. Mounting Gasket	27-64692	1
18-0928	Exhaust End Cap Gasket	27-73814	1



18-4376
TIMING CHAIN GASKET SET
 Replaces: 27-34895A2
 For: GM 305 & 350 CID Eng. 200, 225,
 228, 230, 250, 255, 260, 270, 280 HP 898
 (198 HP) & 5.7L (SKI)
 — CONTAINS —

Part #	Description	O.E. #	Qty.
18-0976	Seal Retainer Cover Gasket	27-14250	1
18-0889	Fuel Pump Mounting Gasket	27-34213	1
18-0891	Water Pump Mounting Gasket	27-34897	2
18-0876	Fuel Pump Mounting Gasket	27-34898	1
18-0893	Water Pump Back. Plate Gasket	27-35380	1
18-0185	Oil Filter & Adapter Seal	27-91892	1
18-0331	Vent Adapter Screw Gasket	27-35593	1

CYLINDER HEAD AND INTAKE MANIFOLD GASKET SETS



18-4383
 For: GM 153 (2.5L) CID Eng;
 S/N 2324347 & UP Includes 18-3880 Head Gasket



18-4384
 For: GM 181 (3.0L) CID Eng;
 S/N 2508261-6229717 (Except 3.0LX)

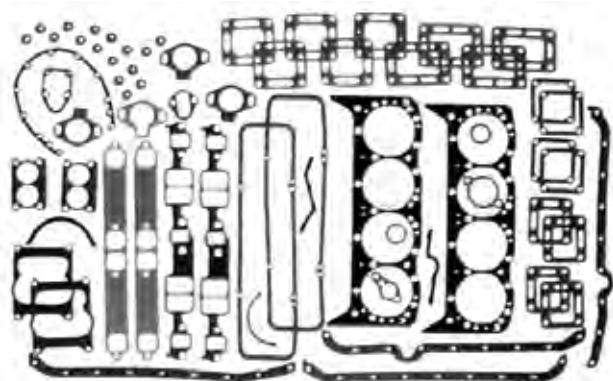

18-4386
 For: GM 305 & 350 (5.0L & 5.7L) CID Eng; With Heads (1987 & Earlier)

— CONTAINS —

Part #	Description	O.E. #	Qty.
18-0976	Timing Chain Cover Gasket	27-14250	1
18-0868	Intake Manifold Gasket	27-17145	1
18-0872	Exhaust Manifold Gasket	27-33395	2
18-0897	Exhaust Elbow Mounting Gasket	27-41813	2
18-0885	Exhaust Elbow Mounting Gasket	27-48042	4
18-2917	Lower Thermostat Housing Gasket	27-53045-1	1
18-0153	Port Dip Gasket	27-85817A1	1
18-2848	Quadrajel Base Gasket	27-58457-2	2
18-2849	Exhaust Elbow To Manifold Gasket	27-87105-1, 27-818832	4
18-3876	Head Gasket	27-75611	2
18-2554	Thermostat Gasket	27-41812	1
18-2832	Manifold End Cap Gasket	27-48043-1	4
18-2553	Thermostat Gasket	27-47510	1
18-2833	Exhaust Elbow To Manifold Gasket	27-99777-2	4
18-2844	Thermostat Cover Gasket	27-48818-1	1
18-0889	Fuel Pump Housing Gasket	27-34213	1
18-0891	Water Pump Mounting Gasket	27-34897	1
18-0905	Oil Pan Drain Plug Gasket	27-49955	1
18-0876	Water Pump Mounting Gasket	27-34898	1
18-0994	Carb. Mounting Gasket	27-70143-1	2
18-0518	Seal	26-34217	16
18-2845	Valve Cover Gasket	121-122	2

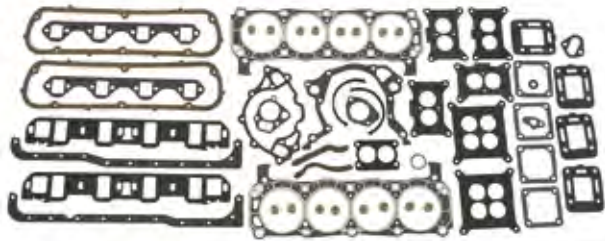

18-4385
 For: Ford 302 (5.0L) CID Eng; 215, 225 & 888 (188 HP)
 Includes 18-3883 Head Gasket

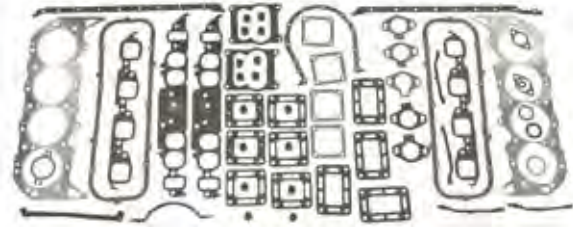

18-4387
 Replaces: 27-801853
 For: GM 454 (7.4L) CID Eng; Production Models
 Oval Port
 Includes 18-3877 Head Gasket



18-0465
INTAKE MANIFOLD GASKET SET
 Replaces: 27-65184
 For: GM 454 CID Engines, 325, 330, 340, 350 HP
 and 454 Magnums, 7.4L

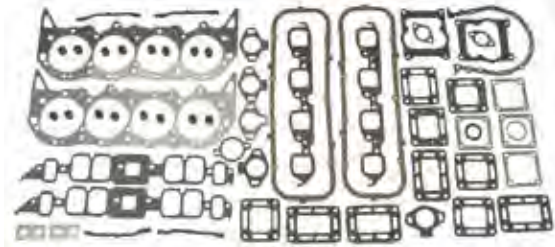

18-4365
EXHAUST MANIFOLD GASKET SET
 Replaces: 27-801855
 For: GM 454 (7.4L) CID Eng; Production Models
 Rectangular Port
 Includes 18-3877 Head Gasket



18-4388
INTAKE MANIFOLD GASKET SET
 Replaces: 27-11977A88, A92
 For: GM 262 CID Eng; 175, 185 & 205 HP, 4.3L
 Includes 18-3879 Head Gasket

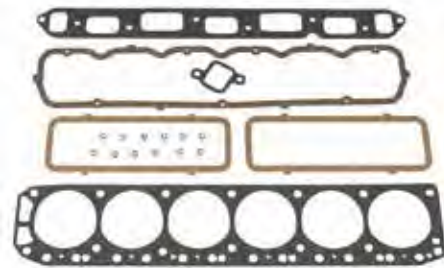

18-4389
INTAKE MANIFOLD GASKET SET
 Replaces: 27-47453A1
 For: All GM 165 HP (S/N 270032 & UP) & Inline 6 cyl.
 250 CID

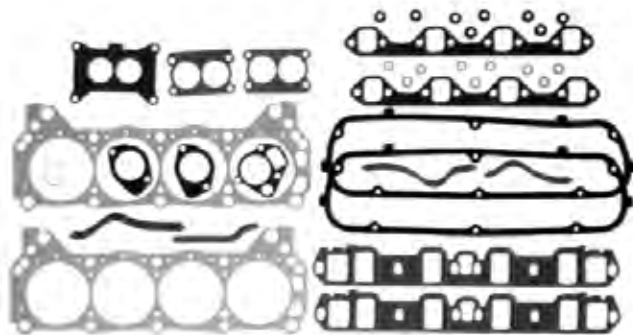

18-4391
INTAKE MANIFOLD GASKET SET
 Replaces: 27-64763A2
 For: Ford 351 CID Eng; 233 HP S/N 4173000-4500860, 5.8L
 Includes 18-3883 Head Gasket

18-4392
INTAKE MANIFOLD GASKET SET
 Replaces: 27-75611A2
 For: GM 305 & 350 CID Eng, 898 (198 HP) 200, 228,
 230/260 (Inboard) 230, 250, 255, 260, 280 & 5.7L Ski

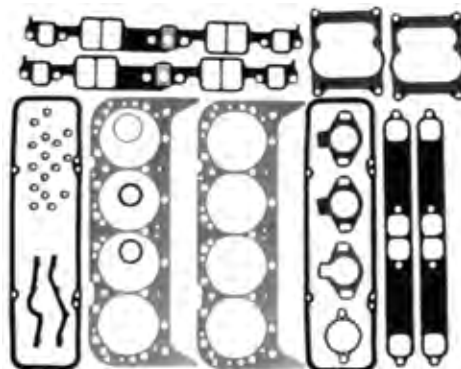

— CONTAINS —

Part #	Description	O.E. #	Qty.
18-0868	Intake Manifold Gasket	27-17145	1
18-0872	Exhaust Manifold Gasket	27-33395	2
18-2848	Quadrajct Base Gasket	27-52457-2	2
18-3876	Head Gasket	27-75611	2
18-2553	Thermostat Gasket	27-47510	1
18-2844	Thermostat Cover Gasket	27-48818-1	1
18-2554	Thermostat Gasket	27-41812	2
18-2917	Lower Thermostat Housing Gasket	27-53045-1	1
18-2845	Valve Cover Gasket	27-11999	2
18-0518	Seal	26-34217	16

OVERHAUL GASKET SETS

(Sets do not include Front and Rear Crankshaft Seals)

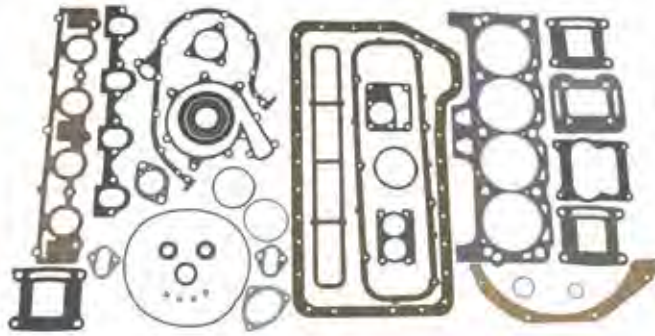

18-4381

Replaces: 27-43186A1

For: 224 (3.7L) CID Eng; 165, 170, 180, 190 HP
S/N 6916779 & UP

— CONTAINS —

Part #	Description	O.E. #	Qty.
18-0175	O-Ring	25-26543	4
18-0860	O-Ring	25-62700	1
18-0864	Seal	26-90925	1
18-0881	Exhaust Elbow Mounting Gasket	27-18272	1
18-0992	Exhaust Manifold Mounting Gasket	27-68715	1
18-0994	Carburetor Mounting Gasket	27-70143-1	1
18-0158	Intake Manifold Gasket	27-70905	1
18-0111	Exhaust Elbow Mounting Gasket	27-89657	2
18-0160	Lower Exhaust to Intake Manifold Gasket	27-94136	1
18-0113	Exhaust Elbow Mounting Gasket	27-97542	1
18-2843	Thermostat Cover Gasket	27-74830	1
18-2848	QuadraJet Base Gasket	27-52457-2	1
18-3878	Head Gasket	27-13709T	1
18-7121	O-Ring	25-35027	1
18-0874	Distributor Gasket	27-34486	1
18-0185	Seal	27-91892	1
18-2555	Thermostat Gasket	27-89656-1	1
18-0889	Fuel Pump Mounting Gasket	27-34213	1
18-4366	Oil Pan Gasket Set	27-72479A5	1
18-0387	Flywheel Cover Gasket	27-94976	1
18-0172	Oil Seal	26-97530	2

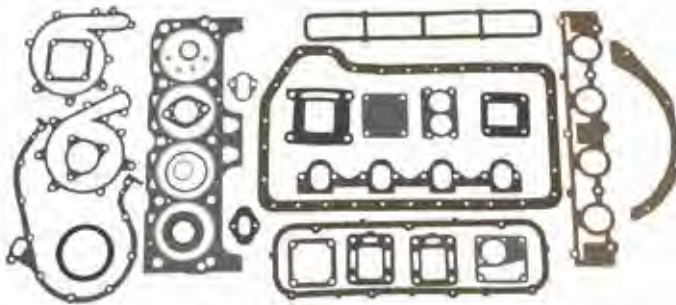

18-4382

Replaces: 27-74830A3

For: 224 (3.7L) CID Eng; 470 S/N 4208730 & UP

— CONTAINS —

Part #	Description	O.E. #	Qty.
18-0864	Seal	26-90925	1
18-0992	Exhaust Manifold Mounting Gasket	27-68715	1
18-0158	Intake Manifold Gasket	27-70905	1
18-0950	Impeller Cover Gasket	27-88046	1
18-0954	Exhaust Mounting Gasket	27-92720	1
18-0113	Exhaust Elbow Mounting Gasket	27-97542	1
18-2832	Manifold End Cap Gasket	27-48043-1	2
18-2833	Exhaust Elbow To Manifold Gasket	27-99777-2	2
18-2843	Thermostat Cover Gasket	27-74830	1
18-3878	Head Gasket	27-13709T	1
18-0175	O-Ring	25-26543	4
18-0889	Fuel Pump Mounting Gasket	27-34213	1
18-7121	O-Ring	25-35029	1
18-0874	Distributor Gasket	27-34486-3	1
18-0928	Manifold End Cap Gasket	27-73814	1
18-0994	Carb. Mounting Gasket	27-70143-1	1
18-2555	Thermostat Cover Gasket	27-89656-1	1
18-4366	Oil Pan Gasket Set	27-72479A5	1
18-0387	Flywheel Cover Gasket	27-94976	1

MISCELLANEOUS GASKET SETS

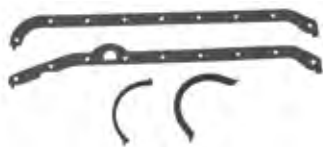

18-0153

OIL PAN GASKET SET

Replaces: 27-85817A1

For: Mercruiser GM 350 CID (5.7L)



18-0340

OIL PAN GASKET SET

Replaces: 27-49949

For: Mercruiser 160/165 (6 cyl.)



18-1239

OIL PAN GASKET

Replaces: 27-810846T

For: Mercruiser 3.0L GM 181



18-0348

OIL PAN GASKET SET

Replaces: 27-52550

For: Mercruiser GM 454/502 CID Eng; (7.4L and 8.2L)



18-1237

OIL PAN GASKET

Replaces: 27-138651



18-0466

OIL PAN GASKET SET

Replaces: 27-14901A1

For: Mercruiser GM 153/181 (2.5L & 3.0L)



18-1238

INTAKE GASKET SET

Replaces: 24-824326

For: Mercruiser 4.3L/LX models, pre SN F802999



18-1231

INTAKE GASKET

Replaces: 27-818188-1

For: Rectangular port high performance big block Chevy



18-0405

OIL PAN GASKET

Replaces:

27-14247-1, 27-883964

For: Mercruiser GM 262 CID Eng. (4.3L)



18-0407
OIL PAN GASKET SET
 Replaces: 27-64798
 For: Mercruiser: 215, 225, 888



18-0410
INTAKE MANIFOLD GASKET SET
 Replaces: 27-75648
 For: Ford 5.0L/302, 5.8L/351 CID Engine; (233HP)
 S/N 3108723 & UP



18-0411
OIL PAN GASKET SET
 Replaces: 27-90458A1
 For: Mercruiser GM 350 CID (5.7L)
 Starboard Dipstick



18-0611
OIL PAN GASKET SET
 Replaces: 27-75483
 For: Mercruiser Ford 351 CID Eng.

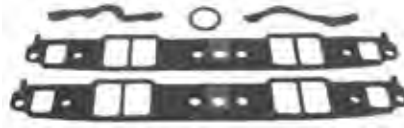

18-0868
INTAKE MANIFOLD GASKET SET
 Replaces: 27-17145
 For: Mercruiser 305, 350

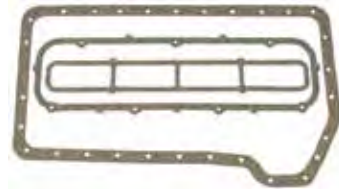

18-4366
OIL PAN GASKET SET
 Replaces: 27-72479A5
 For: Mercruiser 224 CID (3.7L)

18-4375
TIMING CHAIN GASKET SET
 Replaces: 27-34213A2
 For: Mercruiser GM 153 & 181 CID Eng's: 110, 120, 130, 140, 150, 160 & 165 HP; 2.5L & 3.0L



— CONTAINS —

Part #	Description	O.E. #	Qty.
18-0889	Fuel Pump Mounting Gasket	27-34213	1
18-0887	Timing Cover Gasket	27-49953	1
18-0948	Distributor Gasket	27-87707	1
18-0327	Water Pump Gasket	27-33956	1



18-4377
TIMING CHAIN GASKET SET
 Replaces: 27-42457A1
 For: GM 262 CID Eng: 175, 185 & 205 HP

18-4378
TIMING CHAIN GASKET SET
 Replaces: 27-54529A1
 For: GM 454 CID Eng. 325, 330, 340 & 350 Inboards & 300TRS



— CONTAINS —

Part #	Description	O.E. #	Qty.
18-0889	Fuel Pump Mounting Gasket	27-34213	1
18-0903	Water Pump Gasket	27-49110	2
18-0980	Timing Chain Gasket	27-54529	1





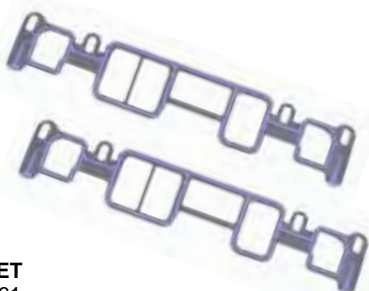



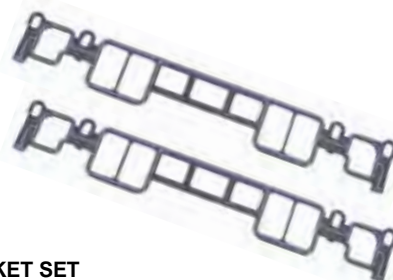









18-4380
TIMING CHAIN GASKET SET
 Replaces: 27-68714A6
 For: Mercruiser 224 CID Eng.
 165, 170, 180, 190, 470, 485 & 488 HP



18-0487
INTAKE GASKET SET
 Replaces: 27-8243261
 Fits: MCM 262 Mag & 4.3L/LX/LH/LXH Gen II (1996-up)



18-0488
INTAKE GASKET SET
 Replaces: 27-807473A1
 Fits: MCM 350 Mag, 5.0L & 5.7L/LX Gen II (1996-up)

 <p>18-2946 HEAD GASKET Replaces: 27-52364, 27-81084 For: GM 181 (3.0L) CID Eng.</p>	 <p>18-3874 HEAD GASKET Replaces: 27-811546 For: (8.2L) 502 CID</p>	 <p>18-3876 HEAD GASKET Replaces: 27-75611 For: GM 305 (5.0L)/350 (5.7L) CID Eng.</p>	
 <p>18-3877 HEAD GASKET Replaces: 27-13687 For: GM 454 (7.4L) CID Eng.</p>	 <p>18-3878 HEAD GASKET Replaces: 27-13709T For: Mercruiser 224 (3.7L) CID Eng. Model 470</p>	 <p>18-3879 HEAD GASKET Replaces: 27-11986, 27-816460 For: GM 262 (4.3L) CID Eng.</p>	
 <p>18-3880 HEAD GASKET Replaces: 27-34273, 27-810841 For: GM 153 (2.5L), (3.0L) CID Eng.</p>	 <p>18-3881 HEAD GASKET Replaces: 27-47453 For: GM 250 (4.1L) CID (6 cyl) Eng.</p>	 <p>18-3883 HEAD GASKET Replaces: 27-75647 For: Ford 302 (5.0L) 351 (5.8L) CID Eng.</p>	
 <p>18-3887 HEAD GASKET Replaces: 27-850470 For: (7.4L) 454 CID GEN V and IV (1992-up)</p>	 <p>18-0353 CARB MOUNTING GASKET Replaces: 27-58764</p>	 <p>18-0354 CARB MOUNTING GASKET Replaces: 27-60715</p>	 <p>18-0685 VALVE COVER GASKET Replaces: 27-73666 224 CID (3.7L)</p>
 <p>18-0356 CARB MOUNTING GASKET (For Rochester) Replaces: 27-64692</p>	 <p>18-0357 CARB MOUNTING GASKET Replaces: 27-65577</p>	<p>PKG. OF 2</p>  <p>18-0876 18-0876-9① FUEL PUMP GASKET For GM 4.3L, 5.0L & 5.7L Replaces: 27-34898</p>	<p>PKG. OF 2</p>  <p>18-0889 18-0889-9① FUEL PUMP GASKET For GM 4.3L, 5.0L & 5.7L Replaces: 27-34213</p>

SEE PAGES 166-167 FOR OUR COMPLETE LINE OF GASKET SEALANTS

① Priced per Package



18-0360
CARB MOUNTING GASKET
 Replaces: 27-70142



18-0462
CARB MOUNTING GASKET
 Replaces: 27-48399

Model	Year	S/N
250	1968-69	2314301-2639854
270	1969-72	2851074-3385720
325	1969-70	2278747-3042730
390	1969-70	2781129-3042731



18-0463
CARB MOUNTING GASKET
 (For Weber)
 Replaces: 27-814210



18-0467
CARB MOUNTING GASKET
 (For Weber)
 Replaces: 27-41610

PKG OF 2



18-0994
18-0994-9^①
CARB MOUNTING GASKET
 Replaces: 27-70143-1

PKG OF 2



18-2848
18-2848-9^①
CARB BASE GASKET
 Replaces: 27-524572

PKG. OF 2



18-0874
18-0874-9^①
DISTRIBUTOR GASKET
 For GM V6 & V8
 Replaces: 27-344863
 For: 2.6L (1989), 3.5L (1989), 4.3L (1987-93), 5.0L (1987-88), 5.7L (1987-92), 7.4L (1988-93), 8.2L (1992-93)

PKG OF 2



18-0948
18-0948-9^①
DISTRIBUTOR GASKET
 Replaces: 27-87707
 4 Cyl.



18-0349
THERMOSTAT GASKET
 Replaces: 27-54506
 For: Ford V-8

PKG. OF 2



18-2552
18-2552-9^①
THERMOSTAT GASKET
 Replaces: 27-331792

PKG. OF 2



18-0667
18-0667-9^①
CONNECTOR COVER GASKET
 Replaces: 27-995061

PKG. OF 2



18-2553
18-2553-9^①
THERMOSTAT GASKET
 Replaces: 27-47510
 GM V-6, V-8

PKG. OF 2



18-2554
18-2554-9^①
THERMOSTAT GASKET
 Replaces: 27-41812,
 27-90556
 V-6 & V-8

PKG. OF 2



18-2555
18-2555-9^①
THERMOSTAT GASKET
 Replaces: 27-896561
 4 Cyl.

PKG OF 2



18-2831
18-2831-9^①
THERMOSTAT GASKET
 Replaces: 27-475901
 4 & 6 Cyl.

PKG OF 2



18-2834
18-2834-9^①
THERMOSTAT GASKET
 Replaces: 27-60208
 Ford V-8

PKG OF 2



18-2843
18-2843-9^①
THERMOSTAT GASKET
 Replaces: 27-74830
 470

PKG OF 2



18-2844
18-2844-9^①
THERMOSTAT GASKET
 Replaces: 27-488181
 V-8

PKG OF 2



18-2917
18-2917-9^①
THERMOSTAT GASKET
 Replaces: 27-530451

















PKG OF 2

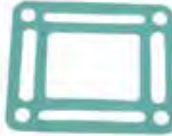

18-0398
18-0398-9^①
THERMOSTAT GASKET
 Replaces: 27-530451

SEE PAGES 166-167 FOR OUR COMPLETE LINE OF GASKET SEALANTS

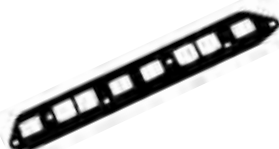
^① Priced per Package

 <p>18-0111 EXHAUST ELBOW GASKET Replaces: 27-89657</p>	 <p>18-0113 EXHAUST ELBOW GASKET Replaces: 27-97542, 27-856705</p>	<p>PKG OF 2</p>  <p>18-0672 18-0672-9① EXHAUST ELBOW GASKET Replaces: 27-860231, 8637251</p>	 <p>18-0365 HEAT EXCHANGER END GASKET Replaces: 27-75450 224 CID</p>
 <p>18-0389 HEAT EXCHANGER END GASKET Replaces: 27-99960</p>	 <p>18-0881 EXHAUST ELBOW GASKET Replaces: 27-18272</p>	<p>PKG. OF 2</p>  <p>18-0885 18-0885-9① EXHAUST ELBOW GASKET Replaces: 27-48042</p>	 <p>18-0897 EXHAUST ELBOW GASKET Replaces: 27-41813</p>
<p>PKG. OF 2</p>  <p>18-0928 18-0928-9① MANIFOLD END CAP GASKET Replaces: 27-73814</p>	 <p>18-0954 EXHAUST ELBOW GASKET Replaces: 27-92720</p>	<p>PKG OF 2</p>  <p>18-2819 18-2819-9① EXHAUST ELBOW GASKET Replaces: 27-39915</p>	<p>PKG OF 2</p>  <p>18-2832 18-2832-9① MANIFOLD END CAP GASKET Replaces: 27-480431</p>
<p>PKG OF 2</p>  <p>18-2833 18-2833-9① EXHAUST ELBOW GASKET Replaces: 27-997772</p>	<p>PKG OF 2</p>  <p>18-2849 18-2849-9① EXHAUST ELBOW GASKET Replaces: 27-87105-1, 27-818832, 27-863726</p>	 <p>18-0158 INTAKE MANIFOLD GASKET Replaces: 27-70905 For: 3.7L</p>	 <p>18-0183 EXHAUST MANIFOLD GASKET Replaces: 27-73866</p>
 <p>18-0418 EXHAUST MANIFOLD GASKET Replaces: 27-46820</p>	<p>PKG. OF 2</p>  <p>18-2830 EXHAUST MANIFOLD GASKET Inline 6 cyl. Replaces: 27-46401</p>	 <p>18-0680 EXHAUST MANIFOLD GASKET Replaces: 27-815528</p>	 <p>18-2896 EXHAUST MANIFOLD GASKET Replaces: 27-52546</p>

SEE PAGES 166-167 FOR OUR COMPLETE LINE OF GASKET SEALANTS

① Priced per Package

PKG. OF 2



18-2909
18-2909-9①
EXHAUST MANIFOLD GASKET
 Replaces: 27-99757



18-0872
EXHAUST MANIFOLD GASKET
 Replaces: 27-33395
 GM 5.0L & 5.7L



18-2912
EXHAUST MANIFOLD GASKET
 Replaces: 27-53354



18-0956
EXHAUST MANIFOLD GASKET
 Replaces: 27-68715

PKG. OF 2



18-1204
18-1204-9①
EXHAUST MANIFOLD GASKET
 Replaces: 27-96429



18-0664
VALVE COVER GASKET
 Replaces: 27-17467
 For: GM 305/350, 5.0 & 5.7L



18-2845
VALVE COVER GASKET
 Replaces: 27-11999
 V-8 GM 305/350 CID, 5.0 & 5.7L



18-25001
VALVE COVER GASKET
 Replaces: 27-14765
 Fits: GM 454, 7.4L



18-25002
VALVE COVER GASKET
 Replaces: 27-811588
 Fits: GM 454, 502, (1992-UP)
 Recessed Grooved Valve Cover



18-0311
VALVE COVER GASKET
 Replaces: 27-11988
 For: 4.3 Litre
 262 CID



18-0346
VALVE COVER GASKET
 Replaces: 27-49936
 For: GM 250 CID (4.1L), 160/165/200 (6 cyl.)



18-0347
VALVE COVER GASKET
 Replaces: 27-52145
 For: GM 153 & 181 CID (2.5L & 3.0L)



18-0352
VALVE COVER GASKET
 Replaces: 27-56173
 For: Ford 302/351 CID (5.0L & 5.8L)

PKG. OF 2



18-0464
18-0464-9①
VALVE COVER GASKET
 Replaces: 27-49121
 For: GM 454/502 CID (7.4L & 8.2L)

Model	Year	S/N
330	1977-81	4623115-6083144
7.4 Bravo	1988-91	B771113-D603117
454 Mag	1986-92	A631894-D805068
370 TRS	1978-87	4179554-B714586
400 TRS	1980-86	4179554-B457644
400 TRS	1983-86	4179554-B485220
460 TRS	1983-86	4179554-6181046
502 Mag Bravo	1990-92	C878221-D824588



18-0468
TIMING COVER GASKET
 Replaces: 27-811572
 GM 4.3L, 5.0L & 5.7L

PKG. OF 2



18-0887
18-0887-9①
TIMING COVER GASKET
 Replaces: 27-49953
 4 & 6 Cyl.

PKG. OF 2



18-0976
18-0976-9①
TIMING CHAIN COVER GASKET
 Replaces: 27-14250



18-0980
TIMING COVER GASKET
 Replaces: 27-54529
 GM 7.4L

















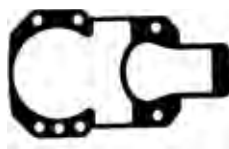

PKG. OF 2



18-0328
18-0328-9①
PUSH ROD/LIFTER COVER GASKET
 Replaces: 27-34208
 153 & 181 CID, 120/140 (4 Cyl.)

SEE PAGES 166-167 FOR OUR COMPLETE LINE OF GASKET SEALANTS

① Priced per Package

 <p>18-0329 PUSH ROD/LIFTER COVER GASKET Replaces: 27-34209 For: 140/150/160/165 (6 cyl.)</p>	 <p>18-2815 PUSH ROD COVER GASKET Replaces: 27-814703 For: 3.0L</p>	<p>PKG. OF 2</p>  <p>18-1210 18-1210-9① END CAP GASKET Replaces: 27-39923</p>	<p>PKG. OF 2</p>  <p>18-0185 18-0185-9① REMOTE OIL SEAL Replaces: 27-91892</p>
 <p>18-1240 OUTDRIVE SEAL For Bravo Replaces: 12708</p>	<p>PKG OF 5</p>  <p>18-2516 18-2516-9① BRAVO OUTDRIVE SEAL Replaces: 16755</p>	<p>PKG. OF 2</p>  <p>18-2556 18-2556-9① DRIVE SHAFT HOUSING TO BELL HOUSING GASKET Replaces: 27-35996, A1</p>	 <p>18-2743 OUTDRIVE HOUSING GASKET Replaces: 27-94996-2, Q2</p>
<p>PKG OF 5</p>  <p>18-2820 18-2820-9① OUTDRIVE GASKET Replaces: 27-64818, Q4</p>	<p>PKG OF 5</p>  <p>18-2840 18-2840-9① BELL HOUSING GASKET Replaces: 27-35982</p>	<p>PKG OF 2</p>  <p>18-2847 18-2847-9① OUTDRIVE GASKET Replaces: 27-54014 For: E, H, TR, TRS</p>	 <p>18-0386 WATER PUMP BODY GASKET Replaces: 27-94914</p>
<p>PKG. OF 2</p>  <p>18-0894 18-0894-9① WATER POCKET COVER GASKET Replaces: 27-55810, 27-55810 -1</p>	 <p>18-0916 WATER PUMP GASKET Replaces: 27-8052151</p>	<p>PKG. OF 2</p>  <p>18-0903 WATER PUMP GASKET Replaces: 27-49110 454 CID</p>	 <p>18-0147 WATER PUMP GASKET For Ford V-8 Replaces: 27-56880</p>
 <p>18-0327 WATER PUMP GASKET Replaces: 27-33956 4 & 6 Cyl.</p>	<p>PKG. OF 2</p>  <p>18-0891 18-0891-9① WATER PUMP MOUNTING GASKET Replaces: 27-34897 For: GM 4.3L, 5.0L & 5.8L</p>	<p>PKG. OF 2</p>  <p>18-0893 18-0893-9① WATER PUMP BACK-IN PLATE GASKET Replaces: 27-35380 GM 4.3L, 5.0L & 5.7L</p>	<p>PKG OF 2</p>  <p>18-2564 18-2564-9① IMPELLER GASKET Alpha I - Generation 2 Replaces: 27-430331</p>

SEE PAGES 166-167 FOR OUR COMPLETE LINE OF GASKET SEALANTS

① Priced per Package

 <p>18-0950 IMPELLER HOUSING GASKET Replaces: 27-88046 224 CID</p>	<p>PKG OF 2</p>  <p>18-2565 18-2565-9① IMPELLER GASKET Alpha I - Generation 2 Replaces: 27-430472</p>	<p>PKG OF 2</p>  <p>18-2566 18-2566-9① IMPELLER GASKET Alpha I - Generation 2 Replaces: 27-817277</p>	<p>PKG OF 2</p>  <p>18-2823 18-2823-9① LOWER WATER PUMP GASKET Replaces: 27-32769, 27-19553</p>
<p>PKG OF 2</p>  <p>18-2824 18-2824-9① UPPER WATER PUMP GASKET Replaces: 27-32770, 27-19551</p>	<p>PKG OF 2</p>  <p>18-2825 18-2825-9① WATER PUMP BASE GASKET Replaces: 27-32771</p>	<p>PKG OF 2</p>  <p>18-2826 18-2826-9① WATER PUMP BASE GASKET Replaces: 27-85610-1, 27-85670-4</p>	<p>PKG OF 2</p>  <p>18-2914 18-2914-9① WATER PUMP GASKET Replaces: 27-856081</p>
<p>PKG OF 2</p>  <p>18-2915 18-2915-9① WATER PUMP GASKET Replaces: 27-856091, 27-858524</p>	<p>PKG OF 2</p>  <p>18-2919 18-2919-9① WATER PUMP GASKET Replaces: 27-426311</p>	<p>PKG OF 2</p>  <p>18-0342 POWER TRIM HOSE CONNECTOR PLATE GASKET Replaces: 27-476441</p>	<p>PKG OF 2</p>  <p>18-0388 POWER TRIM HOSE CONNECTOR GASKET Replaces: 27-988231</p>
<p>PKG. OF 2</p>  <p>18-0322 18-0322-9① REAR SEAL GASKET Replaces: 27-14247, 27-881715 GM 5.0L & 5.7L</p>	<p>PKG OF 2</p>  <p>18-3289 DOUBLE LIP SEAL Replaces: 26-864319 For: Gen II Upper Housing</p>	<p>PKG OF 2</p>  <p>18-2094 OIL SEAL Replaces: 26-88416 Fits: 120/140(1978-82), 165 (1978-81), 260 (1978-82), 470 (1978-82), 485 (1980-82), 898/228 (1978-82), Alpha I/Gen II (1991 & Up), Blackhawk (1994-95), Bravo I/II/III (1988-98), R/MR/Alpha One Sterndrive and Transom (1983-90)</p>	<p>PKG OF 2</p>  <p>18-2944 18-2944-9① SEAL RING GASKET (Quad Ring) Replaces: 26-45577</p>
<p>PKG OF 2</p>  <p>18-2945 18-2945-9① 18-29451-9① (PKG OF 50) DRAIN SCREW GASKET Replaces: 12-20260, 12-19183, 12-191832 Used in most lower units and sea water pumps</p>	<p>PKG OF 5</p>  <p>18-2948 18-2948-9① RUBBER WASHER Replaces: 12-49221-1, 12-49221</p>	<p>PKG OF 2</p>  <p>18-2349 SHIFT SHAFT SLEEVE Replaces: 23-67370 For: Ratios 1.47, 1.62, 1.81 & 1.94. For: Gen II (1998 & up), (0L100040 & up) 1/4" Thick</p>	<p>PKG. OF 2</p>  <p>18-0905 OIL PAN DRAIN PLUG GASKET Replaces: 27-49955</p>

SEE PAGES 166-167 FOR OUR COMPLETE LINE OF GASKET SEALANTS

① Priced per Package

<p>PKG. OF 2</p>  <p>18-4267 18-4267-9① SHIFT SHAFT WASHER Replaces: 12-29395</p>	<p>PKG. OF 3</p>  <p>18-0681 18-0681-9① WASHER Replaces: 12-32834</p>	<p>PKG. OF 5</p>  <p>18-0203 18-0203-9① BELL HOUSING WASHER Replaces: 12-35935 All Mercruiser Stern drives 1963-1998</p>	<p>PKG. OF 5</p>  <p>18-2316 18-2316-9① SHIFT SHAFT WASHER Replaces: 12-77674 Used over 18-2349 sleeve For: Ratios 1.47, 1.62, 1.81 & 1.94. For: Gen II (1998 & up), (0L100040 & up) 1/8" Thick</p>																		
 <p>18-0318 WASHER Replaces: 12-815472</p>	<p>PKG OF 2</p>  <p>18-4270 18-4270-9① WASHER Replaces: 12-36001</p>	<p>PKG OF 5</p>  <p>18-2340 18-2340-9① SHIFT SHAFT WASHER Replaces: 12-31266 For: #1R/MR (1/16" Thick)</p>	<p>PKG OF 2</p>  <p>18-2343 18-2343-9① PINION NUT WASHER Replaces: 12-92721 For: MR/Alpha/Gen II</p>																		
 <p style="text-align: center;">SCREWS</p> <table border="1" data-bbox="771 1050 1201 1249"> <thead> <tr> <th>Part #</th> <th>Description</th> <th>O.E. #</th> </tr> </thead> <tbody> <tr> <td>18-2361</td> <td>(PKG. OF 2)</td> <td></td> </tr> <tr> <td>18-2361-9①</td> <td>Lower Unit Mounting Screw</td> <td>10-30206</td> </tr> <tr> <td>18-3197</td> <td>Water Pick-Up Insert Screw</td> <td>10-76156</td> </tr> <tr> <td>18-3230</td> <td>Gear Housing To Drive Shaft Housing Screw</td> <td>10-816601</td> </tr> <tr> <td>18-3231</td> <td>Upper Drive Shaft Top Cover Screw</td> <td>10-98794</td> </tr> </tbody> </table>			Part #	Description	O.E. #	18-2361	(PKG. OF 2)		18-2361-9①	Lower Unit Mounting Screw	10-30206	18-3197	Water Pick-Up Insert Screw	10-76156	18-3230	Gear Housing To Drive Shaft Housing Screw	10-816601	18-3231	Upper Drive Shaft Top Cover Screw	10-98794	<p>PKG OF 5</p>  <p>18-3721 18-3721-9① NUT Replaces: 11-13439-1, 11-859116 For: MR/Alpha</p>
Part #	Description	O.E. #																			
18-2361	(PKG. OF 2)																				
18-2361-9①	Lower Unit Mounting Screw	10-30206																			
18-3197	Water Pick-Up Insert Screw	10-76156																			
18-3230	Gear Housing To Drive Shaft Housing Screw	10-816601																			
18-3231	Upper Drive Shaft Top Cover Screw	10-98794																			
 <p>18-3236 HOUSING ALIGNMENT BUSHING Replaces: 23-32632 For: #1R/MR/Alpha</p>	 <p>18-4272 WELCH PLUG Replaces: 19-32652</p>	 <p>18-4273 WELCH PLUG Replaces: 19-42682</p>	 <p>18-2140 ENGINE MOUNT BOLT KIT For: Mercruiser I</p>																		
 <p>18-2141 ENGINE MOUNT BOLT KIT Replaces: 10-97934A1 For: R/MR/Alpha I/ Gen II/Bravo</p>	 <p>18-3728 LOCK NUT Replaces: 11-99298, 11-863332</p>	 <p>18-3729 MOTOR MOUNT BOLT Replaces: 10-97934</p>	 <p>18-2193 REAR ENGINE MOUNT Replaces: 99297A1 For 120/140 HP S/N 6229717 & UP; All 224 CID Blocks; All 898, 200, 228, 230, 260, 300 & 320 HP; All 350-454 Magnums</p>																		

① Priced per Package

① 18-2614D 



**18-2614
OUTDRIVE GASKET SET
1967-1982**
Replaces: 27-64818A1, 27-64818T4,
27-64818Q4

**18-2615
OUTDRIVE GASKET SET
(Bravo Unit)**
Replaces: 16755A1, 16755Q1, 16755T1
For: All Bravo 



① 18-2617D 

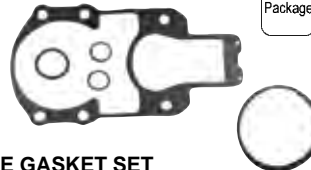

**18-2617
OUTDRIVE GASKET SET
Old Style**
Replaces: 27-35996A1
For: IA/IB/IC and EZ Shift (1964-1966)

—CONTAINS—

Part #	Description	O.E. #	Qty.
18-2820	Drive Shaft Housing to Bell Housing Gasket	27-64818	1
18-2840	Bell Housing Gasket	27-35982	1
18-7153	O-Ring	25-25439	2
18-7170	O-Ring	25-33504	1

—CONTAINS—

Part #	Description	O.E. #	Qty.
18-2516	Seal	16755	1
18-7198	O-Ring	25-45710	1
18-7153	O-Ring	25-25439	2
18-7168	O-Ring	25-48171	2
18-7105	O-Ring	25-62705	1
18-7117	O-Ring	25-35027	1

—CONTAINS—

Part #	Description	O.E. #
18-2556	Drive Shaft Housing to Bell Housing Gasket	27-35996
18-2840	Bell Housing Gasket	27-35982
18-7153	O-Ring	25-25439
18-7170	O-Ring	25-33504

① 18-2619-1D 



**18-2619-1
OUTDRIVE GASKET SET**
Replaces: 27-64818A3,
27-94996Q2, 27-94996T2
For: R, MR, Alpha I, Alpha Gen II (1983-Newer)

—CONTAINS—

Part #	Description	O.E. #
18-2743	Drive Shaft Housing to Bell Housing Gasket	27-94996-2
18-2840	Bell Housing Gasket	27-35982
18-7153	O-Ring	25-25439
18-7170	O-Ring	25-33504
18-7117	O-Ring	25-35027

**18-2620
OUTDRIVE GASKET SET**
Replaces: 27-54014A1, Q1
For: E, H, TR, TRS 



—CONTAINS—

Part #	Description	O.E. No.
18-7175	O-Ring	25-62817
18-2847	Drive Shaft Housing to Bell Housing Gasket	27-54014

① Items ending in "D" are Display Packaged - Regular number is Non-Display

Stern Drive Model	Beginning Serial No.	Ending Serial No.	Bell Housing Gasket	Bell Housing O-Ring	Bell Housing Rubber Gasket	U-Joint O-Ring (2 Required)	Gasket Set
I	1534570	1684187	—	18-7170	—	18-7153	—
IA	1684188	2062140	18-2556	18-7170	18-2840	18-7153	18-2617
IB	1684633	2062140	18-2556	18-7170	18-2840	18-7153	18-2617
IC	1685240	2065189	18-2556	18-7170	18-2840	18-7153	18-2617
II TR	3377316	4794899	18-2847	18-7175	—	—	18-2620
120	2062141	6225576	18-2820	18-7170	18-2840	18-7153	18-2614
120	6225577	UP	18-2743	18-7170	18-2840	18-7153	18-2619-1
120	6225577	UP	18-2743 ③	18-7170	18-2840	18-7153	18-2619-1
140	2062141	6225576	18-2820	18-7170	18-2840	18-7153	18-2614
140	6225577	UP	18-2743	18-7170	18-2840	18-7153	18-2619-1
140	6225577	UP	18-2743 ③	18-7170	18-2840	18-7153	18-2619-1
160	2065190	2763441	18-2820	18-7170	18-2840	18-7153	18-2614
165	2763442	UP	18-2820	18-7170	18-2840	18-7153	18-2614
170	6225577	UP	18-2743	18-7170	18-2840	18-7153	18-2619-1
170	6225577	UP	18-2743 ③	18-7170	18-2840	18-7153	18-2619-1
185	6225577	UP	18-2743	18-7170	18-2840	18-7153	18-2619-1
185	6225577	UP	18-2743 ③	18-7170	18-2840	18-7153	18-2619-1
190	6225577	UP	18-2743	18-7170	18-2840	18-7153	18-2619-1
190	6225577	UP	18-2743 ③	18-7170	18-2840	18-7153	18-2619-1
200	6225577	UP	18-2743	18-7170	18-2840	18-7153	18-2619-1
200	6225577	UP	18-2743 ③	18-7170	18-2840	18-7153	18-2619-1
215 E/H	2782203	2915034	18-2847	18-7175	—	18-7153 ①	18-2620
225	3856268	4200499	18-2820	18-7170	18-2840	18-7153	18-2614
228	4782330	6225576	18-2820	18-7170	18-2840	18-7153	18-2614
228	6225577	UP	18-2743	18-7170	18-2840	18-7153	18-2619-1
228	6225577	UP	18-2743 ③	18-7170	18-2840	18-7153	18-2619-1
230	6225577	UP	18-2743	18-7170	18-2840	18-7153	18-2619-1
230	6225577	UP	18-2743 ③	18-7170	18-2840	18-7153	18-2619-1
233	4200500	UP	18-2820	18-7170	18-2840	18-7153	18-2614
250	4791300	4898729	18-2820	18-7170	18-2840	18-7153	18-2614
255 TRS	3377316	4203749	18-2847	18-7175	—	—	18-2620
260	4898730	6225576	18-2820	18-7170	18-2840	18-7153	18-2614
260	6225577	UP	18-2743	18-7170	18-2840	18-7153	18-2619-1
260	6225577	UP	18-2743 ③	18-7170	18-2840	18-7153	18-2619-1
280 TRS	4203750	4895399	18-2847	18-7175	—	—	18-2620
470	4208730	6225576	18-2820	18-7170	18-2840	18-7153	18-2614
470	6225577	UP	18-2743	18-7170	18-2840	18-7153	18-2619-1
470	6225577	UP	18-2743 ③	18-7170	18-2840	18-7153	18-2619-1
485	4893835	UP	18-2820	18-7170	18-2840	18-7153	18-2614
488	6225577	UP	18-2743	18-7170	18-2840	18-7153	18-2619-1
488	6225577	UP	18-2743 ③	18-7170	18-2840	18-7153	18-2619-1
888	3106717	UP	18-2820	18-7170	18-2840	18-7153	18-2614
898	4782330	6225576	18-2820	18-7170	18-2840	18-7153	18-2614
898	6225577	UP	18-2743	18-7170	18-2840	18-7153	18-2619-1
898	6225577	UP	18-2743 ③	18-7170	18-2840	18-7153	18-2619-1
R/MR/Alpha One	6225577	UP	18-2743	18-7170	18-2840	18-7153	18-2619-1
R/MR/Alpha One	6225577	up	18-2743 ③	18-7170	18-2840	18-7153	18-2619-1
Bravo (I/II)	B664190	UP	18-2516	—	—	18-7153	18-2615
TR-TRS	4794900	UP	18-2847	18-7175	18-2847	18-7153 ②	18-2620

① Hydraulic Shift Only

② Borg Warner Transmission Only

③ For housing with oil reservoir check valve

ENGINE

DIAGNOSTICS = **STATS**

SIERRA TOUCH AND TEST SYSTEM

NEW NEW NEW NEW NEW NEW NEW NEW NEW NEW

00110011110011001100110 10101 01100



00110011110011001100110

10101 01100

00110011110011001100110 10101 01100

011000 0011 011 011 011 011 00

0101 0011 0111 00

IN+ENSIVE CARE FOR MULTIPLE ENGINES

STATS is a portable tool that provides full diagnostic, service and repair capability on the most popular makes and models of watercraft including, outboard, sterndrive, & inboard engines worldwide. Also includes PWCs.



SEASTAR SOLUTIONS®

www.sierrastats.com

Explore

formerly known as Teleflex Marine

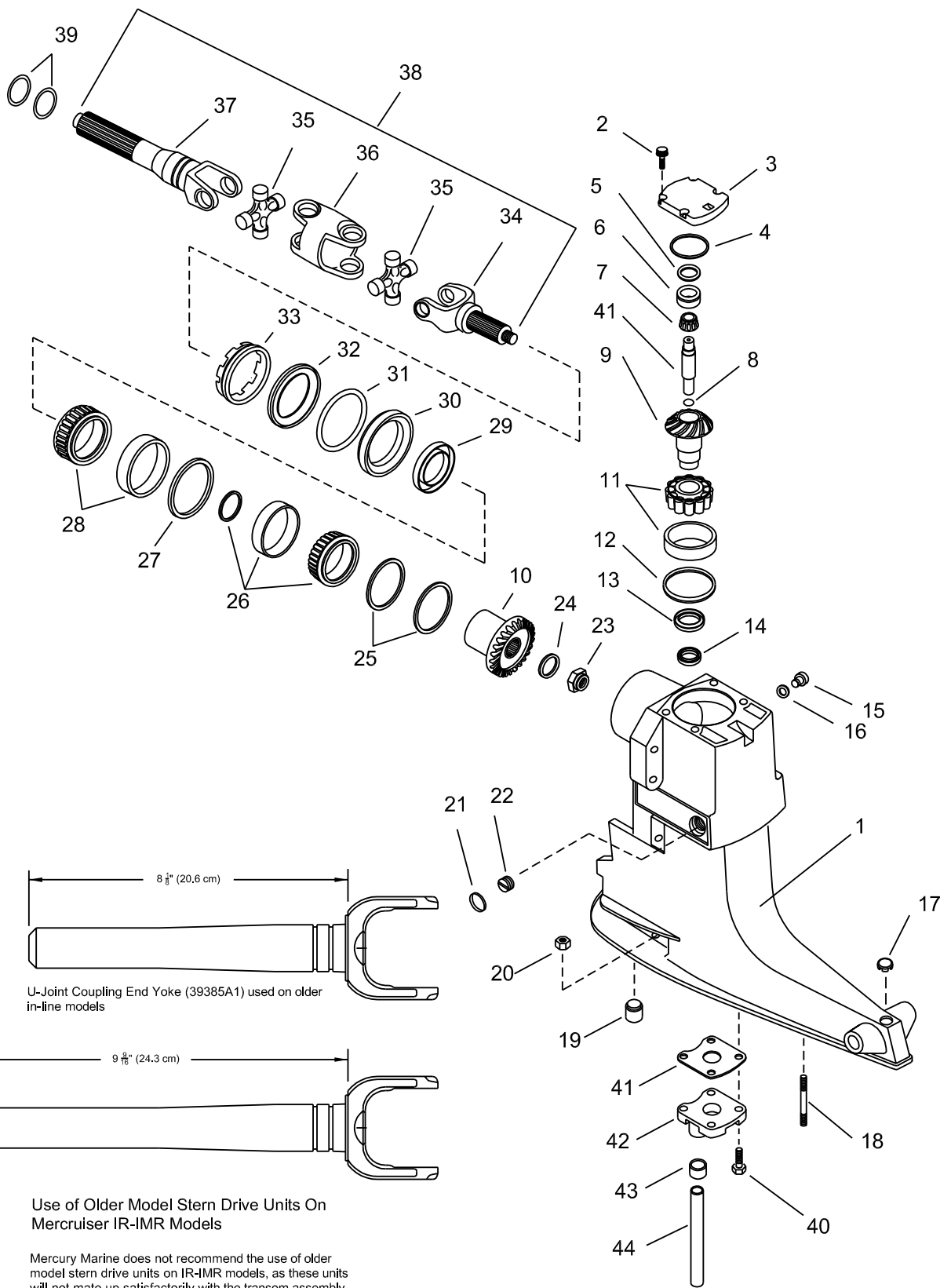

U-Joint Coupling End Yoke (39385A1) used on older in-line models

Use of Older Model Stern Drive Units On Mercuriser IR-IMR Models

Mercury Marine does not recommend the use of older model stern drive units on IR-IMR models, as these units will not mate up satisfactorily with the transom assembly. In addition, the older model in-line stern drive units are equipped with U-Joint coupling end yoke (39385A1). This yoke is shorter than yoke (59830A1) used on the IR-IMR stern drive units, and therefore, will not fully engage the engine coupler splines. **Use of an older In-Line model stern drive unit on a IR-IMR model will result in a spline failure to coupling and/or yoke.**

Figure #	Description	Part #	O.E.M. #	Qty.
1	Upper Gear Housing	N/A	1547-9412A18	1
2	Screw, Top Cover	18-3231	10-98794	4
3	Top Cover	18-2381	94998A2	1
4	O-Ring, Top Cover	18-7161	25-32546	1
5	Shim, Bearing Cup to Top Cover	18-2283	15-45691A1	1
6	Tapered Roller Bearing	18-1165	31-61100A1	1
7	Upper Drive Shaft	18-2179	45-55796	1
8	O-Ring, Upper Drive Shaft	18-7445	25-55801	1
9./10.	Upper Unit Gear Set			
	1.5:1	18-2201	43-18410A2, 46-18411A2	1
	Rebuild Kit	18-2256	43-803116T1	1
	1.65:1	18-2203	43-45814A5	1
	Rebuild Kit	18-2257	43-803112T1	1
	1.84:1	18-2204	43-75325A3	1
	Rebuild Kit	18-2258	43-803114T1	1
	1.98:1	18-2205	43-55778A3	1
	Rebuild Kit	18-2259	43-803101T1	1
11	Tapered Roller Bearing	18-1161	31-35990A1	1
12	Shim Kit, Bearing Cup to Drive Shaft Housing	18-2293	15-36178A1	1
13	Oil Seal, Upper Drive Shaft Housing	18-2049	26-32511	1
14	Oil Seal, Lower Drive Shaft Housing	18-2056	26-96503	1
15	Vent Screw	18-2244	10-79953A2	1
16	Gasket, Gear Housing Drain Screw	18-2945	12-19183, 12-20260	1
17	Plug, Trim Tab Hole	18-3232	19-47579	1
18	Stud, Drive Shaft Housing	N/A	16-56295	2
19	Bushing, Drive Shaft Housing	18-3236	23-32632	1
20	Nut, Gear Housing Stud	18-2362	11-13439-1	3
21	Welch Plug, Drive Shaft Housing			
	(7/8" OD)	18-4272	19-32652	1
	(1 1/4" OD)	18-4273	19-42682	1
22	Pipe Plug, Water Pocket	18-4265	22-428611	1
23	Nut, Drive Gear to U-Joint	18-3713	11-22339	1
24	Washer, Drive Gear to U-Joint Nut	18-3712	12-45810	1
25	Shim Kit Drive Gear	18-2292	15-35980A1	1
26	Bearing Kit	18-1160	31-35988A2, A12	1
27	Spacer (comes with kit)	18-1160	31-35988A2, A13	1
28	Roller Bearing (comes with kit)	18-1160	31-35988A2, A13	1
29	Oil Seal	18-2003	26-64893	1
30	Carrier Assembly Oil Seal	18-0577	66081A2	1
31	O-Ring	18-7169	25-70937	1
32	Ring, Roller Bearing Retainer	18-4296	35983	1
33	Retaining Nut Drive Shaft Housing	18-3752	816811-1	1
34	Yoke Assembly	18-2125	46020T	1
35	Heavy Duty U-Joint	18-2104	75832A2	1
36	Center Socket	18-2128	39383T	1
37	U-Joint Shaft Coupler	18-2146	59830A1	1
38	Drive Shaft	18-9218	59830A5	1
39	O-Ring	18-7153	25-25439	2
40	Screw, Water Pocket Cover to Drive Shaft Housing	18-3229	10-28668	4
41	Gasket, Water Pocket Cover	18-0894	27-55810	1
42	Water Pocket Cover (Sold as Assembly includes 40-44)	18-3219	42724A3	1
43	Bushing, Water Pump Housing	18-3110	26-38970	1
44	Water Tube	18-3220	32-54236	1

AR As required

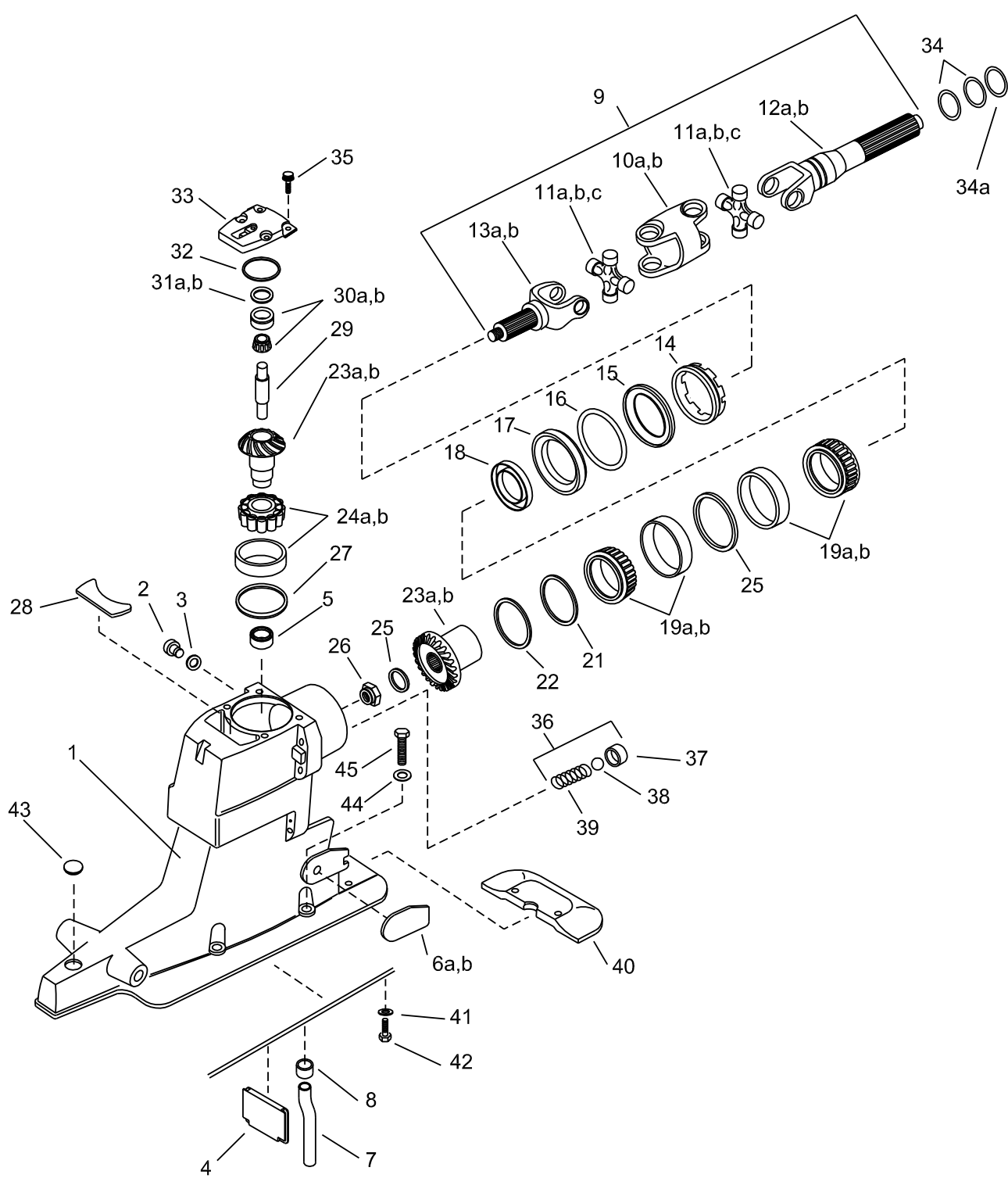

SEE PAGES 708-710 FOR COMPLETE REPLACEMENT HOUSINGS

Figure #	Description	Part #	O.E.M. #	Qty.	Figure #	Description	Part #	O.E.M. #	Qty.
1	Drive Shaft Housing (OL100009 & UP)	18-2411	1547-861063A 4	1		Complete Service Kit	18-2364	43-803119T 1	1
						1.84:1/ 1.81:1 Gear Set (tooth count... 17/19)	18-2204	43-75325A3	1
2	Screw	18-2244	10-79953A2	1					
3	Washer	18-2945	12-19183, 12-20260	1		Std. Rebuild Kit	18-2258	43-803114T 1	1
						Complete Service Kit	18-2365	43-803120 T 1	1
4	Filler Wall	N/A	815932	1					
5	Oil Seal	18-2056	26-66302	AR		1.98:1/ 1.94:1 Gear Set (tooth count... 20/24)	18-2205	43-55778A3	1
6a	Wear Pad (Port)	NSS	814386	1		Std. Rebuild Kit	18-2259	43-803101T 1	1
6b	Wear Pad (Stbd)	NSS	814387	1		Complete Service Kit	18-2363	43-803118T 1	1
7	Water Tube	18-3221	32-860220	1	23a	Upper Unit Gear Set (OL100009 & UP)			
8	Seal	NSS	26-88397	1					
9	Yoke Assembly (OK999999 & Below)	18-9218	814819A2	1		1.47:1 Gear Set (tooth count... 20/22)	18-6351	43-853641A2	1
						Complete Service Kit	18-6351K	43-803103T 1	1
	Yoke Assembly (OL100009 & UP)	18-6402	864281A2	1					
10a	Socket, Center (old design)	18-2097	39383T	1		1.62:1 & 2.0:1 Gear Set (tooth count... 24/24)	18-6350	43-853640A2	1
10b	Socket, Center GKN Series	NSS	865503T	1					
11	Cross and Bearing					Complete Service Kit	18-6350K	43-803104T 1	1
11a	D469859 - F679999 (old design)	18-2174	75832A2	2		1.81:1 Gear Set (tooth count... 17/19)	18-6353	43-853643A2	1
11b	F680000- OK999999 (old design- permalube)	18-2097	805536A2	2		Complete Service Kit	18-6353K	43-803105T 1	1
11c	OL100009 & UP (GKN Series)	18-6406	865493A01	2		1.94 & 2.4:1 Gear Set (tooth count... 20/24)	18-6352	43-853642A2	1
12a	Yoke, Coupling End (OK999999 & Below)	18-2146	59830A1	1		Complete Service Kit	18-6352K	43-803106T 1	1
12b	Yoke, Coupling End (OL100009 & UP)	18-6405	865491A01	1	24	Roller Bearing (All but 1.47:1 ratio)	18-1161	43-803106T 1	1
					24a	Roller Bearing (1.47:1 Ratio only)	18-1142	31-32573A 1	1
13a	Yoke, Gear End (OK999999 & Below)	18-2125	46020T	1	25	Washer	18-3712	12-45810	1
					26	Nut	18-3713	11-22339	1
13b	Yoke, Gear End (OL100009 & UP)	18-6403	865492T	1	27	Shim Kit	18-2293	15-36178A1	1
14	Retaining Nut	18-3752	816811-1	1	28	Plug	NSS	861738	1
15	Ring	18-4296	35983	1	29	Drive Shaft, Upper (F680000 & Up)	18-2324	45-55796-1	1
16	O-Ring	18-7169	25-70937	1	30	Bearing Assembly			
17	Carrier Assembly (Set)	18-0577	66081A2	1	30a	F680000 & UP (small bearing)	18-1179	31-32575A1	1
18	Oil Seal	18-2003	26-68493	1	30b	D494569 - F679999 (large bearing)	18-1165	31-61100A1	1
19	Roller Bearing Kit (D469859 - K999999)	18-1160	31-35988A2, A12	1	31	Shim Kit			
					31a	D494569 -F679999	18-2283	15-45691A1	1
19a	Roller Bearing Kit (OL100009 & UP)	18-1182	31-30894A 15	1	31b	F680000 & UP	18-2282	15-32563A1	1
					32	O-Ring	18-7161	25-32546	1
20	Cup Spacer (Included with 18-1160)	18-1160	31-35988A2, A12	AR	33	Cover Assembly, Top (F680000 & Up)	18-2382	828692A1	1
20a	Cup Spacer (Included with 18-1182)	NSS	23-853649A 1	AR	34	O-Ring	18-7153	25-25439	2
					34a	O-Ring	18-7117	25-35027	1
21	Shim Kit	18-2292	15-35980A1	1	35	Screw	18-3231	10-98794	4
22	Shim Spacer	18-2296	15-71013	1	36	Check Valve Kit, Oil Passage	18-2715 KIT	24-17997A1	1
23	Upper Unit Gear Set (OD469859-OK999999)				37	Oil Seal (Included in Kit)	NSS	—	1
					38	Ball (Included in Kit)	NSS	—	1
	1.5:1/ 1.47:1 Gear Set (tooth count... 20/22)	18-2201	43-18410A2, 43-18411A2	1	39	Spring	NSS	—	1
	Std.Rebuild Kit	18-2256	43-803116T 1	1	40	Anode Plate	18-6080	821629A1	1
	Complete Service Kit	18-2358	43-803102T 1	1	41	Lockwasher	N/A	13-78968	2
	1.65:1/ 1.62:1 Gear Set (tooth count... 24/24)	18-2203	43-45814A5	1	42	Screw	18-3229	10-28668	2
	Std. Rebuild Kit	18-2257	43-803112T 1	1	43	Plug	N/A	19-824928	1
					44	Washer	18-4858-9	12-45176	4
					45	Bolt	18-3230	10-816601	4

AR As required

NSS Not Sold Separate

N/A Not Available

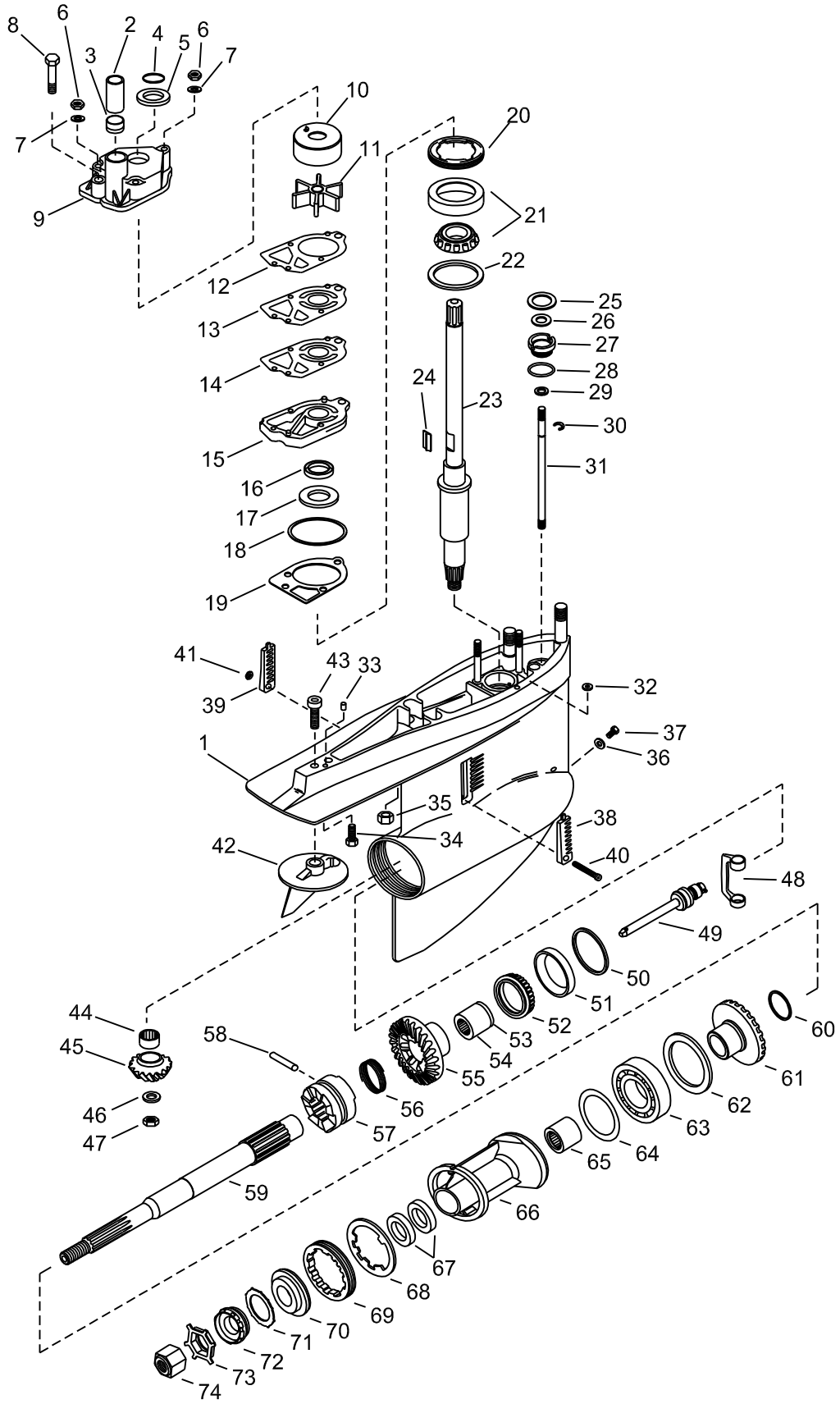

SEE PAGES 708-710 FOR COMPLETE REPLACEMENT HOUSINGS

Figure #	Description	Part #	O.E.M. #	Qty.	Figure #	Description	Part #	O.E.M. #	Qty.
1	Gear Housing	18-2401	1623-8951A37	1	44	Pinion Bearing	18-1117	31-42647A1	1
2	Water Tube Guide	18-3109	23-29804	1	45	Lower Alpha Gear Set (pinion gear)	18-2206	43-17064A2, 43-17064A3, 43-42934	1
3	Bushing/Water Pump Housing	18-3110	26-38970	1					
4	O-Ring, Upper Drive Shaft	18-7158	25-30613	1					
5	Slinger	18-7426	25-30271	1	46	Anti-Galling Washer Pinion Gear	18-2343	22-92721	1
6	Stainless Steel Locknuts (5/16-24)	N/A	11-13436	1	47	Pinion Nut	18-3719	11-35921	1
	Stainless Steel Locknuts (1/4-28)	N/A	11-13438	2	48	Shift Crank	18-2130	76865	1
7	Washer	18-4270	12-36001	3	49	Shift Spool Assembly	18-2286	818349A1	1
8	Screw, Water Pump Body to Water Pump Base	N/A	10-96411	1	50	Shim Kit, Forward Gear	18-2285	15-47397A1	1
					51	Tapered Roller Bearing Set	18-1159	31-35928A1	1
9	Upper Pump Housing	18-3116	46-96148A1	1	52	Inner Bearing, Forward Gear	18-1157	31-30895	1
10	Insert Cup	18-3114	48752	1	53	Retaining Clip, Inner Bearing	N/A	—	1
11	Impeller	18-3017	47-89984	1	54		18-1157	31-30895	1
12	Gasket, Upper Water Pump to Wear Plate	18-2915	27-85609-1	1	55	Lower Alpha Gear Set (Forward Gear/Pinion)	18-2206	43-17064A2, 43-17064A3, 43-42934	1
13	Impeller Plate	18-3117	32435	1					
14	Gasket, Wear Plate to Water Pump Base	18-2914	27-85608-1	1					
15	Water Pump Base	18-3420	46-44292A3	1	56	Spring, Retainer - Cross Pin	18-2348	24-30893	1
					57	Sliding Clutch	18-2202	52-66063	1
16	Oil Seal (upper)	18-2013	26-16977	1	58	Cross Pin, Clutch to Actuating Shaft	18-2357	24-30893	1
17	Oil Seal (lower)	18-2014	26-89238	1					
18	O-Ring, Water Pump	18-7176	25-90011	1	59	Propeller Shaft	18-2166	44-66060, 44-6606-3	1
19	Gasket, Water Pump Base to Gear Housing	18-2919	27-42631-1	1	60	Spacer, Reverse Gear	N/A	23-824108	1
20	Retainer, Drive Shaft Bearing	18-2346	824519	1	61	Lower Alpha Gear Set (Reverse Gea-NSS)	18-2206	43-17064A2, 43-17064A3, 43-42934	1
21	Tapered Roller Bearing Drive Shaft	18-1143	31-36387A1	1					
22	Shim Kit, Lower Drive Shaft Bearing	18-2294	15-42637A1	1	62	Thrust Ring, Bearing Carrier	18-2342	68100-1	1
23	Drive Shaft	18-2180	45-42634	1	63	Ball Bearing	18-1155	30-88957A1	1
24	Drive Key Water Pump Impeller	N/A	28-56654	1	64	O-Ring, Bearing Carrier	18-7159	25-31534	1
25	Shift Shaft Washer	18-4267	12-29395	1	65	Needle Roller Bearing	18-1158	31-30956	1
26	Washer Rubber Shift Shaft Bushing	18-2340	12-31266	1	66	Bearing Carrier	18-2191	73020A-14	1
27	Shift Bushing	18-2154	23-30617A2	1	67	Oil Seals, Bearing Carrier	18-2002	26-76868	2
28	O-Ring, Shift Shaft Bushing	18-7153	25-25439	1	68	Tab Washer	18-2298	14-18323	1
29	Washer, Lower Shift Shaft	NSS	12-27880	1	69	Spanner Nut	18-3751	79448	1
30	Retaining Clip, Shift Shaft	NSS	53-29641	1	70	Thrust Washer	18-4220	13171, 77987	1
31	Stainless Steel Shift Shaft	18-2150	77481-1	1	71	Continuity Washer	N/A	13-423511	1
32	Oil Passage Seal	18-2944	26-45577	1	72	Brass Castle Washer	18-3714	12-31211A2	1
33	Dowel Pin, Gear Housing to Drive Shaft Housing	18-3226	10-30720	2	73	Tab Washer	18-3200	14-31210, 14-816629	1
34	Screw, Gear Housing to Drive Shaft Housing	18-2361	10-30206	1					
35	Nut, Gear Housing to Drive Shaft Housing	18-2362	11-13439-1	2					
36	Gasket, Gear Housing Drain Screw	18-2945	12-19183, 12-20260	1					
37	Plug, Oil Fill/Drain	18-2244	10-79953A2	1					
38	Insert, Water Pick (Stbd)	18-3199	93423-1	1					
39	Insert, Water Pick (Port)	118-3198	93424-1	1					
40	Screw, Insert to Gear Housing	18-3197	10-76156	1					
41	Nut, Insert Screw	18-2344	11-45812	1					
42	Trim Tab	18-6011	31640A1	1					
43	Screw, Trim Tab Gear Housing	18-6245	10-32470	1					

N/A Not Available

NSS Not Sold Separate

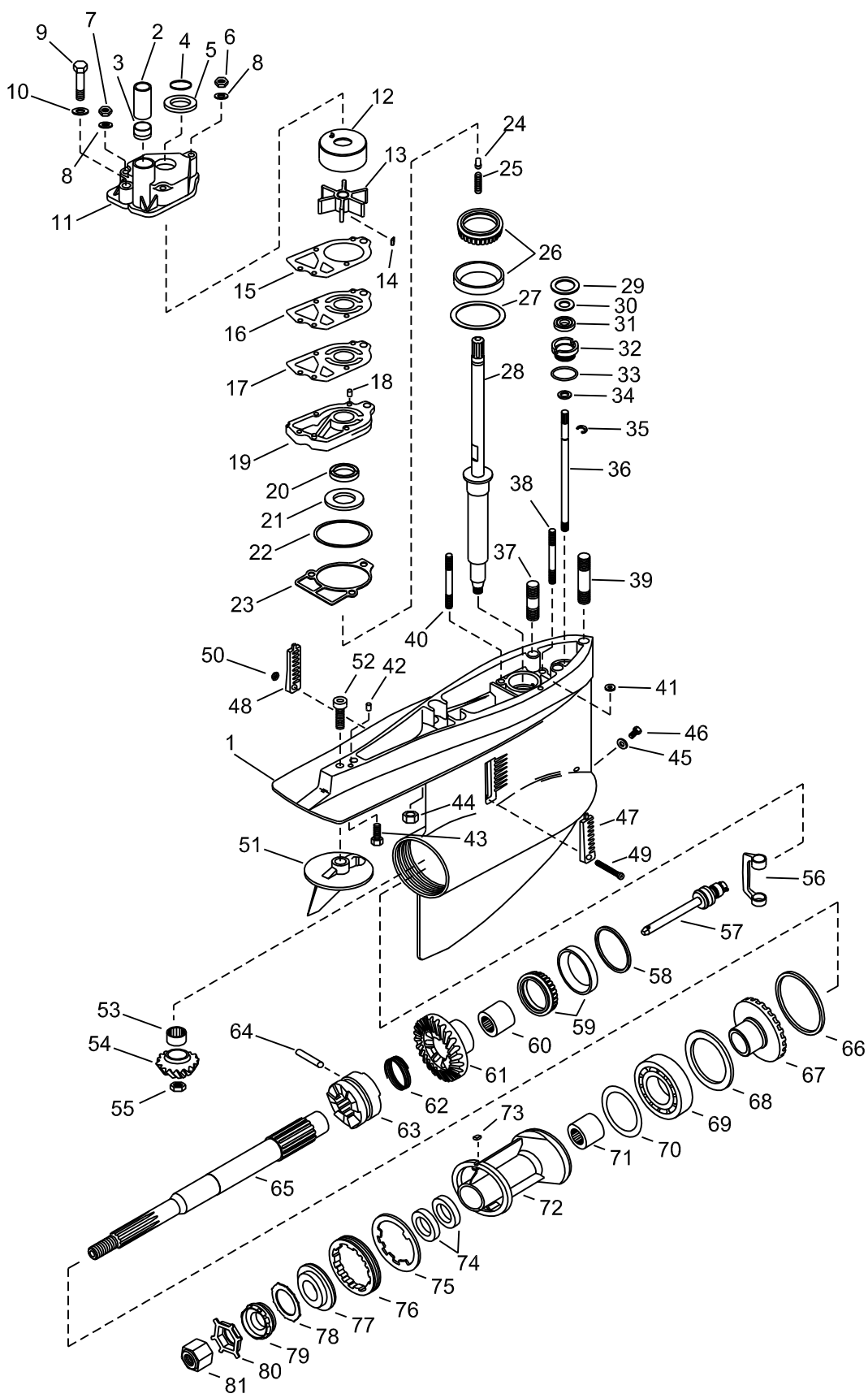

SEE PAGES 708-710 FOR COMPLETE REPLACEMENT HOUSINGS

Figure #	Description	Part #	O.E.M. #	Qty.	Figure #	Description	Part #	O.E.M. #	Qty.
1	Lower Gear Housing	18-2402	1623-5356A4	1	43	Screw, Gear Housing to Drive Shaft Housing	18-2361	10-30206	1
2	Water Tube Guide	18-3109	23-29804	1	44	Nut Gear Housing to Drive Shaft Housing	N/A	11-82671015	2
3	Bush Water Pump Housing	18-3110	26-38970	1	45	Gasket, Gear Housing Drain Screw	18-2945	12-19183, 12-20260	1
4	O-Ring, Upper - Drive Shaft	18-7158	25-30613	1	46	Plug, Oil Fill/Drain	18-2244	10-79953A2	1
5	Slinger	18-7426	25-30271	1	47	Insert, Water Pick (Stbd)	N/A	66885	1
6	Stainless Steel Locknuts (5/16-24)	18-3723	11-45592	1	48	Insert, Water Pick (Port)	N/A	66884	1
7	Stainless Steel Locknuts (1/4-28)	18-3722	11-20361, 11-35888	2	49	Screw Insert to Gear Housing	18-3197	10-76156	1
8	Washer	18-4275	12-29245	3	50	Nut, Insert Screw	18-2344	11-45812	1
9	Screw	18-3226	10-30720	1	51	Trim Tab	18-6011	31640A1	1
10	Washer, Water Pump Body	18-4270	12-36001	1	52	Screw, Trim Tab to Gear Housing	18-6245	10-32470	1
11	Upper Pump Housing	18-3116	46-96148A1	1	53	Needle Roller Bearing	18-1150	31-92366A1	1
12	Insert Cup	18-3114	48752	1	54	Lower Unit Gear Set (pinion gear)	18-2200	23-96084A4	1
13	Impeller	18-3017	47-89984	1	55	Pinion Nut	18-3719	11-35921	1
14	Drive Key	N/A	28-56654	1	56	Shift Crank	18-2130	76865	1
15	Gasket, Upper Water Pump to Wear Plate (upper)	18-2915	27-85609-1	1	57	Shift Spool Assembly	19755A2	18-2286	1
16	Impeller Plate	18-3117	32435	1	58	Shim Kit, Forward Gear Bearing	18-2285	15-47397A1	1
17	Gasket, Upper Water Pump to Wear Plate (lower)	18-2914	27-85608-1	1	59	Tapered Roller Bearing	18-1159	31-35928A1	1
18	Dowel Pin	18-3227	17-35973	2	60	Needle Roller Bearing	18-1157	31-30895	1
19	Water Pump Base	18-3417	46-57234A1	1	61	Lower Unit Gear Set (Forward)	18-2200	23-96084A4	1
20	Oil Seal (upper)	18-2026	26-16977	1	62	Spring, Retainer, Cross Pin	18-2348	24-30893	1
21	Oil Seal (lower)	18-2014	26-89238	1	63	Sliding Clutch	18-2202	52-66063	1
22	O-Ring (2.175 ID) & (2.1091 ID)	18-7176, 18-7196	25-90011	1	64	Cross Pin, Clutch to Clutch Actuating Shaft	18-2348	17-30632	1
23	Gasket, Water Pump Base to Gear Housing	18-2826	27-85610-1	1	65	Propeller Shaft	18-2166	44-66060, 44-66060-3	1
24	Pin, Driveshaft	N/A	17-30545	1	66	Shim Kit, Thrust Ring to Gear Housing	18-2284	15-31535A1	1
25	Spring	N/A	24-34576	1	67	Lower Unit Gear Set (reverse)	18-2200	43-96084A4	1
26	Tapered Roller Bearing	18-1164	31-53079A1	1	68	Thrust Ring, Bearing Carrier	18-3759	35915	1
27	Shim Kit, Drive Shaft Bearing	18-2295	15-57007A	1	69	Ball Bearing	18-1155	30-88957A1	1
28	Drive Shaft	18-2167	45-41939A1	1	70	O-Ring	18-7159	25-31534	1
29	Shift Shaft Washer	18-4267	12-29395	1	71	Needle Roller Bearing	18-1158	31-30956	1
30	Washer, Rubber Shift Shaft Bushing	18-2340	12-31266	1	72	Bearing Carrier Assembly	18-2191	73020A14	1
31	Oil Seal	26-89236	18-2009	1	73	Key, Locating - Bearing Carrier	N/A	28-30281	1
32	Shift Bushing	18-2154	23-30617A2	1	74	Oil Seals	18-2002	26-76868	2
33	O-Ring	18-7153	25-25439	1	75	Tab Washer	18-2299	14-79447	1
34	Washer, Lower Shift Shaft Bushing	N/A	12-27880	1	76	Spanner Nut	18-3751	79448	1
35	Retaining Clip, Shift Shaft	18-4295	53-29641	1	77	Thrust Washer	18-4220	13171, 77987	1
36	Stainless Steel Shift Shaft	18-2150	77481-1	1	78	Continuity Washer	NSS	13-423511	1
37	Stud, Gear Housing to Drive Shaft Housing (1-31/32")	N/A	16-56298	2	79	Brass Castle Washer	18-3714	12-31211A2	1
38	Stud, Water Pump to Gear Housing (3 - 3/8")	N/A	16-562972	1	80	Tab Washer	18-3200	14-31210, 14-816629	1
39	Stud, Gear Housing to Drive Shaft Housing (3 - 3/16")	N/A	16-46911	1	81	Prop Nut	18-3700	11-52707	1
40	Stud, Water Pump to Gear Housing (3 - 1/4")	N/A	16-69501	2					
41	Oil Passage Seal	18-2944	26-45577	1					
42	Dowel Pin, Gear Housing to Drive Shaft Housing	N/A	17-35973	2					

AR As required

NSS Not Sold Separate

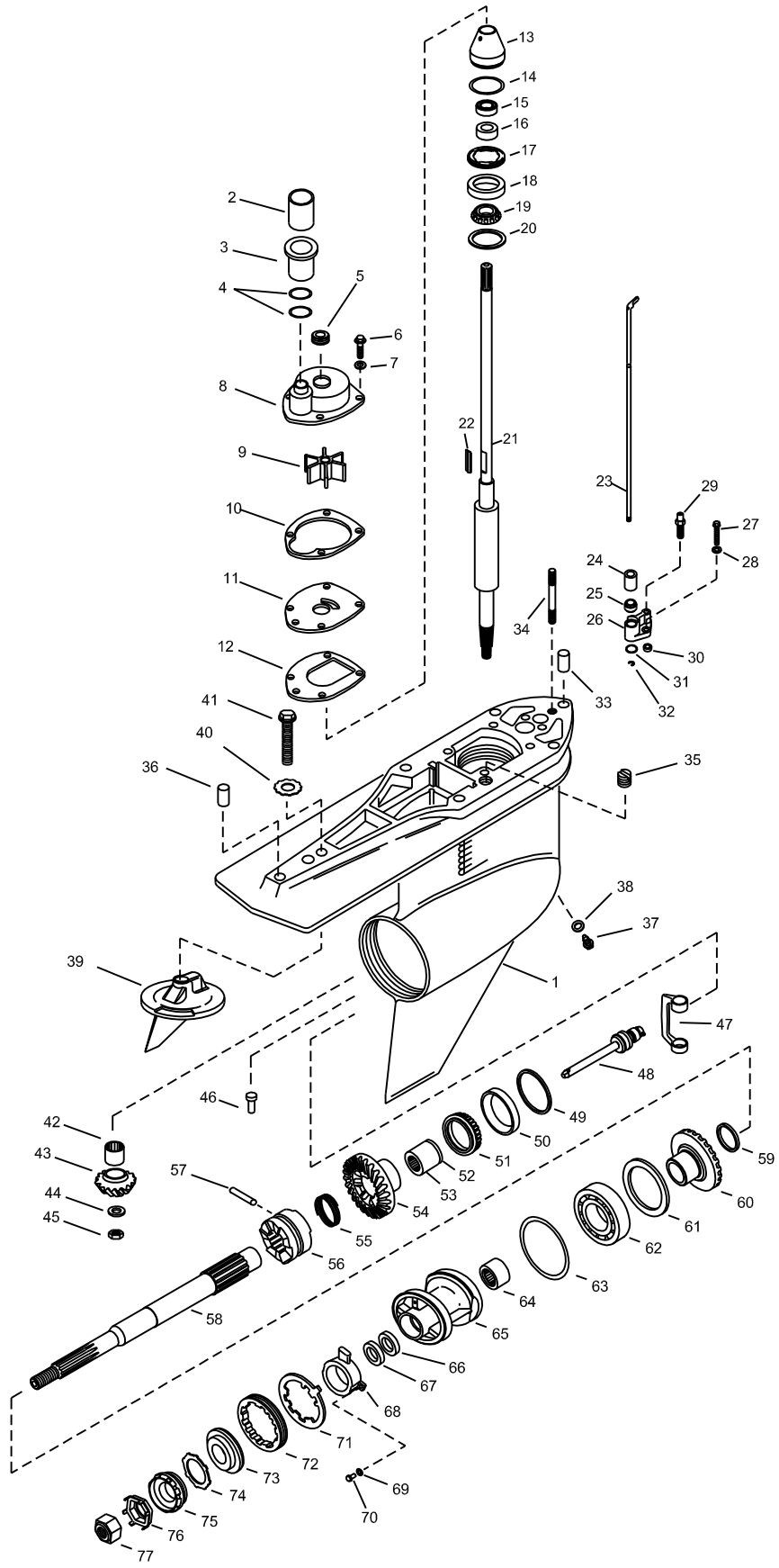

SEE PAGES 708-710 FOR COMPLETE REPLACEMENT HOUSINGS

Figure #	Description	Part #	O.E.M. #	Qty.	Figure #	Description	Part #	O.E.M. #	Qty.
1	Gear Housing	18-2415	1623-815822A36	1	48	Shift Spool Assembly	18-2286	818349A1	1
2	Sleeve	—	23-816573	1	49	Shim Kit	18-2285	15-47397A1	1
3	Coupling	18-3151	816597A1	1	50 & 51	Forward Gear, Outer Bearing	18-1159	31-35928A1	1
4	O-Rings	18-7420	25-21836	2	52	Retaining Clip, Inner Bearing	NSS	—	1
5	Face Seal	18-2599	26-816575A2	1	53	Forward Gear, Inner Bearing	18-1157	31-30895	1
6	Screw, 10-32 X 5/8	NSS	10-806290	4	54	Forward Gear	18-2206	43-828072A2	1
7	Star Washer	NSS	13-69432	4	55	Cross Pin Spring	18-2348	24-30893	1
8	Water Pump Body	18-3147	817275A1	1	56	Sliding Clutch	18-2202	52-824112	1
9	Impeller	18-3056	47-43026-2	1	57	Cross Pin	18-2357	17-30632	1
10	Gasket	18-2563	27-817277	1	58	Propeller Shaft	18-2166	44-824110	1
11	Face Plate	18-3122	817276	1	59	Spacer	—	23-824108	1
12	Gasket	18-2564	27-43033-1	1	60	Reverse Gear	18-2206	43-828072A2	1
13	Seal Carrier	18-2354	821759A2	1	61	Thrust Ring	18-2342	681001	1
14	O-Ring	18-7176	25-90011	1	62	Ball Bearing	18-1155	30-88957A1	1
15	Seal	18-2013	26-16977	1	63	O-Ring	18-7159	25-31534	1
16	Seal	18-2014	26-89238	1	64	Roller Bearing	18-1158	31-30956	1
17	Cover Nut	18-2346	824519	1	65	Bearing Carrier	18-2376	818763A10	1
18 & 19	Bearing, Upper Driveshaft (1.50-1.65 Ratio)	18-1143	31-36387A1	1	66	Seal	18-2002	26-14077	1
					67	Seal	18-2076	26-12224	1
	Bearing, Upper Driveshaft (1.47-1.62 Ratio)	18-1193	31-33138A1	1	68	Carrier Anode	18-6093	806105A1	1
					69	Lockwasher, Anode Mounting	—	13-69432	2
20	Shim Kit	18-2294	15-42637A1	1	70	Bolt, Anode Mounting	—	10-806290	2
21	Drive Shaft (1:47 & 1:62)	18-2331	45-853648	1	71	Tab Washer	18-2298	14-18323	1
					72	Cover Nut	18-3751	79448	1
	Drive Shaft (1:50 & 1:65)	18-2261	45-816919	1	73	Thrust Hub	18-4220	13171	1
					74	Continuity Washer	NSS	13-42351-1	1
22	Impeller Drive Key	18-3293	28-43037	1	75	Splined Washer	18-3714	12-31211A2	1
23	Shift Shaft	18-2320	815919A1	1	76	Tab Washer	18-3200	14-31210	1
24	Sleeve	18-2349	23-67370	1	77	Propeller Nut	18-3700	11-52707	1
25	Seal	18-2009	26-89236	1		Seal Kit (Not Pictured)	18-2646-1	26-816575A3	1
26	Shift Rod Bushing Assembly	18-2353	23-815921A21	1					
27	Screw, 10-32 X 5/8	NSS	10-806290	2					
28	Star Washer	NSS	13-69432	2					
29	Speedometer Pickup Fitting	—	NSS	1					
30	O-Ring	18-7440-1	25-36318	1					
31	O-Ring	18-7440-1	25-36318	1					
32	Retaining Ring	18-4295	53-29641	1					
33	Dowel Pin	—	17-43044	1					
34	Stud, Mounting	—	16-57984	1					
35	Seal	18-2944	26-45577	1					
36	Dowel Pin	—	17-43044	1					
37	Plug	18-2375	22-67892A1	1					
38	Gasket	18-2945	12-19183	1					
39	Trim Tab	18-6016	76214A5	1					
40	Washer, Anode Mounting	—	13-806210	1					
41	Bolt, Anode Mounting	—	10-806327	1					
42	Pinion Bearing	18-1117	31-42647A1	1					
43	Pinion Gear	18-2206	43-828072A2	1					
44	Washer	18-2343	12-92721	1					
45	Nut	18-3719	11-35921	1					
46	Pin	—	17-37972-1	1					
47	Shift Crank	18-2130	76865	1					

NSS Not Sold Seperate



18-2292 SHIM KIT
 Drive Gear
 Replaces: 15-35980A1
 Contains (1) each
 .002, .003, .005, .006, .010, .025
 For: Mercuriser Vazer



18-2293 SHIM KIT
 Upper Bearing
 Replaces: 15-36178A1
 Contains (1) each .002, .003, .015
 (2) each .010
 For: Mercuriser Vazer

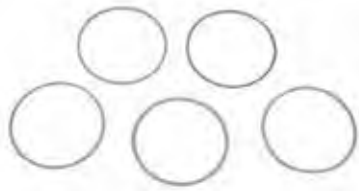

18-2294 SHIM KIT
 Lower Drive Shaft Bearing
 Replaces: 15-8M0063267, 15-42637A1
 Contains (1) each
 .002, .003, .005, .010, .020
 For: Mercuriser Vazer



18-2295 SHIM KIT
 Lower Drive Shaft Bearing
 Replaces: 15-57007A1
 Contains (1) each
 .002, .003, .005, .010, .020
 For: Mercuriser Vazer

SHIMS

Part #	Size	O.E. #
* 18-2282	Kit	15-32563A1 For: Mercuriser Vazer
* 18-2283	Kit	15-45691A1
* 18-2284	Kit	15-31535A1
* 18-2285	Kit	15-47397A1
18-2296	.055	15-71013



- * **18-2282** (1) each .002, .003, .005, .010, .025
- * **18-2283** (1) each .002, .003, .005, .010
- * **18-2284** (1) each .002, .003, .005, .010, .020
- * **18-2285** (1) each .002, .003, .005, .010, .020

SHIM KIT APPLICATION

HP	Serial Number	Bearing to Top Cover Kit	Bearing Cup to Drive Shaft Housing	Drive Gear	Drive Gear Spacer	Drive Shaft Bearing to Gear Housing	Reverse Gear	Forward Gear Kit
120/140	2062141 thru 2791956	18-2282 ②	18-2293	18-2292	18-2296	18-2295	18-2284 ⑤	18-2285
120/140	2791957 thru 4893634	18-2283 ④	18-2293	18-2292	18-2296	18-2295	18-2284 ⑤	18-2285
120/140	4893635 thru 6225576	18-2283	18-2293	18-2292	18-2296	18-2295	—	18-2285
160	2065190 thru 2763441	18-2282 ②	18-2293	18-2292	18-2296	18-2295	18-2284 ⑤	18-2285
165	2763442 thru 4890459	18-2283 ④	18-2293	18-2292	18-2296	18-2295	18-2284 ⑤	18-2285
165	4890460 & UP	18-2283	18-2293	18-2292	18-2296	18-2295	—	18-2285
888	3106717 & UP	18-2283 ③	18-2293	18-2292	18-2296	18-2295	18-2284 ⑤	18-2285
898/228	4782330 thru 4898729	18-2283	18-2293	18-2292	18-2296	18-2295	18-2284 ⑤	18-2285
898/228	4898730 thru 6225576	18-2283	18-2293	18-2292	18-2296	18-2295	—	18-2285
225-S	3856268 thru 4200499	18-2283	18-2293	18-2292	18-2296	18-2295	18-2284 ⑤	18-2285
233	4200500 & UP	18-2283	18-2293	18-2292	18-2296	18-2295	18-2284 ⑤	18-2285
250	4791300 thru 4898729	18-2283	18-2293	18-2292	18-2296	18-2295	18-2284 ⑤	18-2285
260	4898730 thru 6225576	18-2283	18-2293	18-2292	18-2296	18-2295	—	18-2285
470	4208730 thru 4893934	18-2283	18-2293	18-2292	18-2296	18-2295	18-2284 ⑤	18-2285
470	4893835 thru 6225576	18-2283	18-2293	18-2292	18-2296	18-2295	—	18-2285
485	4893835 & UP	18-2283	18-2293	18-2292	18-2296	18-2295	—	18-2285
R/MR/Alpha One	6225577 & UP (R)	18-2283	18-2293	18-2292	18-2296	18-2295	—	18-2285
R/MR/Alpha One	6225577 & UP (MR)	18-2283	18-2293	18-2292	18-2296	18-2294	① ⑥	18-2285
Alpha Gen II	D494569 thru F679999	18-2283	18-2293	18-2292	18-2296	18-2294	① ⑥	18-2285
Alpha Gen II	F680000 & UP	18-2282		18-2293	18-2292	18-2296	18-2294① ⑥	—

- ① For .208" Shim use Part Number 18-0208
- ① For .210" Shim use Part Number 18-0210
- ① For .212" Shim use Part Number 18-0212
- ① For .214" Shim use Part Number 18-0214
- ① For .218" Shim use Part Number 18-0218

- ① For .220" Shim use Part Number 18-0220
- ① For .222" Shim use Part Number 18-0222
- ① For .224" Shim use Part Number 18-0224
- ① For .226" Shim use Part Number 18-0226

- ② S/N #2187468 & Below use 18-2293
- ③ S/N #4433200 & UP Only
- ④ S/N #4530702 & UP Only
- ⑤ Kit
- ⑥ For Counter Rotation Only



18-2400 COMPLETE LOWER GEAR CASE
 Replaces: 1623-815822A53
 For: Ratios 1.47, 1.62, 1.81 & 1.94
 Fits: Gen II (1998 & up) 0L100040 & up



18-2411 DRIVE SHAFT HOUSING ASSEMBLY
 Replaces: 1547-861063A4
 For: Gen II Upper (1998-up), 0L100040-up, 1.47:1 Ratio/Gen II Upper (1998-up) 0L100040-up, 1.62/2.00:1 Ratio's/Gen II Upper (1998-up), 0L100040-up, 1.81:1 Ratio/Gen II Upper (1998-up), 0L100040-up, 1.94/2.40:1 Ratios
 Used with: 18-2416, 18-2417, 18-2418, 18-2419 Complete Upper Gear Cases



18-2415
GEAR HOUSING ASSEMBLY
 Replaces: 1623-815822A36
 For: Ratios 1.47, 1.62
 Gen II (1998 & up), (0L100040 & up)
 Used with: 18-2400 Complete Lower Gear Case



18-2416
COMPLETE UPPER GEAR CASE
 Replaces: 1547-861063A12
 For: Alpha Gen II (1991 & UP) for gear ratios 1.47:1, 1.50:1.
 Used with 18-2411 Drive Shaft Housing Assembly



18-2417
COMPLETE UPPER GEAR CASE
 Replaces: 1547-861063A10
 For: Alpha Gen II (1991 & UP) for gear ratios 1.62:1, 1.65:1, 2.0:1.
 Used with: 18-2411 Drive Shaft Housing Assembly



18-2418
COMPLETE UPPER GEAR CASE
 Replaces: 1547-861063A8
 For: Gen II (1991 & UP) for gear ratios 1.81:1, 1.84:1.
 Used with: 18-2411 Drive Shaft Housing Assembly



18-2419
COMPLETE UPPER GEAR CASE
 Replaces: 1547-861063A6
 For: Alpha Gen II (1991 & UP) for gear ratios 1.98:1 and 2.40:1
 Used with: 18-2411 Drive Shaft Housing Assembly



18-2450
COMPLETE UPPER GEAR CASE
 Replaces: 1547-9412A20
 1.5:1/1.47:1



18-2451
COMPLETE UPPER GEAR CASE
 Replaces: 1547-9412A21
 1.65:1/1.62:1



18-2452
COMPLETE UPPER GEAR CASE
 Replaces: 1547-9412A22
 1.84:1/1.81:1



18-2453
COMPLETE UPPER GEAR CASE
 Replaces: 1547-9412A23
 1.98:1/1.94:1



18-2443
COMPLETE LOWER GEAR CASE
 Replaces: 1623-8951A43
 For: R/MR/ALPHA

**18-2401
LOWER GEAR HOUSING**

Replaces: 1623-8951A27,
1623-8951A37
For: MR/ALPHA Style
Bore size 3.2635-3.2650. Includes tapered roller bearing for non-tractor 14/28 or 17/28 gears. When installing new gears use 18-2206-1 gear kit which includes tapered roller bearing 18-1156 for tractor 13/21 gears.



**18-2358
UPPER UNIT
GEAR REPAIR KIT**

Replaces: 43-803102T1
For: 20-22 Teeth: 1.50:1 (1.47:1)
Gen II applications serial number range up to OK999999 only



**18-2363
UPPER UNIT
GEAR REPAIR KIT**

Replaces: 43-803118T1
For: 20-24 Teeth: 1.98:1 (1.94/2.40:1)
Gen II applications serial number range up to OK999999 only



**18-2364
UPPER UNIT
GEAR REPAIR KIT**

Replaces: 43-803119T1
For: 24-24 Teeth: 1.65:1 (1.62:1)
Gen II applications serial number range up to OK999999 only



**18-2365
UPPER UNIT
GEAR REPAIR KIT**

Replaces: 43-803120T1
For: 17-19 Teeth: 1.84:1 (1.81:1)
Gen II applications serial number range up to OK999999 only



**18-6350K
UPPER UNIT
GEAR REPAIR KIT**

Replaces: 43-803104T1
For: Gen II (1998 & Up)(S/N OL100040 & Up)
1.62:1 and 2.00:1 Ratio



**18-6351K
UPPER UNIT
GEAR REPAIR KIT**

Replaces: 43-803103T1
For: Gen II (1998 & Up)(S/N OL100040 & Up)
1.47:1 Ratio



**18-6352K
UPPER UNIT
GEAR REPAIR KIT**

Replaces: 43-803106T1
For: Gen II (1998 & Up)(S/N OL100040 & Up)
1.94:1 and 2.40:1 Ratio



**18-6353K
UPPER UNIT
GEAR REPAIR KIT**

Replaces: 43-803105T1
For: Gen II (1998 & Up)(S/N OL100040 & Up)
1.81:1 Ratio



**18-2201
UPPER UNIT GEAR SET**

Replaces: 43-18410A2,
43-18411A2
Includes: (1) 18-1142
Mercuriser #31-32573A1
(1.5:1 Ratio)
(Drive Gear = 22 teeth Driven Gear = 20 teeth)
For most V-8 Drives and Gen II (S/N K999999 & BELOW)



Stern Drive Model	Beg. S/N	End. S/N	Stern Drive Model	Beg. S/N	End. S/N
225	3856268	4200499	888	3106717	& UP
260	4898730	6225576	V8R/MR/AlphaOne	6225577	& UP
898/228	4782330	6225576			



18-2203
UPPER UNIT GEAR SET
 Replaces: 43-45814A5
 (1.65:1 Ratio) (Drive Gear = 24 teeth
 Driven Gear = 24 teeth)
 For: 6 Cyl. Inline S/N K999999 & BELOW



18-2204
UPPER UNIT GEAR SET
 Replaces: 43-75325A3
 (1.84:1 Ratio)
 (Drive Gear = 17 teeth Driven Gear = 19 teeth)
 For: V-6 and 470/485 (4 Cyl. etc.) and Gen II
 (S/N K999999 & BELOW)



18-2205
UPPER UNIT GEAR SET
 Replaces: 43-55778A3
 (1.98:1 Ratio)
 (Drive Gear = 20 teeth Driven Gear = 24 teeth)
 For: 120/140 (S/N 2791957 & UP) and Gen II
 (S/N K999999 & BELOW)



18-6350
UPPER UNIT GEAR SET
 Replaces: 43-853640A2
 For: Gen II Upper (1998-up), 0L100040-up,
 1.62/2.00:1 Ratios (24-24 Teeth)
 Used with: 18-2417 Complete Upper Gear Case



18-6351
UPPER UNIT GEAR SET
 Replaces: 43-853641A2
 For: Alpha I (Gen II) (1998-up), 0L100040-up,
 1.47:1 Ratio (20-22 Teeth)
 Used with: 18-2416 Complete Upper Gear Case



18-6352
UPPER UNIT GEAR SET
 Replaces: 43-853642A2
 For: Alpha I (Gen II) (1998-up), 0L100040-up,
 1.94:1, 2.40:1 Ratios (20-24 Teeth)
 For: Mercruiser Vazer
 Used with: 18-2411 Drive Shaft Housing Assembly,
 18-2419 Complete Upper Gear Case



18-6353
UPPER GEAR KIT
 Replaces: 43-853643A2
 1.81 Ratio Upper Gear Set, 17-19 Teeth
 For: Alpha I Gen II 1998-up/0L00040-up
 For: Mercruiser Vazer

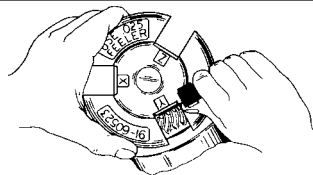

FIG. #1

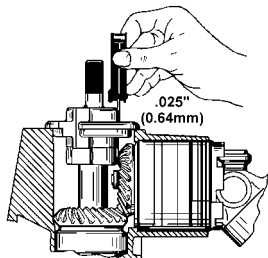

FIG. #2

FIGURES #1 - #2

Provides two separate views of the upper gear housing driven gear being properly shimmed using the Sierra installation tools.

FIGURES #3 - #4

Provides the same views of the drive gear being shimmed in the same application.

NOTE:

This installation **cannot** be performed correctly without the Sierra 18-9856 shim tool. Improper installation will result in gear failure. The .025 referenced in FIG #2 & FIG #4 is achieved when .026 will not fit the clearance but .025 will.

A service manual should always be consulted for step-by-step instructions.

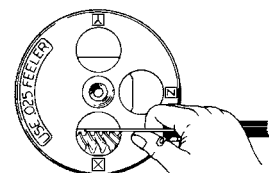

FIG. #3

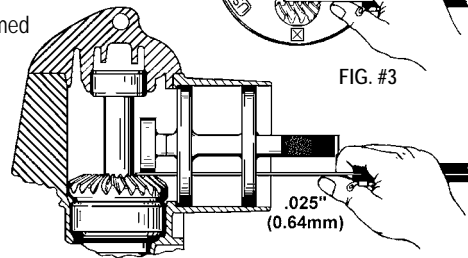

FIG. #4



18-2256
UPPER GEAR KIT
 Replaces: 43-803116T1
 Most V-8 Drives (1.5:1 Ratio)

— CONTAINS —

Part #	Description	O.E. #	Qty.
18-2201	Upper Unit Gear Set	43-18410A2	1
18-2648	Seal Kit	26-32511A2	1
18-2619-1	Outdrive Gasket Set	27-94996A1	1
18-2820	Drive Shaft Housing to Bell Housing Gasket	27-64818	1
18-2743	Drive Shaft Housing to Bell Housing Gasket	27-94996-2	1
18-1160	Bearing	31-35988A2	1
18-1165	Bearing	31-61100A1	1
18-1142	Bearing	31-35990A1	1

— CONTAINS —

Part #	Description	O.E. #	Qty.
18-2203	Gear Set	43-45814A5	1
18-2648	Seal Kit	26-32511A2	1
18-2619-1	Outdrive Gasket Set	27-94996A1	1
18-2820	Drive Shaft Housing to Bell Housing Gasket	27-64818	1
18-1160	Bearing	31-35988A2	1
18-1161	Bearing	31-35990A1	1
18-1165	Bearing	31-61100A1	1
18-2743	Drive Shaft Housing to Bell Housing Gasket	27-94996-2	1

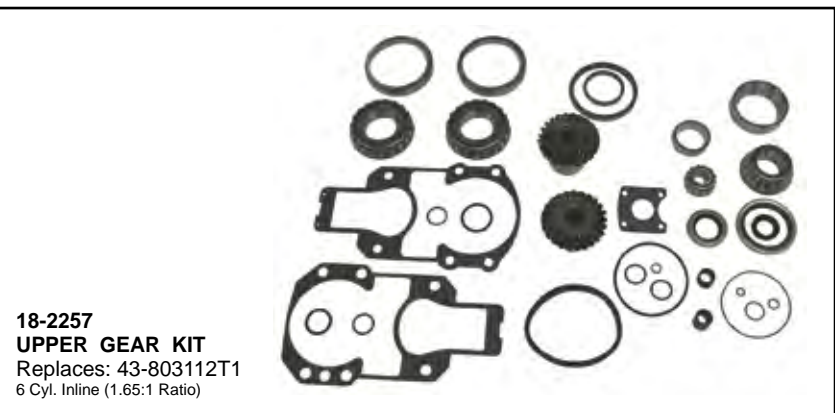

— CONTAINS —

Part #	Description	O.E. #	Qty.
18-2204	Gear Set	43-75325A3	1
18-2648	Seal Kit	26-32511A2	1
18-2619-1	Outdrive Gasket Set	27-94996A1	1
18-2820	Drive Shaft Housing to Bell Housing Gasket	27-64818	1
18-1160	Bearing	31-35988A2	1
18-1161	Bearing	31-35990A1	1
18-2743	Drive Shaft Housing to Bell Housing Gasket	27-94996-2	1
18-1165	Bearing	31-61100A1	1

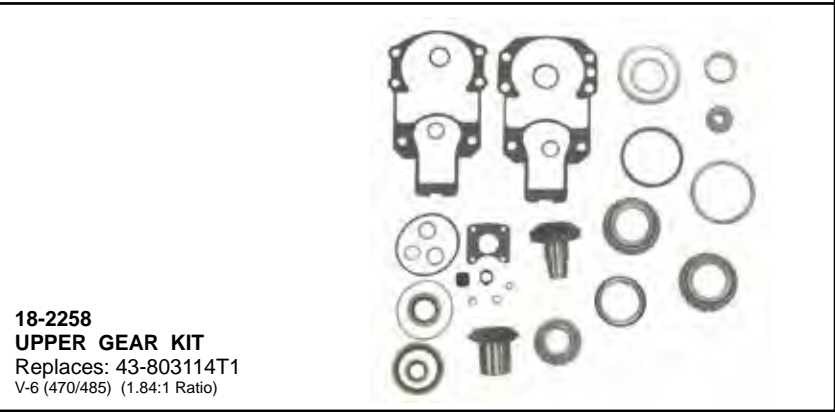

— CONTAINS —

Part #	Description	O.E. #	Qty.
18-2205	Gear Set	43-55778A3	1
18-2648	Seal Kit	26-32511A2	1
18-2619-1	Outdrive Gasket Set	27-94996A1	1
18-2820	Drive Shaft Housing to Bell Housing Gasket	27-64818	1
18-1160	Bearing	31-35988A2	1
18-1161	Bearing	31-35990A1	1
18-1165	Bearing	31-61100A1	1
18-2743	Drive Shaft Housing to Bell Housing Gasket	27-94996-2	1





**18-6401
YOKE ASSEMBLY**
Replaces: 12784A10, 864244A2
For Bravo I, II, III (OB664190 - up)
(1998-05)



**18-6402
YOKE ASSEMBLY**
Replaces: 864281A2
For: Alpha I (Gen II) (1998 & up) (OL100040 & up) GKN Style
For: Mercruiser Vazer



**18-9218
YOKE ASSEMBLY**
Replaces: 814819A2
For all #1, R/MR/ALPHA Gen II
OK999999 & Below (1971-97)



**18-2128
CENTER SOCKET**
Replaces: 39383T, 343831
(Rockwell)
Fits IA/IB/IC & EZ, MC-I, R, MR, Alpha One, Gen II
(OL949778 & below), Bravo (OM111207 & below),
MC II & TS



**18-1711
U-JOINT**
Replaces: 862132T
For: Bravo One, Two, & Three (All Ratios), Bravo One X/
Two X, Three X (All Ratios), Bravo One XR/XZ(All Ratios),
Bravo One XR Sportmaster (All Ratios) & Integrated Transom



**18-2097
U-JOINT**
Permalube
Replaces: 805536A2
For: Generation II F680000 & UP



**18-2104
U-JOINT**
Heavy Duty
Replaces: 75832A2, 75832T
Includes both straight and 90° grease fitting.
(Rockwell)
Fits all #1 and ALPHA I Units S/N 1684188-B418818.
Also TR/TRS and II SSM.



**18-2174
U-JOINT**
Heavy Duty
Replaces: 75832A3, 758321, 75832T1
Includes both straight and 90° grease fitting.
(Rockwell)
Fits ALPHA I Units S/N B418819 & above.
Also fits ALPHA I SS & BRAVO



**18-6406
U-JOINT ASSEMBLY**
Replaces: 865496A01, 865493A01
GKN new style with external clips.
Fits: Alpha I Gen II OL949779 & UP,
Bravo OM111208 & UP
For: Mercruiser Vazer



**18-8311
GIMBAL HOUSING REBUILD KIT**
Fits: Alpha One



**18-8312
GIMBAL HOUSING REBUILD KIT**
Fits: Gen II



**18-8313
GIMBAL HOUSING REBUILD KIT**
Fits: Bravo



**18-21001
GIMBAL BEARING**
Replaces: 30-879194A02
Fits: MC-1, R, MR and Alpha(1974-97),
Gen II(1991-97), Bravo I/II/III (1988-95)



**18-21006
GIMBAL BEARING**
Replaces: 30-879194A01
Fits: Gen II (1998-10), Bravo I/II/III & X/XR/XZ (1996-10)



**18-21005
GIMBAL BEARING**
Replaces: 30-862540A3
Fits: All Bravos, Alpha One Gen II (1998-up)



**18-21005K
SEAL & GIMBAL BEARING KIT**
Fits: Gen II (1998-Up) and all Bravo



**18-2101
GIMBAL BEARING**
Replaces: 30-36418
(Link-Belt)



**18-2100
HEAVY DUTY GIMBAL BEARING**
Replaces: 30-60794A4
(Link Belt)
Fits: Mercruiser- 120HP / 140HP
(2791957-6225576) (With Gimbal Trim Sender), 165HP (2763442 & Up),
225S (3856268-4200499), 228HP (4782330 & Up), 233HP (4200500 & Up),
250HP (4791300 & Up)



**18-2100K
SEAL & GIMBAL
BEARING KIT**
Fits: 1, R, MR and Alpha (1974-97)



**18-1705
HINGE PIN**
Replaces: 77123
(with grease port) For gimbal housing
Fits: Alpha, Alpha Gen II
S/N 0M815638 & Lower



**18-1706
HINGE PIN**
Replaces: 10-86801
For gimbal housing
Fits: Alpha Gen II S/N 0M85639 & UP
Bravo All Models with trim sender



**18-2381
UPPER DRIVE UNIT CAP**
Replaces: 94998A2, 94998A4
S/N 6225577 & Later Alpha I, except Gen II



**18-2382
UPPER DRIVE UNIT CAP**
Replaces: 828692A1
For: Gen II S/N F680000 & UP

GIMBAL BEARING APPLICATION

Model	Year Range	Beginning Serial No.	Ending Serial No.	Gimbal Bearing	Model	Year Range	Beginning Serial No.	Ending Serial No.	Gimbal Bearing
60	1965-1972	1830753	3225967		898 / 228	1977-1982	4782330	6225576	18-21001
80	1965-1972	1830753	3225967		250 / 260	1977-1982	1791300	6225576	18-21001
90	1965-1972	1830753	3225967		R / MR / ALPHA I	1983-1990	6225577	& UP	18-21001
I	1963	1534570	1684187		ALPHA I SS	1986-1989	A545004	& UP	18-21001
IA	1964	1684186	1777798	18-2101	ALPHA I GEN II	1991-1997	D469859	K999999	18-21001
IB	1964	1684188	1777798	18-2101	ALPHA I GEN II	1998-2010	L100040	& UP	18-21001
IC	1964	1684188	1777798	18-2101	VASER	2007-2010	W995000	& UP	
EZ-SHIFT	1964	1684188	1777798	18-2101	BRAVO I	1988-1995	B664190	F729999	18-21001
120 / 140	1967-1973	2062141	3780849	18-2101	BRAVO II	1988-1995	B664190	F729999	18-21001
120 / 140	1974-1982	3780850	6225576	18-21001	BRAVO III	1988-1995	B664190	F729999	18-21001
470 / 485	1976-1982	4208730	6225575	18-21001	BRAVO I	1996-2010	F730000	& UP	18-21006
160 / 165	1967-1973	2065190	3780849	18-2101	BRAVO II	1996-2010	F730000	& UP	18-21006
165	1974-1981	3780850	& UP	18-21001	BRAVO III	1996-2010	F730000	& UP	18-21006
888	1971-1973	3106717	3784374	18-2101	X / XR / XZ	1996-2010	F730000	& UP	18-21006
888	1974-1977	3784375	& UP	18-21001	BLACK HAWK	1994-1995	F186717	& UP	18-21001
225 / 233	1974	3856268	& UP	18-21001					



**18-2179
DRIVE SHAFT**
Replaces: 45-55796



**18-2324
DRIVE SHAFT**
Replaces: 45-557961
For: Gen II (S/N F680000 & UP),
Mercruiser Vazer



**18-3713
LOCK NUT**
Replaces: 11-22339
5/8" - 18



**18-3712
CARRIER NUT WASHER**
Replaces: 12-45810



**18-3752
RETAINING NUT**
Replaces: 816811-1,
8168112



**18-4296
SPACER RING**
Replaces: 35983
(Upper Housing)



**18-0577
CARRIER OIL
SEAL ASSEMBLY**
Replaces: 66081A2



**18-3219
WATER TUBE &
COVER ASSEMBLY**
Replaces: 42724A3
For: Merc I and Alpha I drives
Models: I, 1A, 1B, 1C, 1CEZ, 120, 140,
160, 165, 888, 898, 228, 225-S, 233, 250,
260, 470, 485, R, MR, Alpha
18-3229 BOLT Replaces: 10-28668



**18-2322
SHIFT SHAFT**
Replaces: 621041
For: I and Alpha I



**18-2169
SHIFT ARM**
Replaces: 45589A3



**18-3749
UPPER SHIFT SHAFT**
Replaces: 816685
For: Alpha Gen II (1991-98)



**18-2599
FACE SEAL & TOOL**
Replaces: 26-816575A2
For: ALPHA I GENERATION II



**18-2622
BELL HOUSING BUSHING KIT**
Replaces: 23-805041A2



**18-3760
BELL HOUSING BUSHING KIT**
Replaces: 23-806036A1
For: GEN II Serial # F680000 & UP



**18-2161
SHIFT ARM**
Replaces: 45518A2



**18-2170
SHIFT ARM SCREW**
Replaces: 10-45590



**18-2162
SHIFT CABLE SLIDE
& SCREW**
Replaces: 33981T



**18-2162E
SHIFT CABLE SLIDE
& SCREW**
For Extreme Cables Only

PKG. OF 5



**18-2163
18-2163-9①
SHIFT SLIDE SCREW**
Replaces: 10-31700

PKG. OF 5



**18-2163E-9①
SHIFT SLIDE SCREW**
For Extreme Cables Only



**18-2715
CHECK VALVE KIT**
Replaces: 24-17997A1
For: Alpha I Generation II and
Bravo I, II, and III Drives

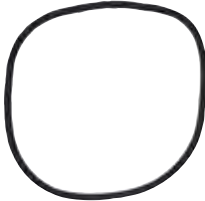

**18-2724
TRANSOM SEAL**
Replaces: 3713
For: Alpha Gen II, All Bravo

① Priced per Package

— CONTAINS —

Part #	Description	O.E. #	Qty.
18-2619-1	Outdrive Gasket Set	27-64818A3 27-94996A1,Q2	1
18-2100	Gimbal Bearing	30-60794A4	1
18-2161	Shift Arm	45518A2	1
18-2751	U-Joint Bellows	60932A4	1
18-2750	Exhaust Bellows	32734A3, 18654A1	1
18-2753-1	Shift Cable Bellows	74639	1
18-3601	Water Intake Hose	32-32461	1
18-3602	Water Intake Hose	32-41725-33	1
18-7310	Hose Clamp	—	2
18-7314	Stainless Steel Hose Clamp	—	1
18-7315	Stainless Steel Hose Clamp	—	1



**18-2601-1
TRANSOM SEAL KIT**
Replaces: 30-803097T1
R, MR, ALPHA 1 (1983-90) S/N 6225577 & UP
ALPHA 1 SS (1986-89) S/N OA 545004 & UP

— CONTAINS —

Part #	Description	O.E. #	Qty.
18-2100	Gimbal Bearing	30-60794A4	1
18-2751	U-Joint Bellows	60932A4	1
18-2760	Exhaust Tube	78458A1	1
18-3601	Water Intake Hose	32-32461	1
18-3602	Water Intake Hose	32-41725-33	1
18-2743	Drive Shaft Housing to Bell Housing Gasket	27-94996-2	1
18-2840	Bell Housing Gasket	27-35982	1
18-7153	O-Ring	25-25439	1
18-7117	O-Ring	25-35027	1
18-7310	Hose Clamp	—	2
18-7170	O-Ring	25-33504	1
18-7312	Hose Clamp	—	1
18-2753-1	Shift Cable Bellows	74639	1
18-7321	Bellows Clamp	54-38863	1



**18-8205
TRANSOM SEAL KIT**
Replaces: 30-803098T1
For: 1, R, MR, Alpha 1 with exhaust tube

— CONTAINS —

Part #	Description	O.E. #	Qty.
18-3602	Water Intake Hose	32-41725-33	1
18-7310	Hose Clamp	—	2
18-7312	Hose Clamp	—	1
18-2753-1	Shift Cable Bellows	74639	1
18-7321	Bellows Clamp	54-38863	1
18-2100	Gimbal Bearing	30-60794A4	1
18-2743	Drive Shaft Housing to Bell Housing Gasket	27-94996-2	1
18-2840	Bell Housing Gasket	27-35982	1
18-7153	O-Ring	25-25439	1
18-7170	O-Ring	25-33504	1
18-7117	O-Ring	25-35027	1
18-2750	Exhaust Bellows	18654A1, 32734A3	1
18-2747	Drive Bellows	816431A1	1



**18-8206-1
TRANSOM SEAL KIT**
Replaces: 30-803099T1
For: Alpha 1 Gen II

— CONTAINS —

Part #	Description	O.E. #	Qty.
18-2753-1	Shift Cable Bellow	74639	1
18-2100	Gimbal Bearing	30-60794A4	1
18-2756	U-Joint Bellows	86840A3	1
18-2750	Exhaust Bellows	32734A3	1
18-2760	Exhaust Tube	78458A1	1
18-3603	Water Hose	32-43437	1
18-2615	Outdrive Mounting Kit	16755A1	1



**18-8212
TRANSOM SEAL KIT**
Replaces: 30-803100T1
For: All Bravos 1982 & up



**18-8213
TRANSOM SEAL KIT**
Replaces:
Mercury 30-803097T1
For: R, MR, Alpha 1 (1983-90)
S/N 6225577-0D469858; Alpha
1 SS (1986-89) S/N OA545004
& Up



**18-8217
TRANSOM SEAL KIT**
Replaces:
Mercury 30-803098T1
For: R, MR, Alpha 1 (1983-90)
w/exhaust tube S/N 6225577-
0D469858; Alpha 1 SS (1986-89)
w/exhaust tube S/N OA545004
& Up



**18-8218
TRANSOM SEAL KIT**
Replaces:
Mercury 30-803099T1
For: Alpha 1 Gen II (1991 &
Up) S/N 0D469859 & Up







**18-8219
TRANSOM SEAL KIT**
Replaces:
Mercury 30-803100T1
For: Bravo I/II/III (1988 &
Up) S/N 0B664190 & Up;
Blackhawk (1994-95) S/N
0F186717 & Up

 <p>18-2747 U-JOINT BELLOWS Alpha 1, Gen II Replaces: 816431A1</p>	 <p>18-2750 EXHAUST BELLOWS All #1 Units, Gen II, TRS, & Bravo I, II, III Replaces: 32734A3, 18654A1 (Includes 18-7314 Clamp)</p>	 <p>18-2751 U-JOINT BELLOWS All #1 units with ridge (S/N 3469428 & UP) Replaces: 60932A4 (Includes 18-7316 Clamp)</p>
--	---	--

 <p>18-2752 U-JOINT BELLOWS All #1 units without ridge (S/N 3443920 & BELOW) Replaces: 36223A2 (Includes 18-7316 Clamp)</p>	<p>① 18-2753-2D</p>  <p>18-2753-2 SHIFT CABLE BELLOWS All #1, #2 units, Alpha, Bravo I, II, III Replaces: 74639, 74639A2 (Includes 18-7321 Clamp)</p>	 <p>18-2756 U-JOINT BELLOWS Replaces: 86840A3, 86840A05 Fits all Bravo and Blackhawk models</p>	 <p>18-1710 BELLOW FLANGE RING Replaces: 862209 Fits: All Bravo</p>
--	---	---	--

 <p>18-1728 BELLOW FLANGE RING Replaces: 816607 Fits: Alpha One (GenII) (1991 and Up)</p>	 <p>18-2746 EXHAUST BOOT Replaces: 32-14358T (4" Lower Tube)</p>	 <p>18-2748 EXHAUST BOOT Replaces: 32-44348T (4" Upper Tube)</p>	 <p>18-2759 EXHAUST TUBE Replaces: 53114A1</p>
--	--	---	--

 <p>18-2760 EXHAUST TUBE Replaces: 78458A1 (Includes 18-7314 Clamp) For: #1, Bravo I, II, III</p>	 <p>18-2761 EXHAUST TUBE 3" I.D. Replaces: 32-90949T</p>	 <p>18-2762 EXHAUST TUBE Replaces: 70981A3</p>	 <p>18-2770 EXHAUST TUBE Replaces: 32-807458T</p>
--	---	--	--

① Items ending in "D" are Display Packaged - Regular number is Non-Display

BELLOWS APPLICATION

Model	Years	Serial #	Exhaust Bellows	Shift Cable Bellows	U-Joint Bellows
I/1A/1B/1C & EZ	1963-1966	1534570-2065186	18-2750	18-2753-2	18-2752
120/140/160/165	1967-1972	2062141-3443920	18-2750	18-2753-2	18-2752
120/140/160/165	1972-1982	3469428-6225576	18-2750	18-2753-2	18-2751
888	1971-1972	3106717-3472477	18-2750	18-2753-2	18-2752
888	1973-1977	3472478 & Up	18-2750	18-2753-2	18-2751
225/233	1974-1977	3856268 & Up	18-2750	18-2753-2	18-2751
898/228/250/260	1977-1982	4782330-6225576	18-2750	18-2753-2	18-2751
R/MR/Alpha One	1983-1990	6225577 & Up	18-2750	18-2753-2	18-2751
R/MR/Alpha One	1983-1990	6225577 & Up	18-2760 ②	18-2753-2	18-2751
Alpha One Gen II	1991 & Newer	0D469859 & Up	18-2750	18-2753-2	18-2747
Bravo I/II/III	1988 & Newer	0B664190 & Up	18-2750	18-2753-2	18-2756
Bravo I/II/III	1988 & Newer	0B664190 & Up	18-2760 ②	18-2753-2	18-2756
Blackhawk	1994-1995	0F18677 & Up	18-2750	18-2753-2	18-2756
Blackhawk	1994-1995	0F18677 & Up	18-2760 ②	18-2753-2	18-2756
II	1962-1969	1474909-2671321	—	18-2753-2	—
215H	1970	2782203-2909034	—	—	18-2752
215E	1970-1972	2909035-2915034	—	18-2753-2	18-2752
TR/TRS	1973-1993	3377316 & Up	—	—	18-2751

② Tube



PKG. OF 5

18-9031
BELLOWS ADHESIVE
 Replaces: 92-86166
 2 Fluid oz.



18-7321
18-7321-9²
BELLOWS CLAMP
 Replaces: 54-38863



INNER SHIFT CABLE
18-2159
 Replaces: 66069A2
 Use in 18-2157, 18-2158 and their Mercruiser equivalent as replacement wire and tube
 Stranded Core 73"
18-2189
 Replaces: 38399A2
 Use with 18-2248
 Inner Core Wire 59"



18-2160
SHIFT CABLE SUPPORT TUBE
 Replaces: 32-38377
 Replaces tube on 18-2157, 18-2158 & 18-2159



18-2248
SHIFT CABLE ASSEMBLY
 Replaces: 73723A1
 Mercruiser #1 Drives S/N 1562900-6225576 for forward installation into bell housing. Has new style armored strand construction. (No support tube) 54" conduit with hardware package.



18-2157
 Replaces:
 41951A1, 19543A4
 Mercruiser 1 drives S/N 6225577 & UP For AFT installation into bell housing. Has old style stranded core wire with soldered tip (Uses Support Tube).
18-2158
 Mercruiser #1 Drives S/N 1562900-6225576 for forward installation into bell housing. Has old style stranded core wire with soldered tip. (Uses support tube) 63" conduit



SHIFT CABLE ASSEMBLY

18-2190
SHIFT CABLE ASSEMBLY
 Replaces: 19543A4, A10
 Mercruiser 1 drives S/N 6225577 & UP
 For AFT installation into bell housing. For use in applications using core wire with armored strand construction (No Support Tube). 63" Conduit with hardware package.



18-2190E
SHIFT CABLE ASSEMBLY
 Replaces: 19543A4, 19543A10
 S/N 6225577 & UP. For AFT installation into bell housing. For use in applications using core wire with armored strand construction (No Support Tube). 63" Conduit with hardware package. Lower Shift Cable- Alpha One (Gen II) (1991-97)
 Requires 18-9806E (Xtreme Shift Cable Tool) to complete installation



XTREME

18-2145
SHIFT CABLE
 Replaces: 815471A3, A6

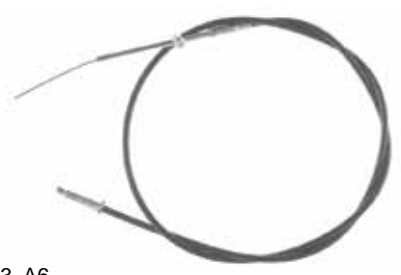

18-2145E
SHIFT CABLE
 Replaces: 815471, A3, A6
 Bravo One, Two, & Three (All Ratios), Bravo One X/Two X, Three X (All Ratios), Bravo One XR/XZ (All Ratios), Bravo One XR Sportmaster (All Ratios) & Integrated Transom

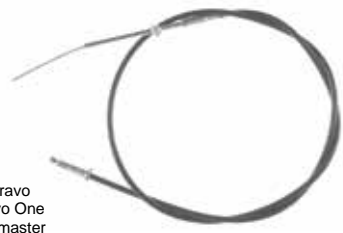

XTREME

18-9806E
SHIFT CABLE TOOL
 Installs and removes shift cables on MC-I, R-MR, Alpha I, Alpha I Gen II drive units. Use with 18-2190 and 18-2190E cables.



18-2149
SHIFT CABLE GUIDE
 Replaces: 43433
 For: Alpha & Bravo cables



PKG OF 25



18-2303
18-2303-9^①
ANCHOR
SCREW SET
 Replaces: 10-20518
 For: #1R, MR, Alpha, Alpha I,
 Gen II & Bravo



18-3754
CABLE ANCHOR
 Replaces: 43436
 For: #1R, MR, Alpha, Alpha I, Gen II
 & Bravo



18-2600
LOWER SHIFT CABLE KIT
 — CONTAINS —

Part #	Description	O.E. #	Qty.
18-2619-1	Outdrive Gasket Set	27-94996A1	1
18-2753-1	Shift Cable Bellows	74639	1
18-2248	Shift Cable Assembly	73723A1	1
18-2162	Shift Slide & Screw	33981T	1
18-2149	Shift Cable End Kit	43433	1
18-2163	Shift Slide Screw	10-31700	1
18-2743	Drive Shaft Housing to Bell Housing Gasket	27-94996-2	1
18-2820	Drive Shaft Housing to Bell Housing Gasket	27-64818	1
18-2843	Drive Shaft Housing to Bell Housing Gasket	27-94996	1



18-2603
LOWER SHIFT CABLE KIT
 Replaces: 19543T-1
ALPHA I GENERATION II
 — CONTAINS —

Part #	Description	O.E. #	Qty.
18-2619-1	Outdrive Gasket Set	27-94996A1	1
18-2753-1	Shift Cable Bellows	74639	1
18-2190	Shift Cable Assembly	19543A4	1
18-2743	Drive Shaft Housing to Bell Housing Gasket	27-94996-2	1



18-2603E
LOWER SHIFT CABLE KIT (EXTREME)
 Replaces: 19543T1
 For: Alpha I Gen II
 Requires 18-9806E (Xtreme Shift Cable Tool) to complete installation



18-2604
LOWER SHIFT CABLE KIT
 Replaces: 815471T1
BRAVO
 — CONTAINS —

Part #	Description	O.E. #	Qty.
18-2145	Bravo Shift Cable	815471A3	1
18-2149	Shift Cable End Kit	43433	1
18-2753-1	Shift Cable Bellows	74639	1
18-2615	Outdrive Gasket Set	—	1



18-2604E
LOWER SHIFT CABLE KIT (EXTREME)
 Replaces: 815471T1
 For: Bravo

STAINLESS STEEL CLAMPS		
Part #	Diameter Size	Std. #
18-7307	5/16" to 7/8"	006
18-7308	9/16" to 1 1/16"	010
18-7309	9/16" to 1 1/4"	012
18-7310	1 1/16" to 1 1/2"	016
18-7311	3/4" to 1 3/4"	020
18-7312	1 1/16" to 2"	024
18-7313	1 9/16" to 2 1/2"	032
18-7314 ^②	2 9/16" to 3 1/2"	048
18-7315	2 1/2" to 4 1/2"	064
18-7316 ^③	3" to 5"	072
18-7317	5" to 7"	104

GRADE 316
STAINLESS STEEL WORM GEAR HOSE CLAMPS



All components are manufactured from Marine Grade 316 stainless steel. These clamps are designed to fit many applications from 5/16" to 7" diameter hoses.



18-2175
ENGINE COUPLER
 Replaces: 18643A7
 Flex plate style for late model, small crankshaft bolt pattern, style engines



18-2195
ENGINE COUPLER
 Replaces: 12632A7
 Flex plate style for GM 4 Cyl engines with late style, small crankshaft bolt pattern

^① For use with 3" Bellows ^② O.E. #54-32533 ^③ O.E. #s 54-31765, 54-815504372



18-4442
ENGINE ALIGNMENT TOOL
 Replaces: 91-57797A3
 For use with all #1 units

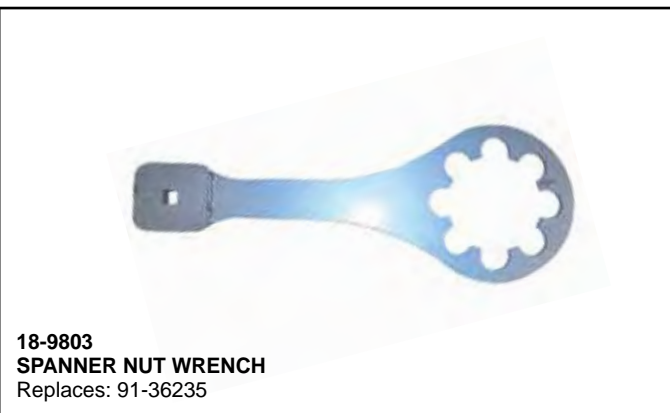

18-9803
SPANNER NUT WRENCH
 Replaces: 91-36235



18-9200
SPLINE GREASE
 14 oz.
 Replaces: 92-816391A4
 Specialty grease used in the assembly of engine yokes and couplers



18-2200
LOWER UNIT GEAR SET
 Replaces: 43-96084A4
 888 S/N 3106717 & UP #1 Units S/N 3469428 & UP Except, MR/ALPHA Units (which have no pre-load pin in the top of the drive shaft).



18-2410
FORWARD GEAR SET
 Replaces: 43-96084A7
 For: "R" drive



18-2360
PINION & FORWARD GEAR SET
 Replaces: 43-828072A3
 13-21 Teeth



18-2206-1
LOWER UNIT GEAR SET
 Replaces: 43-878087A2 + 43-828073A1, 43-828072A2
 For: All MR/ALPHA/Gen II
 (Except Gen II 2.00-2.40 ratios)



18-2409
REVERSE GEAR
 Replaces: 43-92320T
 For: "R" drive (28 teeth)



18-2406
FORWARD GEAR SET
 Replaces: 43-878087A2
 For: MR/Alpha/Gen II lower S/N D469859 & UP



18-2408
REVERSE GEAR
 Replaces: 43-828073A1
 For: Alpha I/Gen II lower S/N D469859 & UP

18-2404
GEAR REPAIR KIT
 Replaces: 43-803079T1
 For: "R" drive



— CONTAINS —

Part #	Description	O.E. #	Qty.
18-2200	Lower Unit Gear Set	43-96084A4	1
18-2202	Sliding Clutch	52-66063	1
18-1157	Needle Roller Bearing	31-30895	1
18-1155	Ball Bearing	30-88957A1	1
18-1159	Tapered Roller Bearing	31-35928A1	1
18-2285	Shim	15-47397A1	1
18-3719	Pinion Nut	11-35921	1
18-2299	Tab Washer	14-79447	1

18-2405
GEAR REPAIR KIT
 Replaces: 43-803091T1
 For: MR/Alpha I



— CONTAINS —

Part #	Description	O.E. #	Qty.
18-2652	Lower Gear Housing Seal Kit	26-33144A2	1
18-3719	Pinion Nut	11-35921	1
18-2343	Washer	12-982721	1
18-2298	Tab Washer	14-18323	1
18-2299	Tab Washer	14-79447	1
18-2206-1	Gear Set	43-42934	1
18-2285	Shim	15-47397A1	1
18-1155	Ball Bearing	30-88957A1	1
18-1158	Needle Roller Bearing	31-30956	1
18-1117	Pinion Bearing	31-42647A1	1
18-1143	Alpha Bearing	31-36387A1	1
18-2294	Shim Kit	15-42637A-1	1
18-2202	Sliding Clutch	52-66063	1



18-2368
LOWER GEARCASE KIT
 Replaces: 43-803071T1
 ALPHA/GEN II 1996-97



18-2369
LOWER GEARCASE KIT
 Replaces: 43-803069T1
 ALPHA/GENII 1991-95

18-2407
GEAR SET
 Replaces: 43-878087A4
 For: MR/Alpha/Gen II
 lower gear housings



— CONTAINS —

Part #	Description	O.E. #	Qty.
18-2206-1	Gear Set	43-42934	1
18-1155	Ball Bearing	30-88957A1	1
18-1117	Pinion Bearing	31-42647A1	1
18-1158	Needle Roller Bearing	31-30956	1
18-1143	Alpha Bearing	31-36387A1	1
18-2294	Shim Kit	15-42637A-1	1
18-2285	Shim	15-47397	1
18-3719	Pinion Nut	11-35921	1
18-2343	Washer	12-982721	1



18-2202
SLIDING CLUTCH
 Replaces:
 52-66063,
 52-853594T
 888 S/N 3784375 & UP
 #1 Units S/N 3469428 & UP



18-2357
CROSS PIN
 Replaces:
 17-30632

PKG. OF 2



18-2348
18-2348-9^①
CLUTCH CROSS PIN SPRING
 Replaces: 24-30893
 1/MC-1/R/MR/Alpha
 Mercruiser/Gen II lower
 S/N D469859-F679999
 Mercruiser Vazer



18-2166
PROP SHAFT
 Replaces: 44-66060, 44-66060-3, 44-824110, 44-860308
 For all #1 & MR/ALPHA Units S/N 2791957 & above.
 Also for 165 (6 cyl.) S/N 2763442 & above.

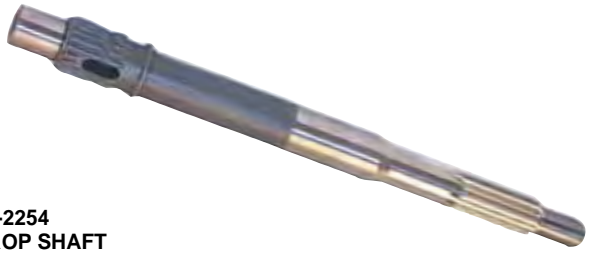

18-2254
PROP SHAFT
 Replaces: 44-850308
 For: Alpha One Gen II S/N 0L100040 & up/Vazer

① Priced per Package



**18-2167
DRIVE SHAFT**
Replaces: 45-41939A1
For all #1 units S/N 2791957 & above except MR/ALPHA Units or units which have been retro-fitted with MR/ALPHA lower units. Also for 165 (6 cyl.) S/N 2763442 & above.



**18-2180
DRIVE SHAFT**
Replaces: 45-42634
For all MR/ALPHA Units & older units which have been retro-fitted with MR/ALPHA lower units.



**18-2331
DRIVE SHAFT**
Replaces: 45-853648
For: Ratios 1.47, 1.62, 1.81 & 1.94.
Fits: Gen II (1998 & up), (OL100040 & up)
For use with: 18-2400 Complete Lower Gear Case



**18-2261
DRIVE SHAFT**
Replaces: 45-816919
All Alpha I Generation II Drives (with new style 18-3056 Impeller)
Serial #D494569 & above.



**18-2346
RETAINER NUT**
Replaces: 824519
For: MR Alpha & Gen II



**18-3719
PINION NUT**
Replaces: 11-35921



**18-2359
DRIVE SHAFT NUT SET**
Replaces: 12-92721 & 11-35921
Contains:
18-3719 Pinion Nut
18-2343 Pinion Nut Washer



18-2286
Replaces: 19755A2

18-2196
Replaces: 19755A4

SHIFT SPOOL ASSEMBLIES

SHIFT SPOOL ASSEMBLY APPLICATION		
Model	Serial #	Part #
1A (EZ-Shift)	1776349 & UP	18-2196
1B (EZ-Shift)	1775193 & UP	18-2196
1C (EZ-Shift)	1777799 & UP	18-2196
120/140	2062141-3780849	18-2196
120/140	3780850 & UP	18-2286
160	2065190-2763441	18-2196
165	2763442-3780849	18-2196
165	3780850 & UP	18-2286
888	3106717-3784374	18-2196
888	3784375 & UP	18-2286
898/228	4782330 & UP	18-2286
225-S	3856268-4200499	18-2286
233	4200500 & UP	18-2286
470/485	4208730 & UP	18-2286
R/MR/Alpha One	6225377 & UP	18-2286
Alpha One (Gen II)	D494569 & UP	18-2286



**18-3759
THRUST BEARING RING**
Replaces: 35915



**18-2342
THRUST RING**
Replaces: 681001
For: MR/ ALPHA



**18-2191
CARRIER BEARING**
Replaces: 73020A14
For: #1R/MR/Alpha I
For: Housings with casting #73020C

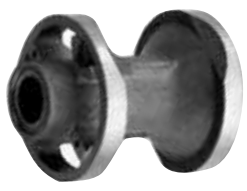

18-2376
CARRIER BEARING
 Replaces: 818763A10
 For: Alpha Gen II & MR Units
 For: Housings with casting #73020C1, Mercruiser Vazer



18-2150
SHIFT SHAFT
 Replaces: 774811
 Stainless Steel



18-2353
SHIFT ROD BUSHING ASSEMBLY
 Replaces: 23-815921A21



18-2154
SHIFT SHAFT HOUSING BUSHING
 Replaces: 23-30617A2
 Mercruiser & Alpha 1 (S/N 1684188 & UP)



18-3198
WATER PICK-UP
 Port
 Replaces: 934241
 For: MR Alpha



18-3199
WATER PICK-UP
 Starboard
 Replaces: 934231
 For: MR Alpha



18-2320
SHIFT SHAFT
 Replaces: 815919A1
 For: Gen II



18-2130
SHIFT CRANK
 Replaces: 76865
 For All #1 Units R/MR/Alpha,
 Mercruiser Vazer

PKG. OF 2



18-4295
18-4295-9^①
E-CLIP
 Replaces: 53-29641
 For: Gen II



18-2299
TAB WASHER
 Replaces: 14-79447



18-2298
TAB WASHER
 Replaces: 14-18323



18-3751
SPANNER NUT
 Replaces: 79448
 For: Mercruiser Vazer



18-2354
CARRIER SEAL
 Replaces: 821759A4

PKG. OF 2



18-2707
18-2707-9^①
COLLAR KEEPER
 Replaces: 97351
 For: Bravo



18-1117
PINION BEARING
 Replaces: 31-42647A1



18-1356
PINION BEARING
 Replaces: 31-54928



18-1142
UPPER PINION BEARING
 Replaces: 31-32573A1

Model	Year	Model	Year
215 E/H	1970-72	II, TR	1973-76
225TRS, 280 TRS	1973-76	TR, TRS	1977-93

^① Priced per Package



**18-1193
TAPERED
ROLLER BEARING**
Replaces: 31-33138A1
Fits: Gen II (1998-Up), Mercruiser Vazer



**18-1143
TAPERED
ROLLER BEARING**
Replaces: 31-36387A1



**18-1156
FORWARD
GEAR BEARING**
Replaces: 31-30894A1
For: Mercruiser Vazer



**18-1161
TAPERED
ROLLER BEARING**
Replaces: 31-35990A1
For: Mercruiser Vazer



**18-1162
TAPERED
ROLLER BEARING**
Replaces: 31-38356A1



**18-1164
TAPERED
ROLLER BEARING**
Replaces: 31-53079A1



**18-1165
TAPERED
ROLLER BEARING**
Replaces: 31-61100A1



**18-1173
TAPERED
ROLLER BEARING**
Replaces: 31-828437A2



**18-1179
TAPERED
ROLLER BEARING**
Replaces: 31-32575A1, T1
For: Gen II F680000 & UP,
Mercruiser Vazer



**18-1127
TAPERED
ROLLER BEARING**
Replaces: 31-54038A1
For: Bravo II - Lower (S/N B664190 & UP)



**18-1182
ROLLER BEARING KIT**
Replaces: 31-30894A5
For: Alpha I (Gen II) (1998 & up)
(OL100040 & up), Mercruiser Vazer



**18-1197
TAPERED FORWARD
GEAR BEARING**
Replaces: 31-828439A2
For: Alpha I (Gen II) (1996-97)
(OF680000-OK999999)



**18-1129
UPPER DRIVE
SHAFT BEARING**
Replaces: 31-86748A1
For: Bravo I, II, III - Lower
(S/N B664190 & UP)



**18-1150
NEEDLE ROLLER BEARING**
Replaces: 31-92366A1



**18-1157
FORWARD GEAR
INNER BEARING**
Replaces: 31-30895,
31-30895T
For: Mercruiser Vazer



**18-1158
CARRIER BEARING**
Replaces: 31-30956,T
For: Mercruiser Vazer



**18-1153
BALL BEARING**
Replaces:
30-63326, 30-63326T



18-1155
BALL BEARING
 Replaces: 30-88957A1, T



18-1160
DRIVE BEARING KIT
 Replaces: 31-35988A2, 31-35988A12

MERCURISER STERNDRIVE UPPER GEAR HOUSING BEARINGS

Sterndrive Model	Drive Ratio	Years	Serial Number	Drive Gear (Yoke)	Driven Gear	Upper Cap
IA,IB,IC & EZ Shift	All	1964-66	1684188 - 2065186	18-1160	18-1161	18-1179
120/140	1.98	1967	2062141 - 2187468	18-1160	18-1161	18-1161
120/140	1.98	1967-71	2187469 - 3134193	18-1160	18-1161	18-1179
120/140	1.98	1971-82	3134194 - 6225576	18-1160	18-1161	18-1165
470/485	1.84	1976-82	4208730 - 6225576	18-1160	18-1161	18-1165
160	1.68	1967	2065190 - 2182197	18-1160	18-1161	18-1161
160	1.68	1967-71	2182198 - 3134193	18-1160	18-1161	18-1179
165	1.65	1971-81	3213658 - UP	18-1160	18-1161	18-1165
888	1.5	1971-73	3106717 - 3134193	18-1160	18-1161	—
888	1.5	1973-77	3134194 - UP	18-1160	18-1161	18-1165
225-S	1.5	1974	3856268 - 4200499	18-1160	18-1161	18-1165
898/228	1.65	1977-82	4782330 - 6225576	18-1160	18-1161	18-1165
233	1.32	1975-77	4200500 - UP	—	—	18-1165
250	1.32	1977	4791300 - 4898729	—	—	18-1165
255-TRS	All	1973-74	3377316 - 4203749	18-1162 ③	18-1162	—
260	1.5	1978-82	4898730 - 6225576	18-1160	18-1161	18-1165
280-TRS	All	1975-76	4203750 - 4895399	18-1162 ③	18-1162	—
R/MR/Alpha One	1.98/1.84/ 1.65/1.50	1984-90	6225577 - UP	18-1160	18-1161 ① ④	18-1165
R/MR/Alpha One	1.5	1984-90	6225577 - UP	18-1160	18-1142	18-1165
R/MR/Alpha One	1.32	1984-90	6225577 - UP	—	—	18-1165
R/MR/Alpha One	1.5 Heavy Duty	1984-90	6225577 - UP	—	18-1142	18-1165
Alpha One SS	1.32	1986-89	A545004 - UP	—	—	18-1165
Alpha One SS	1.5	1986-89	A545004 - UP	—	18-1142	18-1165
Alpha One Gen II	2.40/1.98/ 1.84/1.65	1991-95	D469859 - F679999	18-1160	18-1161 ④	18-1165
Alpha One Gen II	1.5	1991-95	D469859 - F679999	18-1160	18-1142	18-1165
Alpha One Gen II	2.40/1.94/ 1.81/1.62	1996-97	F680000 - K999999	18-1160	18-1161 ④	18-1179
Alpha One Gen II	1.47	1996-97	F680000 - K999999	18-1160	18-1142	18-1179
Alpha One Gen II	2.40/2.00/ 1.94/1.81/ 1.62	1998 & Up	L100040 - UP	—	18-1161	18-1179
Alpha One Gen II	1.47	1998 & Up	L100040 - UP	—	18-1142	18-1179
II-TR	—	1973-76	3377316 - 4794899	18-1162 ②	18-1162	—
SSM II	—	1982-97	ALL	18-1162 ③	18-1162	—
TR/TRS	—	1977-93	4794900 - UP	18-1162 ③	18-1162	—
Bravo I, II, III	All	—	B664190 & UP	—	—	18-1129

① Timken Cone # 89449 / Cup 89410
 ② Straight Shoulder Gear Only

③ Bearing for U-Joint Yoke
 ④ Use 18-1142 for 1.5:1 Upper Gear Ratio

MERCUISER STERNDRIVE LOWER GEAR HOUSING BEARINGS

Sterndrive Model	Years	Beg. S/N - End. S/N	Prop Bearing Carrier	Lower Drive Shaft (Pinion)	Upper Drive Shaft	Inside Forward Gear (Needle)	Outside Forward Gear	Reverse Gear
60	1965-66	1830753 - 2063740	—	—	—	—	18-1162	—
80/90	1966-72	2063741 - 3225967	18-1158	—	—	18-1157	18-1156	—
I	1963	1534570 - 1536617	18-1158	—	18-1153	18-1157	18-1156	—
I	1963	1536618 - 1684187	18-1158	—	—	18-1157	18-1156	—
IA,IB,IC & EZ Shift	1964-66	1684188 - 2065189	18-1158	—	—	18-1157	18-1159	18-1155
120/140	1967-69	2062141 - 2791956	18-1158	—	18-1164 ④	18-1157	18-1159	18-1155
120/140	1970-77	2791957 - 4893634	18-1158	—	18-1164	18-1157	18-1159	18-1155
120/140	1978-82	4893635 - 6225576	18-1158	18-1150	18-1164	18-1157	18-1159	18-1155
470	1976-77	4208730 - 4893934	18-1158	—	18-1164	18-1157	18-1159	18-1155
470/485	1978-82	4893835 - 6225576	18-1158	18-1150	18-1164	18-1157	18-1159	18-1155
160	1967-69	2065190 - 2763441	18-1158	—	18-1164 ④	18-1157	18-1159	18-1155
165	1970-77	2763442 - 4890459	18-1158	—	18-1164	18-1157	18-1159	18-1155
165	1978-81	4890460 - UP	18-1158	18-1150	18-1164	18-1157	18-1159	18-1155
888	1971-77	3106717 - UP	18-1158	—	18-1164	18-1157	18-1159	18-1155
225/233	1974-77	3856268 - UP	18-1158	—	18-1164	18-1157	18-1159	18-1155
898/228	1977	4782330 - 4898729	18-1158	—	18-1164	18-1157	18-1159	18-1155
898/228	1978-82	4898730 - 6225576	18-1158	18-1150	18-1164	18-1157	18-1159	18-1155
250	1977	4791300 - 4898729	18-1158	—	18-1164	18-1157	18-1159	18-1155
255-TRS	1973-74	3377316 - 4203749	18-1158	—	—	—	18-1159	N/A
260	1978-82	4898730 - 6225576	18-1158	18-1150	18-1164	18-1157	18-1159	18-1155
280-TRS	1975-76	4203750 - 4895399	18-1158	—	—	—	18-1159	N/A
R	1983	6225577 - UP	18-1158	18-1150	18-1164	18-1157	18-1159	18-1155
MR / Alpha One	1984-90	6225577 - UP	18-1158	18-1117	18-1143	—	18-1159 ⑤	18-1155
MR / Alpha One	1984-90	6225577 - UP	18-1158	18-1117	18-1143	18-1157 ②	18-1159 ⑤	18-1155
MR / Alpha One (CR)	1984-90	6225577 - UP	18-1158	18-1117	18-1143	—	—	—
Alpha One SS	1986-89	A545004 - UP	18-1158	18-1117	18-1143	18-1157	18-1159	18-1155
Alpha One Gen II	1991-95	D469859 - F679999	18-1158	18-1117	18-1143	18-1157	18-1159 ⑤	18-1155
Alpha One Gen II (CR)	1991-95	D469859 - F679999	18-1158	18-1117	18-1143	—	—	—
Alpha One Gen II	1996-97	F680000 - K999999	18-1158	18-1117	18-1143	18-1157	18-1156	18-1155
Alpha One Gen II (CR)	1996-97	F680000 - K999999	18-1158	18-1117	18-1143	—	—	—
Alpha One Gen II	1998-newer	L100040 - UP	18-1158	18-1117	18-1143	18-1157	18-1156 ③	18-1155
Alpha One Gen II (CR)	1998-newer	L100040 - UP	18-1158	18-1117	18-1143	—	—	—
II	1962-67	1474909 - 2275488	—	—	—	N/A	18-1156 ③	N/A
II ③	1968-69	2398798 - 2671321	—	—	—	—	18-1162	18-1156
II-TR	1973-76	3377316 - 4794899	—	—	18-1161 ①	—	—	N/A
TR	1973-93	4794900 - UP	—	—	18-1161 ①	—	—	N/A
TRS	1973-93	4794900 - UP	18-1158	—	—	—	18-1159	N/A

① 18-1161 Top Bearing /
18-1163 Bottom Bearing

② Torrington#B1616
③ Prop Shaft Drive Gear

④ #15520 Stamped on Cup
⑤ Use 18-1173 for 2.40:1 ratio only (new style lower gears) our **18-2206-1**



18-2349
SHIFT SHAFT SLEEVE
 Replaces: 23-67370



Display Package

18-2244
18-22441-9^①
 (PKG. OF 50 WITHOUT GASKET)
DRAIN PLUG
 Replaces: 10-79953A2
 For: #1/R/MR/Alpha/Alpha I Gen II
 Both Upper And Lower Units



② **18-2375D** Display Package

18-2375
18-23751-9^①
 (PKG. OF 50 WITHOUT GASKET)
DRAIN PLUG MAGNET
 Replaces: 10-14834A1, 22-67892A1
 (Magnet)
 For: Alpha MR/Gen II lower units
Not to be used on #1/R lower units



18-2165
CONTROL BOX CAM
 Replaces: 59369



18-4220
THRUST WASHER
 Replaces: 13171, 77987
 V-6, Outboards &
 Mercruiser Sterndrives



18-3784
THRUST WASHER
 Replaces: 805100
 Fits: Bravo III (Front)



② **18-3701D** Display Package

18-3701
PROP NUT KIT
 Replaces: 11-52707A1
 —CONTAINS—

Part #	O.E. #	Description
18-3200	14-31210, 14-816629	Tab Washer
18-3700	11-52707	Prop Nut



18-3755
PROP NUT KIT
 Fits: Bravo III (Front)



18-3756
PROP NUT KIT
 Fits: Bravo III (Rear)

PKG. OF 10



18-3200
18-3200-9^①
TAB WASHER
 Replaces: 14-31210, 14-816629



18-3787
TAB WASHER
 Replaces: 805101T
 Fits: Bravo III (Rear)



18-3788-9^①
TAB WASHER
 Replaces: 14-34817
 Fits: Bravo II



18-3783
PROP NUT
 Replaces: 11-859131
 Fits: Bravo III (Front)



18-3785
PROP NUT
 Replaces: 11-826711 27
 Fits: Bravo II



18-3786
PROP NUT
 Replaces: 11-862907
 Fits: Bravo III (Rear)

① Priced per Package

② Items ending in "D" are Display Packaged - Regular number is Non-Display



**18-3700
PROP NUT**
Replaces: 11-52707



**18-3714
BRASS CASTLE WASHER**
Replaces: 12-31211A2
Fits: Alpha/Bravo I (without Flo-Torq II Hub)
NOTE: Fits above product with rubber hub propellers (non-Flo-Torq II)



**18-4444
PROP WRENCH**
Replaces: 91-95830A1

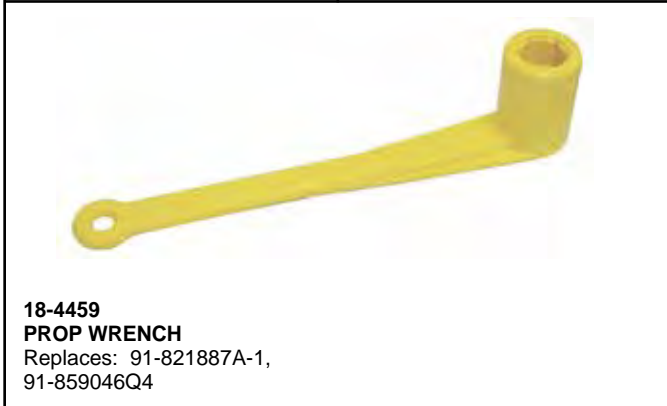

**18-4459
PROP WRENCH**
Replaces: 91-821887A-1,
91-859046Q4



**18-4446
PROP WRENCH KIT**

—CONTAINS—

Part #	O.E. #	Description
18-3200	14-31210, 14-816629	Tab Washer
18-3700	11-52707	Prop Nut
18-4444	91-95830A1	Prop Wrench

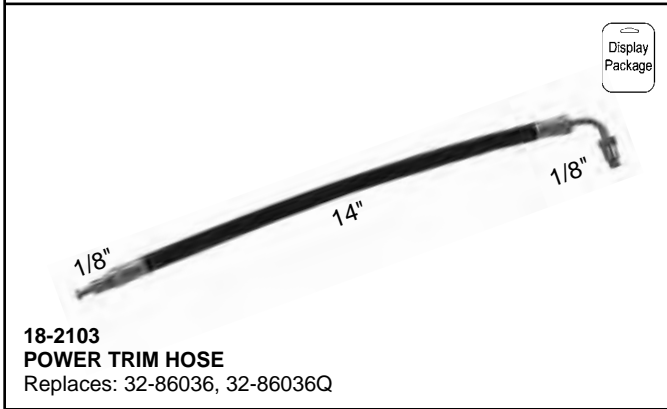

**18-2103
POWER TRIM HOSE**
Replaces: 32-86036, 32-86036Q

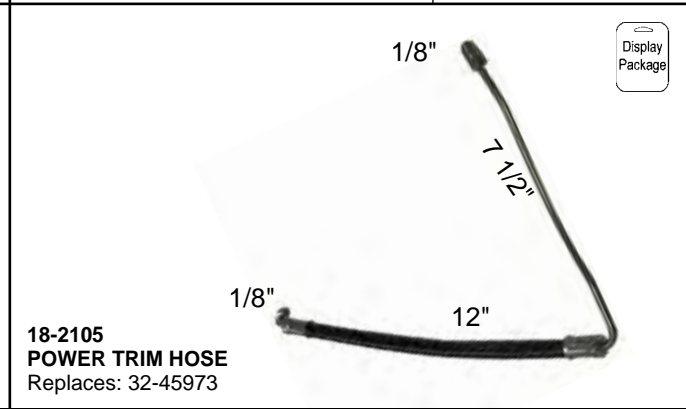

**18-2105
POWER TRIM HOSE**
Replaces: 32-45973

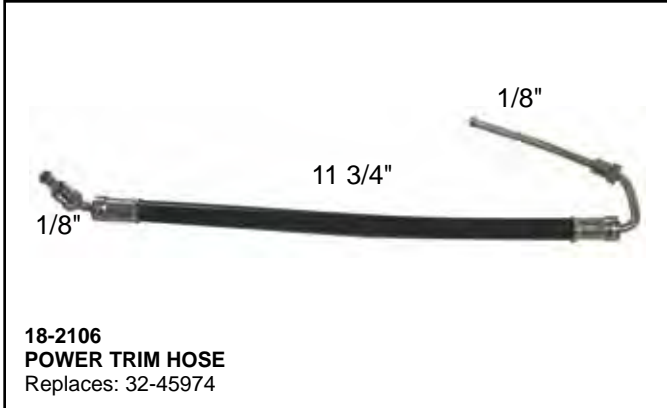

**18-2106
POWER TRIM HOSE**
Replaces: 32-45974

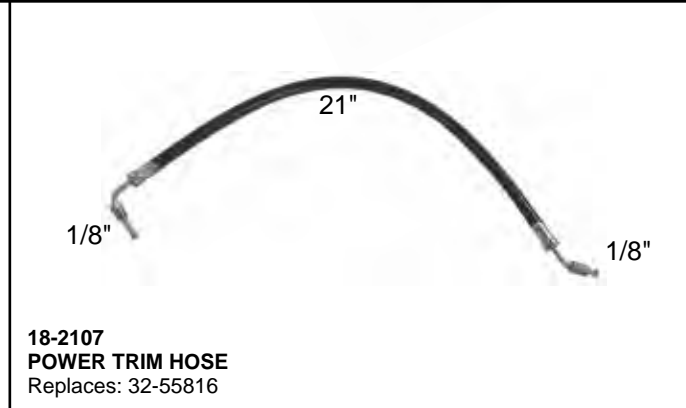

**18-2107
POWER TRIM HOSE**
Replaces: 32-55816

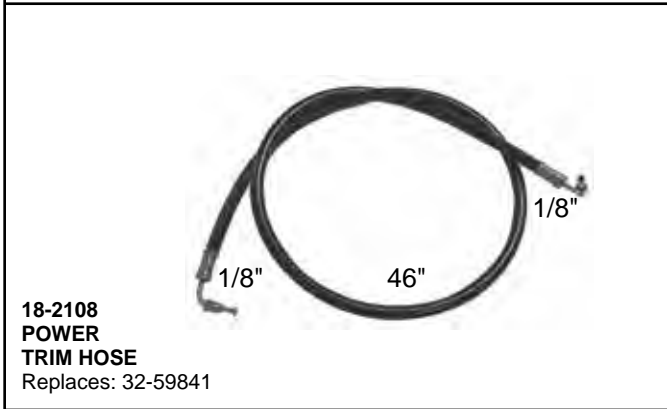

**18-2108
POWER TRIM HOSE**
Replaces: 32-59841



**18-2109
POWER TRIM HOSE**
Replaces: 32-59842

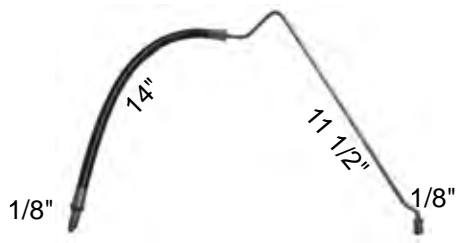

POWER TRIM HOSE
Starboard
Connector to bottom of trim cylinder MCM 120-260 & BRAVO

Part #	O.E. #	Description
18-2114	32-99902-1, 32-864960	Trim Cyl. Casting #14034-1
18-2136*	32-99902, 32-864589	Trim Cyl. Casting #98704, 98704-1

* Approximately 11 1/4" long

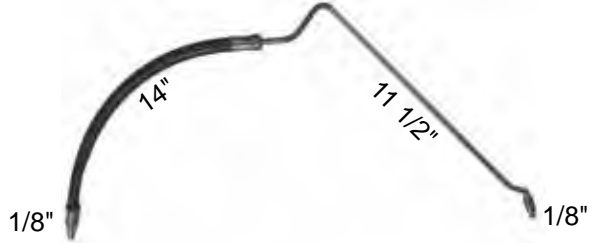

POWER TRIM HOSE
Starboard
Connector to bottom of trim cylinder MCM 120-260 & BRAVO

Part #	O.E. #	Description
18-2115	32-99903-1, 32-864959	Trim Cyl. Casting #14035-1
18-2137*	32-99903, 32-864588	Trim Cyl. Casting #98703, 98703-1

* Approximately 11 1/4" long

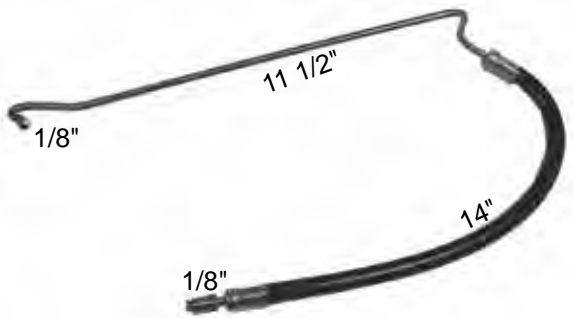

18-2112
POWER TRIM HOSE
Replaces: 32-87234

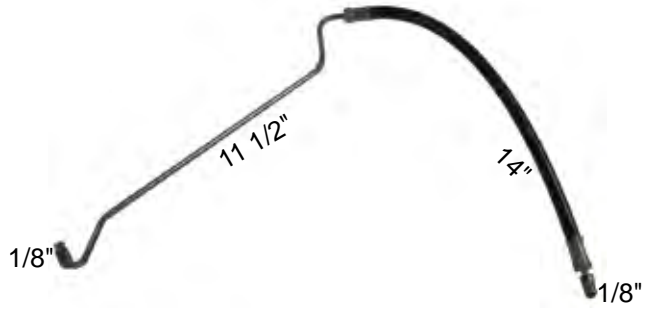

18-2113
POWER TRIM HOSE
Replaces: 32-87235



18-2435
POWER TRIM HOSE
Replaces: 32-861127, 32-95858
Fits R/MR/Alpha/Alpha Gen II/Bravo I, II, III/Bravo X, XR, XZ
Serial number 0W099999 and below without quick connect fittings.
OEM hose color is black.



18-2436
POWER TRIM HOSE
Replaces: 32-861128, 32-95859
Fits R/MR/Alpha/Alpha Gen II/Bravo I, II, III/Bravo X, XR, XZ
Serial number 0W099999 and below without quick connect fittings.
OEM hose color is gray.



18-2116
POWER TRIM HOSE
Replaces: 32-99904



18-2126
POWER TRIM HOSE
Replaces: 32-52951A1

POWER TRIM HOSE APPLICATION

Stern Drive Model	Years	Serial No.	Trim Cylinder to Connector (port down)	Trim Cylinder to Connector (port up)	Trim Cylinder to Connector (stbd down)	Trim Cylinder to Connector (stbd up)	Pump to Hydraulic Connector	Pump to Hydraulic Connector	Connector to Reverse Lock Valve	Hydraulic Pump & Reverse Lock Valve
120, 140	1967-69	2062141 - 2791956	—	18-2106	—	18-2105	—	N/A	—	18-2126
120, 140	1970-73	2791957 - 3780849	18-2103	18-2103	18-2103	18-2103	18-2107	N/A	—	18-2126
120, 140	1974-82	4893635 - 6225576	18-2103	18-2103	18-2103	18-2103	18-2107	N/A	18-2109	18-2126
470/485	1976-82	4208730 - 6225576	18-2103	18-2103	18-2103	18-2103	18-2107	N/A	18-2109	18-2126
160	1967-69	2065190 - 2763441	—	18-2106	—	18-2105	—	N/A	—	18-2126
165	1970-73	2763442 - 3780849	18-2103	18-2103	18-2103	18-2103	18-2107	N/A	—	18-2126
165	1974-81	3780850 & UP	18-2103	18-2103	18-2103	18-2103	18-2107	N/A	18-2109	18-2126
888	1974 & UP	3106717 & UP	18-2103	18-2103	18-2103	18-2103	18-2108	N/A	18-2109	—
225/233	1974-77	3856268 & UP	18-2103	18-2103	18-2103	18-2103	18-2108	N/A	18-2109	—
228/898/250/260	1977-82	4782330 - 6225576	18-2103	18-2103	18-2103	18-2103	18-2108	N/A	18-2109	—
R/MR/Alpha/SS	1983-90	6225577 & UP	18-2137 ③	18-2116	18-2136 ③	18-2116	18-2436⑤	18-2435⑤	N/A	N/A
R/MR/Alpha/SS	1983-90	6225577 & UP	18-2115 ④	18-2116	18-2114 ④	18-2116	18-2436⑤	18-2435⑤	N/A	N/A
Alpha One GEN II	1991-97	D469859 & UP	18-2115	18-2116	18-2114	18-2116	18-2436⑤	18-2435⑤	N/A	N/A
Alpha One GEN II ⑥	1998 & UP	0L100040 & UP	18-2115	18-2116	18-2114	18-2435	18-2436⑤	18-2435⑤	N/A	N/A
Bravo I,II & III ⑥	1988 & UP	B664190 & UP	18-2137	18-2116	18-2136	18-2116	18-2436⑤	18-2435⑤	N/A	N/A
Blackhawk	1994-95	F186717 & UP	18-2137	18-2116	18-2136	18-2116	18-2436⑤	18-2435⑤	N/A	N/A
II (1.78)	1968-69	2398798 - 2671321	18-2103	18-2103	18-2103	18-2103	—	N/A	—	18-2126
III	1968-72	2373127 - 3002613	18-2103	18-2103	18-2103	18-2103	—	N/A	—	—
215E/H	1970-72	2909035 - 2915034	18-2103	18-2103	18-2103	18-2103	—	N/A	—	—
TR/TRS	1973-93	3377316 & Up	18-2103 ②	18-2103	18-2103 ②	18-2103	—	N/A	—	—
TR/TRS	1973-93	3377316 & Up	18-2103 ②	18-2103	18-2103 ②	18-2103	—	N/A	—	—
TR/TRS	1973-93	3377316 & Up	— ①	18-2103	— ①	18-2103	—	N/A	—	—

- ① 90° hose end
- ② External trim lines
- ③ Internal cylinder lines
- ④ Oildyne pump
- ⑤ 18-2436 OEM hose color is gray, 18-2435 OEM hose color is black
- ⑥ Serial number 0W099999 and below without quick connect fittings.

- ★ High quality EPDM rubber cups
- ★ Metal hose connector complete with rubber washer
- ★ Use with a standard garden hose
- ★ Corrosion resistant dicromate finish
- ★ Installs in seconds
- ★ No tools required



18-9010
MOTOR FLUSHER
 Heavy Duty
 Replaces: 73971A2, 44357A2, Q2

Flushes cooling system of salts and sediments and allows engine to idle for tuning and engine adjustment in your own driveway. Simply slip attachment over the engine's side water intakes. Coated spring steel arms clamp suction cup securely over the engine's side water intakes.

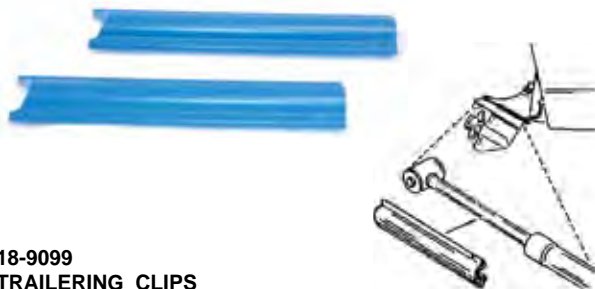

18-9099
TRAILERING CLIPS
 Replaces: 817019A1, 817019Q2
 For all ALPHA I, ALPHA Generation II, Bravo I, II, III, and Blackhawk

STAINLESS STEEL LOCKNUTS

Part #	O.E. #	Thread Size
18-3720 ③	11-34932	3/8" - 24
18-3721 ① ③	11-34933	7/16" - 20
18-3722 ② ③	11-35888, 11-20361	1/4" - 28
18-3723 ③	11-45592	5/16" - 24

① PKG OF 6 ② PKG OF 5

18-2372
TRIM CYLINDER END CAP
 Replaces: 88035
 1.850 Cap Diameter
 For: R/MR/Alpha

18-2373
TRIM CYLINDER END CAP
 Replaces: 806191T
 1.890 Cap Diameter
 For: R/MR/Alpha/ Gen II/Bravo

18-2465-9④
PIVOT PIN END CAP
 Replaces: 19-14842
 For: R/MR/Alpha One (1983-90)
 Serial No. 6225577 and up
 I/II/III (1988-02) Serial No. 6225577

18-2466-9④
PIVOT PIN END CAP
 Replaces: 19-815951
 For: Alpha One Gen II (1991-02)
 Serial No. OD469859 and up

18-2461
TRIM CYLINDER ANCHOR PIN KIT
 Replaces: 17-44166T1
 For: Bravo I/II/III (1988-02)
 Serial No. 6225577 and up

18-2462
TRIM CYLINDER ANCHOR PIN KIT
 Replaces: 17-14873A1
 For: R/MR/Alpha One (1983-90)
 Serial No. 6225577 and up (Front)

③ This product is priced per piece. To order priced per package, please add -9 to the part number.
 ④ Priced per package



18-2463
TRIM CYLINDER ANCHOR PIN KIT
 Replaces: 17-14872A1
 For: R/MR/Alpha One (1983-90)
 Serial No. 6225577 and up (Rear)



18-2464
FRONT AND REAR ANCHOR PIN KIT
 Replaces: 17-815953T1, 56-864641A24
 For: All Alpha One Gen II



18-7633
TRIM SENDER/LIMIT KIT
 Replaces: 805320A03
 Fits: MC-I, R, MR, Alpha, Alpha Gen II, Bravo drives



18-2142
POWER TRIM CYLINDER
 Replaces: 45706A14
 Fits All Stern Drive Models with internal lines: 120, 140, 160, 165, 888, 898, 228, 225-S, 233, 250, 260,470 & 485



18-2148
POWER TRIM CYLINDER HOUSING
 Replaces: 77442A1
 Fits All Stern Drive Models: 120, 140, 160, 165, 888, 898, 228, 225-S, 233, 250, 260,470 & 485



18-2420
POWER TRIM CYLINDER
 Replaces: 14034A3
 For: R/MR/ALPHA (Starboard)



18-2421
POWER TRIM CYLINDER
 Replaces: 14035A3
 For: R/MR/ALPHA (Port)



18-2422
POWER TRIM CYLINDER
 Replaces: 815935A7
 For: GEN II (Port) (S/N F680000 - UP)



18-2423
POWER TRIM CYLINDER
 Replaces: 81595A7
 For: GEN II (Starboard)
 (S/N F680000 - UP)



18-2424
POWER TRIM CYLINDER
 Replaces: 98703A26
 For: BRAVO (Port)



18-2425
POWER TRIM CYLINDER
 Replaces: 98704A17, 98704A26
 For: BRAVO (Starboard)



18-2426
POWER TRIM CYLINDER
 Replaces: 98703A3
 For: R/MR/ALPHA (Port)



18-2427
POWER TRIM CYLINDER
 Replaces: 98704A3
 For: R/MR/ALPHA (Starboard)



18-2649
POWER TRIM SEAL KIT
 Replaces: 25-87400A2



18-2291
TRIM CYLINDER REPAIR KIT
 Replaces: 25-60342A2
 Fits All Stern Drive Models: 120, 140, 160, 165, 888, 898, 228, 225-S, 233, 250, 260,470 & 485



18-2428
TRIM CYLINDER REPAIR KIT
 Replaces: 87399A2
 For: R/MR/ALPHA I, BRAVO



18-2429
TRIM CYLINDER REPAIR KIT
 Replaces: 87399A3
 For: ALPHA I GEN II

POWER TRIM CYLINDER APPLICATION

Model	Year	Serial Number	Trim Cylinder Port	Trim Cylinder Starboard	Housing Port	Housing Starboard	Trim Cylinder Seal Kit
120/ 140 4cyl, 160 6 cyl	1967- 69	2062141- 2791956	18-2142	18-2142	—	—	—
All #1 Drives ①	1970- 82	2791957- 6225576	18-2142	18-2142	18-2148	18-2148	18-2291
R/ MR/ ALPHA I	1983-90	6225577 & UP	18-2426 ②	18-2427 ②	—	—	18-2649
ALPHA I SS	1986- 89	0A545004 & UP	18-2426 ②	18-2427 ②	—	—	18-2649
R/ MR/ ALPHA I	1983-90	6225577 & UP	18-2421 ③	18-2420 ③	—	—	18-2649
ALPHA I SS	1986- 89	0A545004 & UP	18-2421 ③	18-2420 ③	—	—	18-2649
ALPHA I GEN II	1991-2001	0D469859 & UP	18-2422	18-2423	—	—	18-2649
BRAVO I/ II/ III	1988 & UP	0B664190 & UP	18-2424	18-2425	—	—	18-2649
BLACKHAWK	1994-95	0F186717 & UP	18-2424	18-2425	—	—	18-2649

① Excludes the TR, TRS, 215E, H and early II & III drives ② With 15 9/16" long trim cylinder tube ③ With 16 3/16" long trim cylinder tube

<p>PKG. OF 5</p>  <p>18-4252 18-4252-9⑦ CONTINUITY SPRING Replaces: 24-46312 Grounds the trim cylinder to the pivot pin shaft.</p>	 <p>18-2151 7 1/2" (Front) Replaces: 17-45738</p> <p>18-2152 10 1/2"(Rear) Replaces: 17-45735</p> <p>PIVOT PIN Used on 120, 120-260, 140,165, 225S, 233, 250, 470, 888, 898/228 Use 18-2701 Bushing</p>	 <p>18-2393 TRIM CYLINDER PIVOT PIN For: Trim cylinder rear R/MR/Alpha Use: 18-2702-1 Bushing</p>	 <p>18-2394 TRIM CYLINDER PIVOT PIN For: Trim cylinder front R/MR/Alpha Use: 18-2702-1 Bushing</p>
 <p>18-2395 TRIM CYLINDER PIVOT PIN Replaces: 17-815953 For: Trim cylinder front & rear Gen II</p>	 <p>18-2396 TRIM CYLINDER PIVOT PIN Replaces: 17-44166 For: Rear Bravo</p>	 <p>18-2397 TRIM CYLINDER PIVOT PIN Replaces: 17-44167A1 For: Front Bravo</p>	
 <p>POWER TRIM BUSHING 18-2701⑤ 18-2701-04⑥ 18-2701-9④ Replaces: 23-89574 Fits 120/260 Drive Units (S/N 6225276 & Down)</p>	 <p>POWER TRIM BUSHING 18-2702-1⑤ 18-2702-04⑥ 18-2702-1-9④ Replaces: 23-99291, 23-99291T Fits 120/260 Drive Units (S/N 6225277 & UP)</p>	<p>PKG. OF 8</p>  <p>18-4288 18-4288-9⑦ POWER TRIM BUSHING Replaces: 23-807073 For: Bravo</p>	<p>PKG OF 2</p>  <p>18-2345 18-2345-9⑦ TRIM CYLINDER ANCHOR PIN E-RING Replaces: 53-815949 For: Gen II</p>
<p>PKG. OF 2</p>  <p>18-4289 18-4289-9⑦ RETAINING RING Replaces: 53-805272 For: Bravo</p>	<p>PKG. OF 4</p>  <p>18-2336 18-2336-9⑦ TRIM BUSHING Replaces: 23-90203 For: TR & TRS(1977-93),Alpha One SS (1986-1989) , SSM(1982-1995)</p>	<p>PKG. OF 8</p>  <p>18-2341-1 18-2341-1-9⑦ POWER TRIM BUSHING Replaces: 23-815950, 23-8159501 For: Gen II</p>	<p>PKG OF 5</p>  <p>18-3232 18-3232-9⑦ PLUG Replaces: 19-47579 For: MR Alpha</p>

④ Standard package of 8 priced per piece
⑤ Standard package of 8 priced per package
⑥ Priced per Package of 4
⑦ Priced per Package

Zinc is for saltwater only applications.
 Magnesium is for fresh water only applications.
 Aluminum is for brackish water or salt water environments.

18-6154A
18-6154M
18-6154Z
ANODE KIT
 Bravo III (2004 and Newer)

18-6158M
18-6158Z
18-6158A
ANODE KIT
 Replaces:
 888755Q01 (18-6158M),
 888756Q01 (18-6158A)
 Mercuriser Alpha I Gen II (1991 & UP)

18-6159A
18-6159M
18-6159Z
ANODE KIT
 Replaces:
 888758Q01 (18-6159A),
 888757Q01 (18-6159M)
 Mercuriser Bravo I - All Years

18-6160A
18-6160M
18-6160Z
ANODE KIT
 Replaces:
 888761Q01 (18-6160A),
 888760Q01 (18-6160M)
 Bravo II (1989 & Up), Bravo III (1989-03)

① **18-6117A**
 ② **18-6117M**
 ③ **18-6117Z**
ANODE
 Replaces:
 Mercuriser 806188A1, A2
 For: Bravo One bearing carrier

② **18-6241**
 ③ **18-6011**
 ① **18-6011A**
ANODE
 Replaces: 31640, A1, Q4, T6
 For use on R/MR/Alpha One, Sterndrive &
 Transom Assembly (1983-90) & prior drives,
 Alpha One, Gen II (1991 & up)

③ **18-6012**
ANODE
 Replaces: 34127A1, T2
 For use on R/MR/Alpha One (Sterndrive &
 Transom Assembly 1983-90) & prior drives

③ **18-6013**
ANODE
 Replaces: 34762A1
 For use on Alpha One SS (Sterndrive &
 Transom Assembly 1983-89) & prior drives

③ **18-6014**
 ① **18-6014A**
ANODE
 Replaces:
 46399A1, 822777A1, Q1
 For use on Alpha One SS (1982-89)

PKG OF 2
 ⑥③ **18-6015-9**
 ③⑤ **18-60151-9**
 ⑥① **18-6015A-9**
 ⑥② **18-6242-9**
ANODE
 Replaces: 55989A3, Q9, T9
 Bravo I, II, III (1988-95)

③ **18-6016**
 ③④ **18-60161**
 ③⑤ **18-60161-9**
 ① **18-6016A**
 ② **18-6244**
ANODE
 Replaces: 76214, T3, Q5
 200, 225, 250HP, V-155-V-200, & All
 Bravos, Alpha One, Gen II (1991 & up)

③ **18-6066**
 ① **18-6066A**
 ② **18-6243**
ANODE
 Replaces: 43994A2, 821631Q1
 For use on R/MR/Alpha One (Sterndrive
 & Transom Assembly 1983-90)

① Aluminum ② Magnesium ③ Zinc
 ④ Standard package of 10 priced per piece ⑤ Standard package of 10 priced per package
 ⑥ Standard package of 2 priced per package

Zinc is for saltwater only applications.
Magnesium is for fresh water only applications.
Aluminum is for brackish water or salt water environments.



② 18-6114
③ 18-6067
① 18-6067A
ANODE
Replaces: 806189, A1, Q1, T1
For: Alpha One, Gen II (1991 & up)



③ 18-6068
ANODE
Replaces: 826134, Q
Alpha One (Gen II)



② 18-6099
③ 18-6080
① 18-6080A
ANODE
Replaces: 821629, A1, Q1
For: Alpha One (Gen II) (1991 & UP)



② 18-6089
③ 18-6092
① 18-6092A
ANODE
Replaces: 806190, A1, Q1, T1
All Bravos



② 18-6079
③ 18-6093
① 18-6093A
ANODE
Replaces: 806105, A1, Q1, T1
For: Alpha One (Gen II) (1991 & UP)



① 18-6150A
② 18-6150M
③ 18-6150Z
ANODE KIT
Replaces: 888756Q02
For: MR & Alpha One Drives



② 18-6240
③ 18-6094
① 18-6094A
ANODE
Replaces: 821630, A1, Q1, T1
All Bravos

— CONTAINS —

Part #	Description	O.E. #	Qty.
18-2599	Face Seal and Tool	26-818575A2	1
18-2564	Water Pump Base To Face Plate Gasket	27-43033-1	1
18-2566	Face Plate to Water Pump Cover Gasket	27-817277	1
18-2945	Sealing Washer	12-19183	1
18-2944	Seal	26-45577	1
18-2002	Oil Seal	26-76868	1
18-2013	Oil Seal	26-16977	1
18-2014	Oil Seal	26-89238	1
18-2054	Oil Seal	26-81646-1	1
18-2076	Oil Seal	26-12224	1
18-2077	Oil Seal	26-14077	1
18-7159	O-Ring	25-31534	1
18-7168	O-Ring	25-48171	2
18-7176	O-Ring	25-90011	1
18-7420	O-Ring	25-21836	2
18-7440-1	O-Ring	25-36318	2
18-2056	Oil Seal	26-66302	2
18-7413	O-Ring	25-62702	1



18-2646-1
LOWER UNIT SEAL KIT
Replaces: 26-816575A3
For: Alpha Gen II

— CONTAINS —

Part #	Description	O.E. #	Qty.
18-2516	Bravo Outdrive Seal	16755	1
18-1240	Outdrive Seal	12708	1
18-2945	Gear Housing Drain Screw Gasket	12-19183	1
18-7198	O-Ring	25-45710	1
18-7102	O-Ring	25-62706	1
18-7105	O-Ring	25-62705	1
18-7449	O-Ring	25-97387	1
18-7153	O-Ring	25-25439	2
18-7167	O-Ring	25-97386	1
18-2010	Oil Seal	26-12709	1
18-2715	Spring Kit	24-17997A1	1
18-7117	O-Ring	25-35027	1
18-7169	O-Ring	25-70937	1



18-2643
UPPER UNIT SEAL KIT
Replaces: 26-16709A2
BRAVO - BLACKHAWK

① Aluminum ② Magnesium ③ Zinc ④ Standard package of 10 priced per piece
SEAL KIT APPLICATION BEGINS ON PAGE 737

— CONTAINS —

Part #	Desc.	O.E. #	Qty.
18-2944	Seal Gasket	26-45577	1
18-2945	Drain Screw Gasket	12-19183	3
18-7188	Drain Screw O-Ring	26-805726	1
18-7169	O-Ring	25-70937	1
18-7161	O-Ring	25-32546	1
18-7420	O-Ring	25-25439	2
18-7103	O-Ring	25-29845	2
18-7117	O-Ring	25-35027	1
18-2056	Oil Seal	26-66302	2
18-2003	Oil Seal	26-823894	1
NSS	Water Tube Seal	26-88397	1
18-3289	Double Lip Seal	26-864319	1
18-2715	Spring Kit	24-17997A1	1



18-2644
UPPER UNIT SEAL KIT
 Replaces: 26-88397A1
 ALPHA I GENERATION II

— CONTAINS —

Part #	Description	O.E. #	Qty.
18-2944	Seal Gasket	26-45577	1
18-2945	Gear Housing Drain Screw Gasket	12-19183	1
18-7163	O-Ring	25-33465	1
18-7159	O-Ring	25-31534	1
18-2002	Oil Seal	26-76868	2
18-0563	Seal	26-36556	1

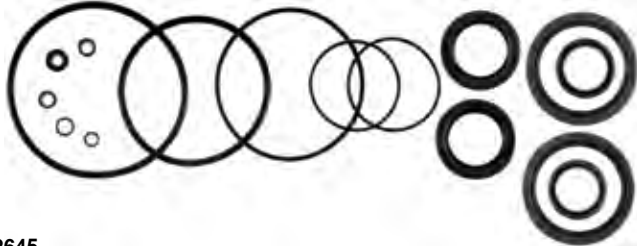

18-2645
LOWER UNIT SEAL KIT
 Replaces: 26-76868A2
 Bravo I and II MODELS ONLY

— CONTAINS —

Part #	Description	O.E. #	Qty.
18-2945	Gear Hsg. Drain Screw Gasket	12-19183	2
18-0894	Water Pocket Cover Gasket	27-55810	1
18-2003	Oil Seal	26-68493	1
18-2049	Oil Seal	26-32511	1
18-2056	Oil Seal	26-96503	1
18-2944	Seal Ring Gasket	26-45577	1
18-3110	Bushing	26-38970	1
18-7153	O-Ring	25-25439	2
18-7161	O-Ring	25-32546	1
18-7169	O-Ring	25-70937	1
18-7445	O-Ring	25-55801	1



18-2648
UPPER UNIT SEAL KIT
 Replaces: 26-32511A1
 S/N 1684188 & UP
 For #1 Units (Including ALPHA) (Also fits 888 Stern drive)
 S/N 3106717 & UP

— CONTAINS —

Part #	Description	O.E. #	Qty.
18-2919	Water Pump to Gear Hsg. Gasket	27-42631-1	1
18-3110	Grommet	26-38970	1
18-2002	Oil Seal	26-76868	1
18-2013	Oil Seal	26-16977	2
18-2014	Oil Seal	26-89238	1
18-2826	Water Pump Base to Gear Hsg. Gasket	27-85610-1	1
18-2914	Lower Water Pump to Wear Plate Gasket	27-85608-1	1
18-2915	Upper Water Pump to Wear Plate Gasket	27-85609-1	1
18-2944	Seal Ring Gasket	26-45577	1
18-2948	Gear Housing Plastic Flush Screw Gasket	12-49221-1	1
18-7158	O-Ring	25-30613	1
18-7159	O-Ring	25-31534	1
18-7162	O-Ring	25-33145	1
18-7176	O-Ring	25-90011	1
—	O-Ring	25-38099	1
18-2154	Bushing, Shift Shaft	23-30617A2	1
18-2076	Line Cutter Oil Seal	26-12224	1
18-7426	O-Ring	25-30271	1
18-2945	Gear Housing Drain Screw Gasket	12-20260, 12-19183	2

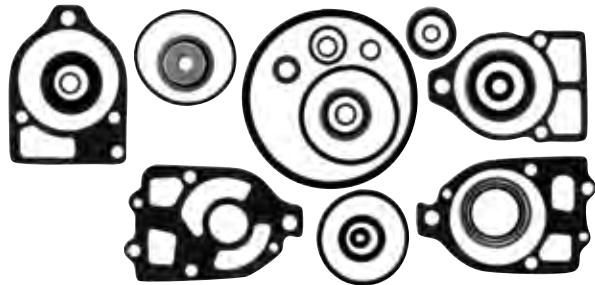

18-2652
LOWER UNIT SEAL KIT
 Replaces: 26-33144A2
 S/N 1684188 & UP
 For #1 Units (Including ALPHA)

— CONTAINS —

Part #	Description	O.E. #	Qty.
18-2652	Lower Gear Housing Seal Kit	26-33144A2	1
18-1155	Ball Bearing	30-88957A1	1
18-1117	Pinion Bearing	31-42647A1	1
18-1143	Tapered Roller Bearing	31-36387A1	1
18-3719	Pinion Nut	11-35921	1
18-2299	Tab Washer	14-79447	1
18-2298	Tab Washer	14-18323	1
18-1158	Needle Roller Bearing	31-30956	1
18-1159	Tapered Roller Bearing	31-35928A1	1
18-2285	Shim Kit	15-47397A1	1
18-1157	Needle Roller Bearing	31-30895	1
18-2343	Washer	12-982721	1
18-2294	Shim Kit	2470	1



18-8208
SEAL & BEARING KIT
 Replaces: 31-803090T1
 For: MR/Alpha Drive

SEAL KIT APPLICATION BEGINS ON NEXT PAGE



18-8370
COMPLETE LOWER GEAR CASE REBUILD KIT
 Includes Water Pump and Complete Seal Kit
 For Mercuriser R/MR/ALPHA 1

--- CONTAINS ---			
Part #	Description	O.E. #	Qty.
18-2340	Shift Shft Rubber Washer	12-31266	1
18-2076	Oil Seal	26-12224	1
18-7159	O-Ring	25-31534	1
18-2002	Oil Seal	26-76868	1
18-3109	Water Tube	23-29804	1
18-2154	Shift Bushing	23-30617A2	1
18-3116	Housing	46-96148A1	1
18-3017	Impeller	47-89984	1
18-2914	Water Pump Gasket	27-85608-1	1
18-7158	O-Ring	25-30613	1
18-7176	O-Ring	25-90011	1
18-2944	Seal Ring Gasket	26-45577	1
18-7173	O-Ring	25-30224	1
18-2826	Water Pump Base to Gear Housing Gasket	27-85610-1	1
18-2915	Water Pump Gasket	27-85609-1	1
18-3117	Plate	32435	1
18-7162	O-Ring	25-33145	1
18-2919	Water Pump Gasket	27-42631-1	1
18-2801	Water Pump Gasket	27-32438	1
18-7426	O-Ring	35-30271	1
18-2945	Drain Gasket	26-20260, 12-19183	2
18-3110	Grommet	26-38970	1
18-2013	Seal	26-16977	1
18-2014	Seal	26-89238	1

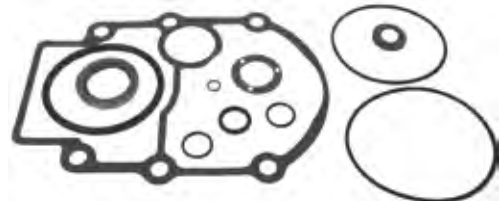

18-8371
UPPER GEARCASE SEAL KIT
 For: TR & TRS Drives

Stern Drive Model	Years	S/N	Bearing Carrier O-Ring	Bearing Carrier Seals	Upper Unit Seal Kit	Lower Unit Seal & Brg. Kit	Lower Unit Seal Kit	U-Joint Carrier Seal
60/80/90	1965-72	1830753 - 3225967	18-7160	18-2011/18-2015	N/A	N/A	N/A	N/A
I	1963	1534570 - 1684187	18-7157	18-2002	18-2648	N/A	18-2652	18-0577
IA, IB, IC & EZ Shift	1964-66	1684188 - 2065189	18-7157	18-2002	18-2648	N/A	18-2652	18-0577
120/140	1967-69	2062141 - 6225576	18-7157	18-2002	18-2648	N/A	18-2652	18-0577
470/485	1976-82	4208730 - 6225576	18-7157	18-2002	18-2648	N/A	18-2652	18-0577
160/165	1967-77	2065190 - UP	18-7157	18-2002	18-2648	N/A	18-2652	18-0577
888	1971-77	3106717 - UP	18-7157	18-2002	18-2648	N/A	18-2652	18-0577
225/233	1974-77	3856268 - UP	18-7157	18-2002	18-2648	N/A	18-2652	18-0577
898/228/250/260	1977-82	4782330 - 4898729	18-7157	18-2002	18-2648	N/A	18-2652	18-0577
R	1983	6225577 - UP	18-7157	18-2002	18-2648	18-8207	18-2652	18-0577
MR / Alpha One	1984-90	6225577 - UP	18-7157	18-2002	18-2648	18-8208	18-2652	18-0577
MR / Alpha One	1984-90	6225577 - UP	18-7157	18-2077/18-2076	18-2648	18-8208	18-2652	18-0577
MR / Alpha One (CR)	1984-90	6225577 - UP	18-7157	18-2077/18-2076	18-2648	—	18-2652	18-0577
Alpha One SS	1986-89	A545004 - UP	18-7157	18-2002	18-2648	—	18-2652	18-0577
Alpha One SS	1986-89	A545004 - UP	18-7157	18-2077/18-2076	18-2648	—	18-2652	18-0577
Alpha One Gen II	1991-95	D469859 - F679999	18-7157	18-2077/18-2076	18-2644	—	18-2646-1	18-0577
Alpha One Gen II (CR)	1991-95	D469859 - F679999	18-7157	18-2077/18-2076	18-2644	—	18-2646-1	18-0577
Alpha One Gen II	1996-97	F680000 - K999999	18-7157	18-2077/18-2076	18-2644	—	18-2646-1	18-0577
Alpha One Gen II (CR)	1996-newer	F680000 - UP	18-7157	18-2077/18-2076	18-2644	—	18-2646-1	18-0577
Alpha One Gen II	1998-newer	L100040 - UP	18-7157	18-2077/18-2076	18-2644	—	18-2646-1	18-0577
Bravo I	1988-newer	B664190 - UP	18-7157	18-2002	18-2643	—	18-2645	—
Bravo II	1988-newer	B664190 - UP	18-7453	18-0536	18-2643	—	18-2645	—
Bravo III	1988-newer	B664190 - UP	18-7447	—	18-2643	—	18-2645	—
Blackhawk	1994-95	F186717 - UP	18-7451	—	18-2643	—	N/A	—
II	1962-69	1474909 - 2671321	18-7157	—	N/A	—	N/A	—
III	1968-72	2373127 - 3002613	—	—	N/A	—	N/A	—
215E/H	1970-72	2909035 - 2915034	18-7453	18-0536	N/A	—	N/A	—
TR	1973-93	3377316 - UP	18-7453	—	18-8371	—	N/A	—
TRS	1973-93	3377316 - UP	18-7157	18-2002	18-8371	—	N/A	—

① Line Cutter Seal



18-4456
EXHAUST PROTECTOR VALVE
 Replaces: 34765A1, 34765A2
 INCLUDES STAINLESS STEEL CLAMP
 3"



18-4457
EXHAUST PROTECTOR VALVE
 Replaces: 12644A1
 INCLUDES STAINLESS STEEL CLAMP
 4"



18-4458
EXHAUST PROTECTOR VALVE
 (Fits both 5" & 6" Exhaust)
 INCLUDES STAINLESS STEEL CLAMP

② Items ending in "D" are Display Packaged - Regular number is Non-Display

OIL SEALS



OIL SEALS

Part #	O.E. #	Shaft Size (inches)	Dimensions		Part #	O.E. #	Shaft Size (inches)	Dimensions	
			O.D.	Width (inches)				O.D.	Width (inches)
18-0172	26-97530	0.845	1.500	0.315	18-2007	26-94038	1.000	1.500	0.312
18-0515	26-30530	0.540	1.004	0.303	18-2008	26-56788	0.875	1.250	0.375
18-0516	26-30913	0.500	0.839	0.187	18-2009	26-89236	0.375	0.750	0.250
18-0517	26-32911	1.100	1.260	0.127	18-2009	26-892361	0.375	0.750	0.250
18-0519	26-14240	3.792	4.536	0.482	18-2010	26-96063	0.437	0.875	0.250
18-0522	26-43036	1.045	1.474	0.187	18-2011	26-90562	0.750	1.250	0.312
18-0523	26-43993	1.640	2.132	0.282	18-2013	26-16977	0.875	1.250	0.188
18-0525	26-45587	0.390	0.628	0.124	18-2014	26-89238	0.875	1.500	0.312
18-0526	26-48443	0.750	1.379	0.256	18-2015	26-23517	0.750	1.250	0.250
18-0527	26-56397	0.750	1.127	0.343	18-2016	26-41953	1.187	1.875	0.250
18-0529	26-62818	1.640	2.256	0.319	18-2017	26-32121	0.750	1.000	0.125
18-0531	26-72785	0.790	1.880	0.248	18-2019	26-27163	0.688	1.124	0.250
18-0537	26-85107	1.020	1.507	0.251	18-2019	26-26805	0.688	1.124	0.250
18-0578	26-67388	1.800	3.100	0.500	18-2026	26-16977	0.875	1.250	0.188
18-2002	26-78868	1.188	1.692	0.250	18-2048	26-24590	0.400	0.566	0.094
18-2003	26-68493	2.250	3.000	0.437	18-2049	26-32511	1.250	2.005	0.388
18-2004	26-20070	0.625	1.000	0.250	18-2050	26-55682	1.000	1.253	0.125
18-2006	26-33467	0.625	1.125	0.312	18-2051	26-69188	0.875	1.253	0.278
					18-2052	26-69189	0.875	1.314	0.322
					18-2053	26-70081	1.185	1.754	0.360
					18-2054	26-816464	0.375	0.750	0.243
					18-2055	26-79831	0.750	1.127	0.149
					18-2056	26-96503	0.885	1.381	0.251
					18-2056	26-965031	0.885	1.381	0.251
					18-2076	26-12224	1.188	1.690	0.360
					18-2077	26-14077	1.188	1.689	0.247

① Line Cutter Seal

DRIVESHAFT HOUSING

Stern Drive Model	Beg. S/N	End. S/N	Oil Seal	Desc.	Qty.	Stern Drive Model	Beg. S/N	End. S/N	Oil Seal	Desc.	Qty.
R/MR/Alpha I	6225577	UP	18-2003	BC	1	250	4791300	4898729	18-2003	BC	1
Alpha I SS		ALL	18-2003	BC	1	250	4791300	4898729	18-2056	LDS	1
Alpha I SS		ALL	18-2056	LDS	1	260	4898730	6225576	18-2049	GC	1
Alpha I SS		ALL	18-2049	GC	1	260	4898730	6225576	18-2056	LDS	1
IA,IB,IC	1684188	2065189	18-2003	BC	1	260	4898730	6225576	18-2003	BC	1
I,IA,IB,IC	1534570	2065189	18-2049	GC	1	470	4208730	6225576	18-2056	LDS	1
IA,IB,IC	1749276	2065189	18-2056	LDS	1	470	4208730	6225576	18-2003	BC	1
II	1474909	2671321	18-2003	BC	1	470	4208730	6225576	18-2049	GC	1
120/140	2062141	6225576	18-2003	BC	1	485	4893835	UP	18-2003	BC	1
120/140	2062141	6225576	18-2056	LDS	1	485	4893835	UP	18-2049	GC	1
120/140	2062141	6225576	18-2049	GC	1	485	4893835	UP	18-2056	LDS	1
160/165	2065190	UP	18-2003	BC	1	888	3106717	UP	18-2056	LDS	1
160/165	2065190	UP	18-2049	GC	1	888	3106717	UP	18-2049	GC	1
160/165	2065190	UP	18-2056	LDS	1	888	3106717	UP	18-2003	BC	1
225-S	3856268	4200499	18-2056	LDS	1	898/228	4782330	6225576	18-2049	GC	1
225-S	3856268	4200499	18-2049	GC	1	898/228	4782330	6225576	18-2003	BC	1
225-S	3856268	4200499	18-2003	BC	1	898/228	4782330	6225576	18-2056	LDS	1
233	4200500	UP	18-2049	GC	1						
233	4200500	UP	18-2003	BC	1						
233	4200500	UP	18-2056	LDS	1						
250	4791300	4898729	18-2049	GC	1						

BC Bearing Carrier Seal
GC Gear Chamber Seal
LDS Lower Driveshaft Seal

GEAR HOUSING

Stern Drive Model	Beg. S/N	End. S/N	Oil Seal	Desc.	Qty.	Stern Drive Model	Beg. S/N	End. S/N	Oil Seal	Desc.	Qty.
MR/Alpha I	6225577	UP	18-2002	PS	2	IA,IB,IC	1684188	2065189	18-2013	WPB	1
R/MR/Alpha I	6225577	UP	18-2009	SSB	1	IA,IB,IC	1684188	2065189	18-2013	WP	1
R/MR/Alpha I	6225577	UP	18-2014	WPB,L	1	IA,IB,IC	1684188	2065189	18-2009	SSB	1
MR/Alpha I	6225577	UP	18-2013	WPB,U	1	TRS	4794900	UP	18-2002	PS	2
R	6225577	UP	18-2013	WPB,U	1	60	1830753	2063740	18-2009	SSB	1
Alpha I SS	ALL		18-2014	WPB,L	1	60	1830753	2063740	18-2011	WPB,L	1
Alpha I SS	ALL		18-2009	SSB	1	60	1830753	2063740	18-2055	WPB,U	1
Alpha I SS	ALL		18-2013	WPB,U	1	60	1830753	2063740	18-2015	PS,O	1
Alpha I SS	ALL		18-2002	PS	2	60	1830753	2063740	18-2011	PS,I	1
BRAVO I	B664190	UP	18-2002	PS	2	80	2063741	2898029	18-2002	PS	2
I	1534570	1536617	18-2009	WPB	1	80	2063741	2898029	18-2009	SSB	1
I	1534570	1684187	18-2009	SSB	1	80	2063741	2898029	18-2055	WPB,U	1
I	1534570	1684187	18-2002	PS	2	80	2063741	2898029	18-2011	WPB,L	1
I	1534570	1684187	18-2013	WP	1	90	2898020	3225967	18-2009	SSB	1
I	1536618	1684187	18-2014	WPB	1	90	2898020	3225967	18-2002	PS	2
I	1563354	1684187	18-2013	WPB	1	90	2898020	3225967	18-2011	WPB,L	1
IA,IB,IC	1684188	2065189	18-2014	WPB	1	90	2898020	3225967	18-2055	WPB,U	1
IA,IB,IC	1684188	2065189	18-2002	PS	2	120/140	2062141	6225576	18-2013	WPB,U	1

GEAR HOUSING (Cont.)											
Stern Drive Model	Beg. S/N	End. S/N	Oil Seal	Desc.	Qty.	Stern Drive Model	Beg. S/N	End. S/N	Oil Seal	Desc.	Qty.
120/140	2062141	4893634	18-2013	WP	1	470	4208730	6225576	18-2009	SSB	1
120/140	2062141	6225576	18-2014	WPB,L	1	470	4208730	6225576	18-2014	WPB,L	1
120/140	2062141	6225576	18-2009	SSB	1	470	4208730	6225576	18-2002	PS	2
120/140	2062141	6225576	18-2002	PS	2	470	4208730	6225576	18-2013	WPB,U	1
160/165	2065190	UP	18-2009	SSB	1	485	4893835	UP	18-2002	PS	2
160/165	2065190	UP	18-2014	WPB,L	1	485	4893835	UP	18-2009	SSB	1
160/165	2065190	UP	18-2002	PS	2	485	4893835	UP	18-2013	WPB,U	1
160/165	2065190	4890459	18-2013	WP	1	485	4893835	UP	18-2014	WPB,L	1
160/165	2065190	UP	18-2013	WPB,U	1	888	3106717	UP	18-2014	WPB,L	1
225-S	3856268	4200499	18-2013	WPB,U	1	888	3106717	UP	18-2009	SSB	1
225-S	3856268	4200499	18-2014	WPB,L	1	888	3106717	UP	18-2013	WP	1
225-S	3856268	4200499	18-2002	PS	2	888	3106717	UP	18-2013	WPB,U	1
225-S	3856268	4200499	18-2009	SSB	1	888	3106717	UP	18-2002	PS	2
233	4200500	UP	18-2009	SSB	1	898/228	4782330	6225576	18-2014	WPB,L	1
233	4200500	UP	18-2013	WPB,U	1	898/228	4782330	6225576	18-2013	WPB,U	1
233	4200500	UP	18-2002	PS	2	898/228	4782330	6225576	18-2009	SSB	1
233	4200500	UP	18-2014	WPB,L	1	898/228	4782330	6225576	18-2002	PS	2
250	4791300	4898729	18-2013	WPB,U	1						
250	4791300	4898729	18-2014	WPB,L	1						
250	4791300	4898729	18-2002	PS	2						
250	4791300	4898729	18-2009	SSB	1						
255-TRS	3377316	4203749	18-2002	PS	2						
260	4898730	6225576	18-2009	SSB	1						
260	4898730	6225576	18-2002	PS	2						
260	4898730	6225576	18-2013	WPB,U	1						
260	4898730	6225576	18-2014	WPB,L	1						
280-TRS	4203750	4895399	18-2002	PS	2						

- PS Prop Shaft Seal
- PS,I Prop Shaft, Inner Seal
- PS,O Prop Shaft, Outer Seal
- SSB Shift Shaft Bushing Seal
- WPB Water Pump Base Seal
- WPB,L Water Pump Base, Lower Seal
- WPB,U Water Pump Base, Upper Seal
- WP Water Pump Body Seal

O-RINGS

Part #	O.E. #	Dimensions		Part #	O.E. #	Dimensions	
		I. D.	Width (inches)			I. D.	Width (inches)
				18-7161	25-32546	3.250	.070
				18-7162	25-33145	2.025	.135
				18-7163	25-33465	2.415	.100
				18-7164	25-33466	1.375	.100
				18-7165	25-45253	.500	.065
				18-7165	25-32509	.500	.065
				18-7166	25-45254	.615	.065
				18-7167	25-97386	3.609	.139
				18-7168	25-48171	.370	.065
				18-7169	25-70937	3.500	.135
18-0175	25-26543	.220	.103	18-7170	25-33504	1.365	.135
18-0858	25-54029	2.425	.103	18-7171	25-30529	1.920	.100
18-0860	25-62700	3.237	.103	18-7172	25-31305	3.250	.135
18-7103	25-29845	.924	.103	18-7173	25-30224	1.875	.135
18-7105	25-62705	.750	.065	18-7174	25-45711	.620	.100
18-7107	25-67202	4.750	.135	18-7175	25-62817	3.750	.270
18-7114	25-23145	1.000	.135	18-7176	25-90011	2.160	.100
18-7115	25-26722	1.735	.135	18-7177	25-53421	2.625	.065
18-7116	25-62704	.360	.100	18-7180	25-26802	.445	.090
18-7117	25-35027	1.046	.139	18-7188	25-805726	.361	.0635
18-7120	25-38933	.215	.065	18-7198	25-45710	1.430	.100
18-7121	25-35029	3.100	.135	18-7411	25-35480	1.250	.100
18-7127	25-F84305	3.315	.35	18-7413	25-62702	.301	.070
18-7134	25-F40342	.500	.100	18-7414	25-64067	1.989	.070
18-7135	25-35276	.750	.135	18-7415	25-64966	3.739	.070
18-7143	25-65936	1.310	.100	18-7419	25-69202	2.675	.103
18-7145	25-64068	.250	.100	18-7420	25-25439	.862	.139
18-7146	25-47632	1.120	.100	18-7421	25-20415	.150	.065
18-7151	25-20081	3.000	.135	18-7426	25-30271	.740	.310
18-7152	25-20863	2.625	.135	18-7440-1	25-36318	.799	.103
18-7153	25-21836	0.862	.103	18-7445	25-55801	.801	.070
18-7155	25-26855	1.620	.135	18-7449	25-97387	4.487	.103
18-7156	25-29439	1.185	.100	18-7459	25-20826	2.234	.139
18-7157	25-29976	3.500	.210	18-7464	25-39695	4.234	.139
18-7158	25-30613	.740	.100	18-7467	25-54030	2.987	.103
18-7159	25-31534	3.855	.210	18-7474	25-94288	1.239	.070
18-7160	25-31986	2.635	.210	18-7961	25-97386	3.650	.135

① PKG. OF 1 ② PKG. OF 5 ③ PKG. OF 2 ④ PKG. OF 3

DRIVESHAFT HOUSING

Stern Drive Model	Beg. S/N	End. S/N	Oil Seal	Desc.	Qty.	Stern Drive Model	Beg. S/N	End. S/N	Oil Seal	Desc.	Qty.
R/MR/Alpha I	6225577	UP	18-7153	UJ	2	233	4200500	UP	18-7169	BC	1
R/MR/Alpha I	6225577	UP	18-7169	BC	1	250	4791300	4898729	18-7153	UJ	2
R/MR/Alpha I	6225577	UP	18-7161	TC	1	250	4791300	4898729	18-7169	BC	1
Alpha I SS	ALL		18-7161	TC	1	250	4791300	4898729	18-7161	TC	1
Alpha I SS	ALL		18-7169	BC	1	255-TRS	3377316	4203749	18-7175	DSH	1
Alpha I SS	ALL		18-7153	UJ	2	260	4898730	6225576	18-7169	DG	1
BRAVO (I/II)	B664190	UP	18-7198	DSH	1	260	4898730	6225576	18-7161	TC	1
BRAVO (I/II)	B664190	UP	18-7153	UJ	2	260	4898730	6225576	18-7170	BH	1
I	1534570	1684187	18-7127	DG	1	260	4898730	6225576	18-7153	UJ	2
I,IA,IB,IC	1534570	1777798	18-7165	USSL	1	280-TRS	4203750	4895399	18-7175	DSH	1
I,IA,IB,IC	1535212	2065189	18-7170	BH	2	470	4208730	6225576	18-7169	BC	1
IA,IB,IC	1684188	2065189	18-7153	UJ	2	470	4208730	6225576	18-7161	TC	1
IA,IB,IC	1684188	2065189	18-7169	BC	1	470	4208730	6225576	18-7153	UJ	2
II	2398798	2671321	18-7153	UJ	2	470	4893835	6225576	18-7170	BH	1
II SSM	ALL		18-7175	DSH	1	485	4893835	UP	18-7161	TC	1
II SSM	ALL		18-7153	UJ	2	485	4893835	UP	18-7170	BH	1
II TR	3377316	4794899	18-7175	DSH	1	485	4893835	UP	18-7153	UJ	2
III/III SSM	ALL		18-7115	FC	1	485	4893835	UP	18-7169	DG	1
IV SSM ①	ALL		18-7115	FC	1	888	3106717	UP	18-7161	TC	1
I/IA/IB/IC	1534570	2065189	18-7161	TC	1	888	3106717	UP	18-7169	BC	1
TR/TRS ③	4794900	UP	18-7153	UJ	2	888	3106717	UP	18-7153	UJ	2
TR/TRS	4794900	UP	18-7175	DSH	1	898/228	4782330	6225576	18-7169	BC	1
120/140	2062141	6225576	18-7161	TC	1	898/228	4782330	6225576	18-7161	TC	1
120/140	2062141	6225576	18-7170	BH	1	898/228	4782330	6225576	18-7153	UJ	2
120/140	2062141	6225576	18-7169	DG	1	898/228	4898730	6225576	18-7170	BH	1
120/140	2062141	6225576	18-7153	UJ	2						
160/165	2065190	UP	18-7170	BH	1	①	1 ST Design				
160/165	2065190	UP	18-7169	DG	1	②	5/8" ID				
160/165	2065190	UP	18-7153	UJ	2	③	With Borg Warner Transmission				
160/165	2065190	UP	18-7161	TC	1	BC	Bearing Carrier Seal				
215H	2782203	2909034	18-7153	UJ	2	BH	Bell Housing Seal				
215H	2782203	2909034	18-7146	PC	1	CC	Crankshaft Cover Seal				
215E ②	2909035	2915034	18-7174	FC	1	DG	Drive Gear Seal				
215E	2909035	2915034	18-7146	CC	1	DSH	Driveshaft Housing Seal				
225-S	3856268	4200499	18-7153	UJ	2	FC	Front Cover Seal				
225-S	3856268	4200499	18-7169	BC	1	PC	Plug Cover Seal				
225-S	3856268	4200499	18-7161	TC	1	TC	Top Cover Seal				
233	4200500	UP	18-7161	TC	1	USSL	Upper Shift Shaft Lever Seal				
233	4200500	UP	18-7153	UJ	2	UJ	U-Joint Yoke Seal				

GEAR HOUSING

Stern Drive Model	Beg. S/N	End. S/N	Oil Seal	Desc.	Qty.	Stern Drive Model	Beg. S/N	End. S/N	Oil Seal	Desc.	Qty.
R/MR/Alpha I	6225577	UP	18-7162	WPB	1	90	2898020	3225967	18-7155	WOAL	1
MR/Alpha I	6225577	UP	18-7176	WPB	1 ②	120/140	2062141	6225576	18-7153	SSB	1
R/MR/Alpha I	6225577	UP	18-7158	UDS	1	120/140	2062141	6225576	18-7158	UDS	1
R/MR/Alpha I	6225577	UP	18-7159	PBH	1	120/140	2062141	6225576	18-7159	PBH	1
R/MR/Alpha I	6225577	UP	18-7153	SSB	1	120/140	2062141	6225576	18-7162	WPB	1
Alpha I SS	ALL		18-7159	PBH	1	120/140	4893635	6225576	18-7114	GH	1 ③
Alpha I SS	ALL		18-7158	UDS	1	160/165	2065190	UP	18-7162	WPB	1
Alpha I SS	ALL		18-7153	SSB	1	160/165	2065190	UP	18-7153	SSB	1
Alpha I SS	ALL		18-7176	WPB	1 ②	160/165	2065190	UP	18-7158	UDS	1
BRAVO I	B664190	UP	18-7159	PBH	1	160/165	2065190	UP	18-7159	PBH	1
BRAVO I/II	B664190	UP	18-7163	GH	1	165	4890460	UP	18-7114	GH	1 ③
I	1534570	1684187	18-7157	PBH	1	225-S	3856268	4200499	18-7153	SSB	1
I	1534570	1536617	18-7153	WPB	1	225-S	3856268	4200499	18-7162	WPB	1
I	1534570	1684187	18-7153	SSB	1	225-S	3856268	4200499	18-7158	UDS	1
I,IA,IB,IC	1534570	2065189	18-7158	UDS	1	225-S	3856268	4200499	18-7159	PBH	1
I,IA,IB,IC	1536618	2065189	18-7162	WPB	1	233	4200500	UP	18-7162	WPB	1
IA,IB,IC	1684188	2065189	18-7159	PBH	1	233	4200500	UP	18-7158	UDS	1
IA,IB,IC	1684188	1777798	18-7153	WPB	1	233	4200500	UP	18-7159	PBH	1
IA,IB,IC	1684188	2065189	18-7153	SSB	1	233	4200500	UP	18-7153	SSB	1
II	1474909	2671321	18-7159	PBH	1	250	4791300	4898729	18-7159	PBH	1
III	ALL		18-7151	BRL	1	250	4791300	4898729	18-7158	UDS	1
III	ALL		18-7174	BRS	1	250	4791300	4898729	18-7162	WPB	1
TRS	4794900	UP	18-7159	PBH	1	250	4791300	4898729	18-7153	SSB	1
60	1830753	2063740	18-7153	SSB	1	255-TRS	3377316	4203749	18-7159	PBH	1
60	1830753	2063740	18-7160	PBH	1	260	4898730	6225576	18-7162	WPB	1
60	1830753	2063740	18-7155	WOAL	1	260	4898730	6225576	18-7159	PBH	1
60	1830753	2063740	18-7114	WOAS	1	260	4898730	6225576	18-7153	SSB	1
80	2063741	2898029	18-7157	PBH	1	260	4898730	6225576	18-7158	UDS	1
80	2063741	2898029	18-7155	WOAL	1	260	4898730	6225576	18-7114	GH	1 ③
80	2063741	2898029	18-7114	WOAS	1	280-TRS	4203750	4895399	18-7159	PBH	1
80	2063741	2898029	18-7153	SSB	1	470	4208730	6225576	18-7159	PBH	1
90	2898020	3225967	18-7114	WOAS	1	470	4208730	6225576	18-7162	WPB	1
90	2898020	3225967	18-7157	PBH	1	470	4208730	6225576	18-7158	UDS	1
90	2898020	3225967	18-7153	SSB	1	470	4208730	6225576	18-7153	SSB	1

⑤ This product is priced per piece. To order priced per package, please add -9 to the part number.

GEAR HOUSING (Cont.)												
Stern Drive Model	Beg. S/N	End. S/N	Oil Seal	Desc.	Qty.	Stern Drive Model	Beg. S/N	End. S/N	Oil Seal	Desc.	Qty.	
470	4893835	6225576	18-7114	GH	1 ③	③	V-8 Engines Only					
485	4893835	UP	18-7158	UDS	1	BRL	Bearing Retainer Large Seal					
485	4893835	UP	18-7162	WPB	1	BRS	Bearing Retainer Small Seal					
485	4893835	UP	18-7153	SSB	1	GH	Gear Housing Seal					
485	4893835	UP	18-7114	GH	1 ③	PGH	Prop Bearing Housing Seal					
485	4893835	UP	18-7159	PBH	1	SSB	Shift Shaft Bushing					
888	3106717	UP	18-7162	WPB	1	UDS	Upper Driveshaft Seal					
888	3106717	UP	18-7158	UDS	1	WOAL	Water & Oil Adapter Large Seal					
888	3106717	UP	18-7153	SSB	1	WOAS	Water & Oil Adapter Small Seal					
888	3106717	UP	18-7159	PBH	1	WPB	Water Pump Base Seal					
898/228	4782330	6225576	18-7158	UDS	1							
898/228	4782330	6225576	18-7153	SSB	1							
898/228	4782330	6225576	18-7159	PBH	1							
898/228	4782330	6225576	18-7162	WPB	1							
898/228	4898730	6225576	18-7114	GH	1 ③							
①	2.019 ID											
②	2.17 ID											

GIMBAL HOUSING

Stern Drive Model	Beg. S/N	End. S/N	Oil Seal	Desc.	Qty.	Stern Drive Model	Beg. S/N	End. S/N	Oil Seal	Desc.	Qty.	
R/MR/Alpha I	6225577	UP	18-7170	BH	1	260	4898730	6225576	18-7152	EE	1	
BRAVO (I/II)	B664190	UP	18-7168	V	2 ①	470	4208730	6225576	18-7152	EE	1	
I	1534570	1641940	18-7165	GHB	2	470	4208730	4893934	18-7170	BH	1	
II	1474909	1475005	18-7151	SL	1	485	4893835	UP	18-7152	EE	1	
II	1602186	2671321	18-7162	GHAS	1	888	3106717	UP	18-7170	BH	1	
II	1732380	2671321	18-7172	GHAL	1	888	3106717	UP	18-7114	GH	1	
III/III SSM/IV		ALL	18-7159	BH	1	888	3106717	UP	18-7152	EE	1	
60	1830753	2063740	18-7172	BH	1	898/228	4782330	4898729	18-7170	BH	1	
80	2063741	2898029	18-7172	BH	1	898/228	4782330	4898729	18-7114	GH	1	
90	2898020	3225967	18-7172	BH	1	898/228	4782330	6225576	18-7152	EE	1	
120/140	2062141	6225576	18-7152	EE	1							
160/165	2065190	UP	18-7152	EE	1	①	With Oil Reservoir					
225-S	3856268	4200499	18-7170	BH	1	BH	Bell Housing Seal					
225-S	3856268	4200499	18-7152	EE	1	EE	Exhaust Elbow Seal					
225-S	3856268	4200499	18-7114	GH	1	GH	Gimbal Housing Seal					
233	4200500	UP	18-7152	EE	1	GHAL	Gimbal Housing Adapter Large Seal					
233	4200500	UP	18-7114	GH	1	GHAS	Gimbal Housing Adapter Small Seal					
233	4200500	UP	18-7170	BH	1	GHB	Gimbal Housing Bolt Seal					
250	4791300	4898729	18-7152	EE	1	SL	Steering Lever Seal					
250	4791300	4898729	18-7114	GH	1	V	Valve Seal					
250	4791300	4898729	18-7170	BH	1							

HYDRAULIC PUMP ASSY

Stern Drive Model	Beg. S/N	End. S/N	Oil Seal	Desc.	Qty.	Stern Drive Model	Beg. S/N	End. S/N	Oil Seal	Desc.	Qty.	
R/MR/Alpha I	6225577	UP	18-7168	CV	4	233	4200500	UP	18-7168	CV	4	
BRAVO (I/II)	B664190	UP	18-7134	ORC	1	255-TRS	3377316	4203749	18-7168	CV	4	
BRAVO (I/II)	B664190	UP	18-7158	ORS	1	260	4898730	6225576	18-7168	CV	4	
II	2398798	2671321	18-7168	CV	4	280-TRS	4203750	4895399	18-7168	CV	4	
II TR	3377316	4794899	18-7168	CV	4	470	4208730	6225576	18-7168	CV	4	
III/III SSM/IV		ALL	18-7168	CV	4	485	4893835	UP	18-7168	CV	4	
TR/TRS	4794900	UP	18-7168	CV	4	888	3106717	UP	18-7168	CV	4	
90	2898020	3225967	18-7168	CV	4	898/228	4898730	6225576	18-7168	CV	4	
120/140	2062141	6225576	18-7168	CV	4							
160/165	2065190	UP	18-7168	CV	4	CV	Control Valve					
215H/E	2782203	2915034	18-7168	CV	4	ORC	Oil Reservoir Connector					
225-S	3856268	4200499	18-7168	CV	4	ORS	Oil Reservoir Switch					

REVERSE LOCK VALVE

Stern Drive Model	Beg. S/N	End. S/N	Oil Seal	Desc.	Qty.	Stern Drive Model	Beg. S/N	End. S/N	Oil Seal	Desc.	Qty.	
R/MR/Alpha I	6225577	UP	18-7174	VC	1	260	4898730	6225576	18-7174	VC	1	
R/MR/Alpha I	6225577	UP	18-7198	V	1	470	4208730	6225576	18-7198	V	1	
II	2398798	2671321	18-7198	V	1	470	4208730	6225576	18-7174	VC	1	
II	2398798	2671321	18-7174	VC	1	485	4893835	UP	18-7174	VC	1	
120/140	2062141	6225576	18-7198	V	1	485	4893835	UP	18-7198	V	1	
120/140	2062141	6225576	18-7174	VC	1	898/228	4782330	6225576	18-7174	VC	1	
160/165	2065190	UP	18-7198	V	1	898/228	4782330	6225576	18-7198	V	1	
160/165	2065190	UP	18-7174	VC	1							
250	4791300	4898729	18-7198	V	1							
250	4791300	4898729	18-7174	VC	1	V	Valve Seal					
260	4898730	6225576	18-7198	V	1	VC	Valve Cover Seal					